

**MDV 50Hz AC Fan Coil Unit
2-Pipe Duct Series
Technical Service Manual(EU)**

Content

1. INTRODUCTION	- 2 -
2. NOMENCLATURE	- 2 -
3. PRODUCT SCHEDULE	- 3 -
4. EXTERNAL APPEARANCE	- 5 -
5. FEATURES.....	- 5 -
6. SPECIFICATIONS.....	- 7 -
7. DIMENSION	- 19 -
8. SOUND LEVELS.....	- 20 -
9. WIRING DIAGRAMS.....	- 39 -
10. CAPACITY TABLES.....	- 41 -
11.STATIC PRESSURE GRAPHS	- 149 -
12.EXPLODED VIEW	- 156 -
13.INSTALLATION	- 165 -
14.ACCESSORIES	- 168 -

1. Introduction

Fan coil unit is a kind of compound device which assemble fan and heat exchanger (coil) together. Fan coil with fresh air supply system is a main type of central air-conditioner system, so it is an important component of AC devices. A cooling (heating) supply system usually consists of fan coil terminals and chilled water system (heated water system).

MDV commercial AC fan coil is designed and manufactured on the base of advanced technology, and utilize qualified galvanized iron as material. Due to its supper-thin design, it has such advantages: beautiful outlook, space saving, easy installation, etc. And the most obvious advantage is that it can decrease the outlet air Temp-difference as low as possible to make room more comfortable, as well as don't decrease cooling capacity output. For the large air flow volume design, it can increase room ventilation frequency, supply more flesh air, and balance room temperature distribution. Benefiting from adoption of advanced material and technology, it can effectively decrease the running noise and keep running smoothly. With the advantages above, it can be widely applied in market, hospital, office building, hotel, airport, etc.

2. Nomenclature

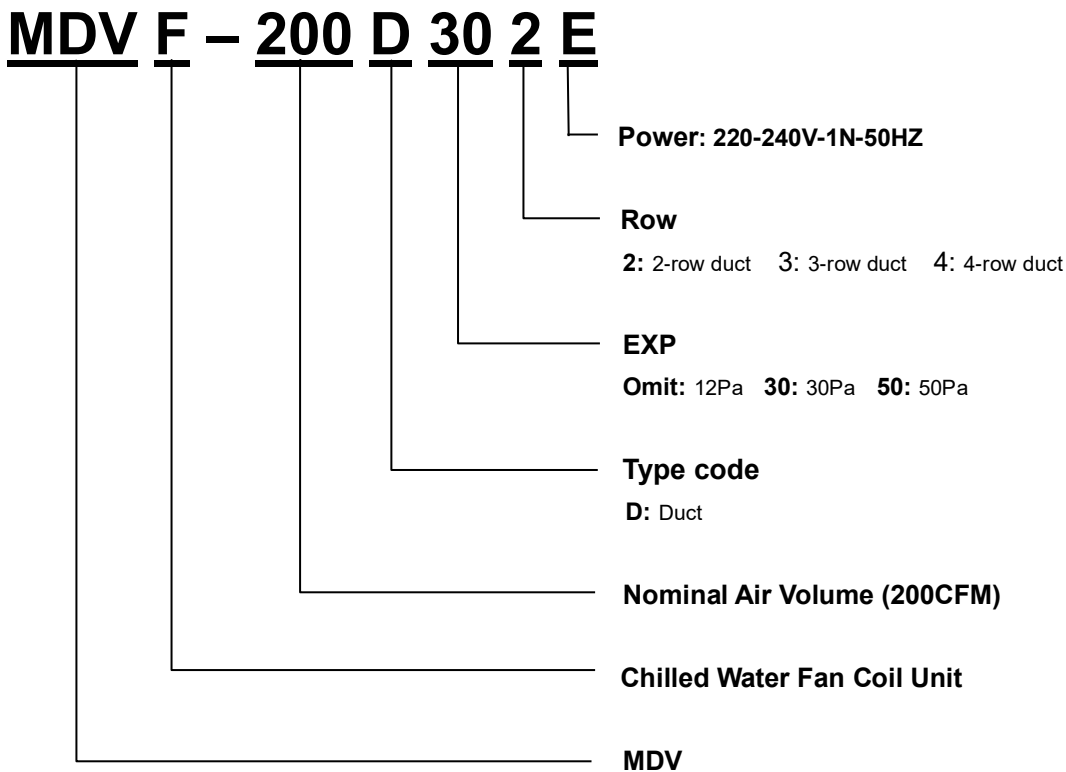

3. Product Schedule

Series	Model	Air volume (CFM)	External static pressure (Pa)	Power supply
2-row Duct	MDVF-200D302E	200	30	220~240V-1Ph-50Hz
	MDVF-300D302E	300		
	MDVF-400D302E	400		
	MDVF-500D302E	500		
	MDVF-600D302E	600		
	MDVF-800D302E	800		
	MDVF-1000D302E	1000		
	MDVF-1200D302E	1200		
	MDVF-1400D302E	1400		
3-row Duct	MDVF-200D3E	200	12	220~240V-1Ph-50Hz
	MDVF-300D3E	300		
	MDVF-400D3E	400		
	MDVF-500D3E	500		
	MDVF-600D3E	600		
	MDVF-800D3E	800		
	MDVF-1000D3E	1000		
	MDVF-1200D3E	1200		
	MDVF-1400D3E	1400		

Series	Model	Air volume (CFM)	External static pressure (Pa)	Power supply
3-row Duct	MDVF-200D303E	200	30	220~240V-1Ph-50Hz
	MDVF-300D303E	300		
	MDVF-400D303E	400		
	MDVF-500D303E	500		
	MDVF-600D303E	600		
	MDVF-800D303E	800		
	MDVF-1000D303E	1000		
	MDVF-1200D303E	1200		
	MDVF-1400D303E	1400		

Series	Model	Air volume (CFM)	External static pressure (Pa)	Power supply
4-row Duct	MDVF-200D304E	200	30	220~240V-1Ph-50Hz
	MDVF-300D304E	300		
	MDVF-400D304E	400		
	MDVF-500D304E	500		
	MDVF-600D304E	600		
	MDVF-800D304E	800		
	MDVF-1000D304E	1000		
	MDVF-1200D304E	1200		
	MDVF-1400D304E	1400		

Note: The units in the table are standard. For the 2-row duct unit, factory-installed electric heater for 12Pa static pressure units can be customized. For the 3-row duct 50Pa static pressure can be customized, and factory-installed electric heater for all the units can be customized.

4. External Appearance

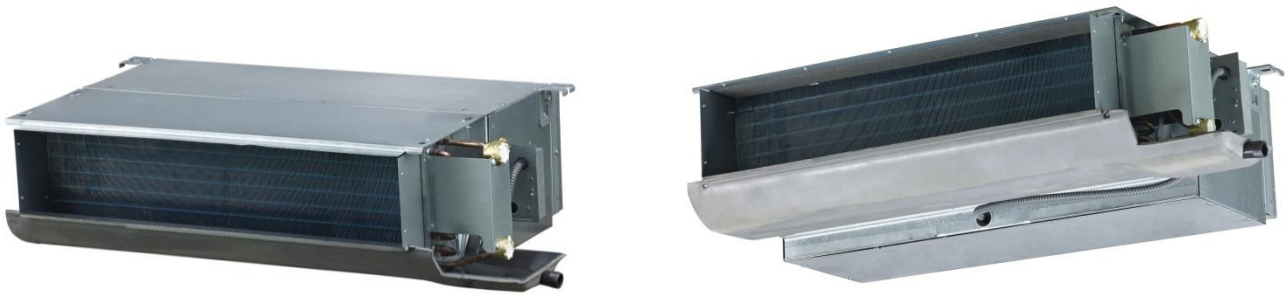

5. Features

◆ Wide external static pressure supplying.

For 2-row unit, two external static pressure (12Pa/30Pa) setting for added flexibility.

For 3-row and 4-row unit, 12Pa and 30Pa ESP are standard, 50 Pa can be customized.

◆ Left or right hand piping connections, field convertible.

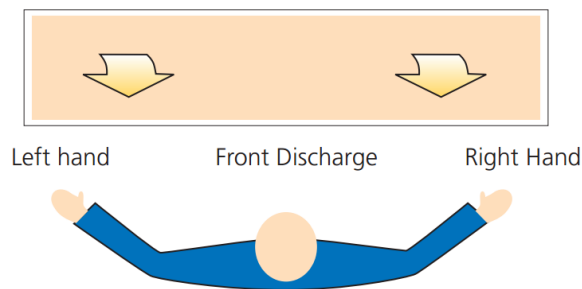

◆ Quiet operation.

A patent design is able to prevent abnormal noise caused by blowing fins.

◆ Superior air distribution

As the conditioned air can be distributed to every corner of the area by air duct, this will ensure more pleasant living environment, thus provide extra comfort to the occupants.

◆ Fresh air supply makes life healthier and more comfortable

◆ Air return plenum

Units with air return plenum is standard and units without air return plenum can be customized.

◆ V type drain pan

Diversion trench and sunk collecting basin design making better drainage. Longer length of V type drain pan can better receive the drain ,water dripping from the water piping and valve connection.

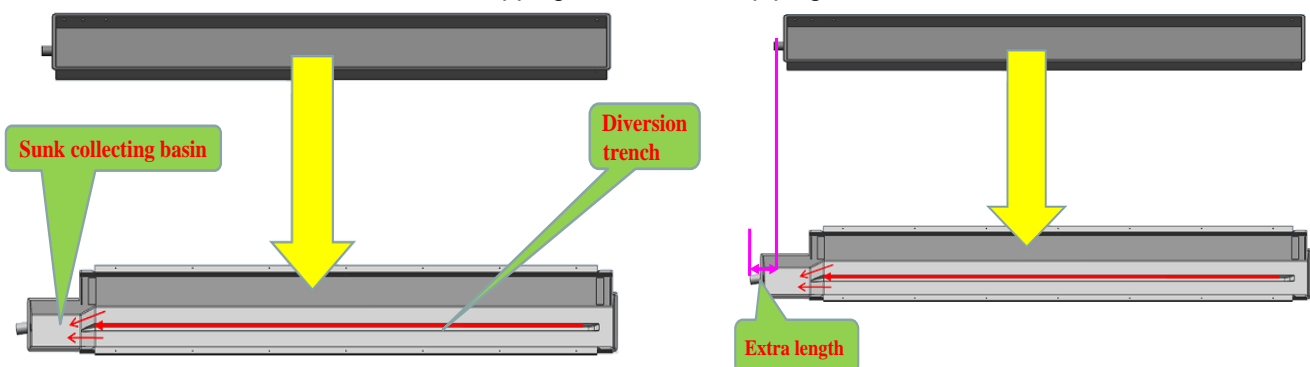

The performance is improved for larger air outlet area.

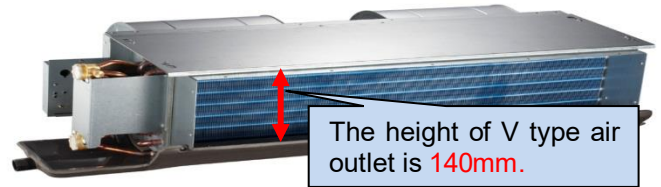

◆ **Electric heater**

Safe factory-installed electric heater is an option for unit.

◆ **Washable filter**

Iron frame filter is standard, and aluminum frame filter can be customized.

Air outlet flange and multi-direction pull-out filter can be customized.

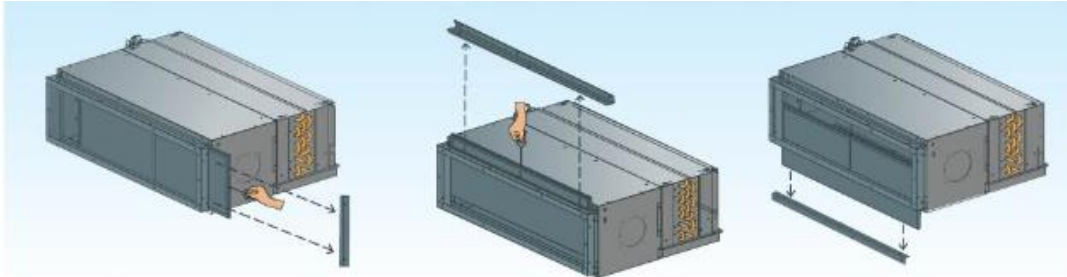

◆ **Optional wired controller**

Optional wired controller offers simple and flexibility in controlling the unit.

◆ **Wide application area**

220-240V/1Ph/50Hz power supply is standard and 208-230V/1Ph/60Hz can be customized.

6. Specifications

2-row Duct

Model MDVF			200D302E	300D302E	400D302E	
Power supply		V/Ph/Hz	220-240/1/50			
Air flow (H/M/L)		m ³ /h	434/354/264	632/483/366	802/648/512	
		CFM	255/208/155	372/284/215	472/381/301	
Standard external static pressure		Pa	G30 models: 30			
Cooling	Capacity (H/M/L)	kW	2.03/1.7/1.4	2.82/2.29/1.89	3.2/2.72/2.34	
	Water flow rate(H/M/L)	m ³ /h	0.36/0.31/0.25	0.51/0.41/0.34	0.58/0.49/0.42	
	Water pressure drop(H/M/L)	kPa	11.9/11.1/9.2	19.8/14.5/10.5	26/20.3/15.7	
Heating	Capacity (H/M/L)	kW	2.55/2.09/1.67	3.39/2.76/2.25	4.02/3.41/2.9	
	Water flow rate(H/M/L)	m ³ /h	0.46/0.38/0.3	0.62/0.5/0.41	0.73/0.62/0.53	
	Water pressure drop(H/M/L)	kPa	9.5/7/4.8	21.8/15.9/10.9	29.9/23.3/17.3	
Power input		W	55/51/45	79/64/53	92/80/69	
Current input		A	0.21	0.28	0.31	
Sound pressure level	H/M/L	dB(A)	41/37/31	41/37/32	42/39/33	
Fan motor	Type		Low noise 4-speed fan motor			
	Quantity		1	1	1	
Fan	Type		Centrifugal, forward-curved Blades			
	Quantity		1	2	2	
Coil	Row		2	2	2	
	Max. working pressure	MPa	1.6	1.6	1.6	
	Diameter		mm	Φ9.52	Φ9.52	Φ9.52
Body	Dimensions	W×H×D mm	741×241×522	841×241×522	941×241×522	
	Packing	W×H×D mm	790×260×550	890×260×550	990×260×550	
	Net weight		kg	13.9	16.5	19.2
	Gross weight		kg	16.2	19	21.6
Pipe connection	Water inlet/outlet pipe		inch	RC3/4	RC3/4	RC3/4
	Drain pipe		inch	R3/4	R3/4	R3/4

Notes:

1. H: high fan speed; M: medium fan speed; L: low fan speed
2. The data is based on 0Pa external static pressure.
3. Cooling conditions: entering water 7°C, temperature rise 5°C, entering air temperature 27°C DB, 19°C WB.
4. Heating conditions: Entering water 45°C, leaving water 40° C, Entering air temperature 20°C DB
5. Noise is tested in a semi-anechoic test room.

2-row Duct

Nodel MDVF-			500D302E	600D302E	800D302E	
Power supply		V/Ph/Hz	220-240/1/50			
Air flow (H/M/L)		m ³ /h	960/775/582	1166/906/703	1463/1128/859	
		CFM	565/456/342	686/533/414	860/664/506	
Standard external static pressure		Pa	G30 models: 30			
Cooling	Capacity (H/M/L)	kW	3.9/3.44/2.88	4.92/4.14/3.52	6.6/5.47/4.45	
	Water flow rate(H/M/L)	m ³ /h	0.7/0.62/0.52	0.89/0.75/0.63	1.19/0.98/0.8	
	Water pressure drop(H/M/L)	kPa	34.3/27.4/20.5	18.5/14.8/11.2	19.8/14.5/10.7	
Heating	Capacity (H/M/L)	kW	4.79/4.06/3.35	6.13/5.13/4.19	7.95/6.58/5.32	
	Water flow rate(H/M/L)	m ³ /h	0.87/0.74/0.61	1.12/0.93/0.76	1.44/1.2/0.97	
	Water pressure drop(H/M/L)	kPa	39.7/31.4/22.4	25.3/19.4/14.2	23.6/15.6/12.8	
Power input		W	119/96/76	141/119/103	167/134/113	
Current input		A	0.41	0.5	0.59	
Sound pressure level	H/M/L	dB(A)	45/41/34	46/41/35	46/41/36	
Fan motor	Type		Low noise 4-speed fan motor			
	Quantity		1	1	2	
Fan	Type		Centrifugal, forward-curved Blades			
	Quantity		2	2	4	
Coil	Row		2	2	2	
	Max. working pressure	MPa	1.6	1.6	1.6	
	Diameter		mm	Φ9.52	Φ9.52	Φ9.52
Body	Dimensions	W×H×D mm	941×241×522	1161×241×522	1461×241×522	
	Packing	W×H×D mm	990×260×550	1210×260×550	1510×260×550	
	Net weight		kg	19.2	22	30.9
	Gross weight		kg	21.6	25	34.5
Pipe connection	Water inlet/outlet pipe		inch	RC3/4	RC3/4	RC3/4
	Drain pipe		inch	R3/4	R3/4	R3/4

Notes:

1. H: high fan speed; M: medium fan speed; L: low fan speed
2. The data is based on 0Pa external static pressure.
3. Cooling conditions: entering water 7°C, temperature rise 5°C, entering air temperature 27°C DB, 19°C WB.
4. Heating conditions: entering water 45°C, leaving water 40°C, Entering air temperature 20°C DB.
5. Noise is tested in semi-anechoic test room.

2-row Duct

Model MDVF-			1000D302E	1200D302E	1400D302E	
Power supply		V/Ph/Hz	220-240/1/50			
Air flow (H/M/L)		m ³ /h	1800/1374/997	2271/1642/1089	2327/1767/1190	
		CFM	1059/808/587	1336/966/641	1369/1039/700	
Standard external static pressure		Pa	G30 models: 30			
Cooling	Capacity (H/M/L)	kW	7.82/6.44/5.34	9.85/8.67/6.13	10.89/9.49/7.49	
	Water flow rate(H/M/L)	m ³ /h	1.41/1.16/0.96	1.77/1.56/1.1	1.96/1.71/1.35	
	Water pressure drop(H/M/L)	kPa	30.5/22.4/16.1	59.6/48.5/26.4	60.9/47.8/31.9	
Heating	Capacity (H/M/L)	kW	9.36/7.76/6.21	12.04/9.89/6.84	12.66/10.92/8.14	
	Water flow rate(H/M/L)	m ³ /h	1.7/1.41/1.13	2.19/1.8/1.24	2.3/1.99/1.48	
	Water pressure drop(H/M/L)	kPa	33/24.8/17.5	75.2/60.3/31.6	58.2/45.2/27.5	
Power input		W	231/191/168	278/229/176	304/233/195	
Current input		A	0.78	0.97	1.13	
Sound pressure level	H/M/L	dB(A)	47/43/37	48/44/38	49/44/39	
Fan motor	Type		Low noise 4-speed fan motor			
	Quantity		2	2	2	
Fan	Type		Centrifugal, forward-curved Blades			
	Quantity		4	4	4	
Coil	Row		2	2	2	
	Max. working pressure	MPa	1.6	1.6	1.6	
	Diameter		mm	Φ9.52	Φ9.52	Φ9.52
Body	Dimensions	W×H×D	mm	1566×241×522	1856×241×522	2022×241×522
	Packing	W×H×D	mm	1615×260×550	1905×260×550	2070×260×550
	Net weight		kg	33.4	38.5	42.1
	Gross weight		kg	37	42	47.5
Pipe connection	Water inlet/outlet pipe		inch	RC3/4	RC3/4	RC3/4
	Drain pipe		inch	R3/4	R3/4	R3/4

Notes:

1. H: high fan speed; M: medium fan speed; L: low fan speed
2. The data is based on 0Pa external static pressure.
3. Cooling conditions: entering water 7°C, temperature rise 5°C, entering air temperature 27°C DB, 19°C WB.
4. Heating conditions: entering water 45°C, leaving water 40° C, Entering air temperature 20°C DB..
5. Noise is tested in semi-anechoic test room.

3-row Duct

Model MDVF-			200D3E	300D3E	400D3E	
Power supply		V/Ph/Hz	220-240/1/50			
Air flow (H/M/L)		m ³ /h	401/363/300	576/467/391	824/642/402	
		CFM	236/213/176	339/274/230	484/378/237	
Standard external static pressure		Pa	G12 models: 12			
Cooling	Capacity (H/M/L)		kW	1.97/1.84/1.57	2.93/2.51/2.21	3.95/3.4/2.43
	Water flow rate(H/M/L)		m ³ /h	0.35/0.33/0.28	0.53/0.45/0.4	0.71/0.61/0.44
	Water pressure drop(H/M/L)		kPa	17.7/15.9/11.9	41/31.6/25.5	30.3/23/14.6
Heating	Capacity (H/M/L)		kW	2.39/2.23/1.74	3.45/2.94/2.57	4.5/3.71/2.66
	Water flow rate(H/M/L)		m ³ /h	0.43/0.41/0.32	0.63/0.53/0.47	0.82/0.67/0.48
	Water pressure drop(H/M/L)		kPa	20.6/18.8/13.9	46.7/33.7/26.7	31/24.9/15.1
Power input(H/M/L)		W	40/37/33	63/52/45	101/87/74	
Current Input(H)		H	A	0.14	0.23	0.29
Sound	12Pa	H/M/L	dB(A)	35/32/26	36/33/27	37/34/28
Fan motor	Type		Low noise 4-speed fan motor			
	Quantity		1	1	1	
Fan	Type		Centrifugal, forward-curved Blades			
	Quantity		1	2	2	
Coil	Row		3	3	3	
	Max. working pressure		MPa	1.6	1.6	1.6
	Diameter		mm	Φ9.52	Φ9.52	Φ9.52
Body	Dimensions	W×H×D	mm	741×241×522	841×241×522	941×241×522
	Packing	W×H×D	mm	790×260×550	890×260×550	990×260×550
	Net weight		kg	14.6	17	20.2
	Gross weight		kg	16.9	19.5	22.6
Pipe connection	Water inlet/outlet pipe		inch	RC3/4	RC3/4	RC3/4
	Drain pipe		inch	R3/4	R3/4	R3/4

Notes:

1. H: high fan speed; M: medium fan speed; L: low fan speed
2. The data is based on 0Pa external static pressure.
3. Cooling conditions: entering water 7°C, temperature rise 5°C, entering air temperature 27°C DB, 19°C WB.
4. Heating conditions: entering water 45°C, leaving water 40° C, Entering air temperature 20°C DB...
5. Noise is tested in semi-anechoic test room.

3-row Duct

Model MDVF-			500D3E	600D3E	800D3E	
Power supply		V/Ph/Hz	220-240/1/50			
Air flow (H/M/L)		m ³ /h	898/652/419	1046/759/513	1362/1031/724	
		CFM	528/384/246	615/446/302	801/607/426	
Standard external static pressure		Pa	G12 models: 12			
Cooling	Capacity (H/M/L)		kW	4.39/3.51/2.73	5.77/4.57/3.36	7.99/6.68/4.8
	Water flow rate(H/M/L)		m ³ /h	0.79/0.63/0.49	1.04/0.82/0.61	1.44/1.2/0.86
	Water pressure drop(H/M/L)		kPa	32/20.7/11.3	67/44.3/25.8	38.8/27.8/18.1
Heating	Capacity (H/M/L)		kW	4.9/3.89/2.78	6.13/4.86/3.56	8.88/7.24/5.48
	Water flow rate(H/M/L)		m ³ /h	0.89/0.71/0.5	1.11/0.88/0.65	1.61/1.32/1
	Water pressure drop(H/M/L)		kPa	35.3/20.1/11.3	60.7/40.2/22.7	37.3/26/15.7
Power input(H/M/L)		W	101/85/70	124/101/83	154/120/98	
Current Input(H)		H	A	0.38	0.43	0.66
Sound	12Pa	H/M/L	dB(A)	40/36/30	42/38/32	43/39/33
Fan motor	Type		Low noise 4-speed fan motor			
	Quantity		1	1	2	
Fan	Type		Centrifugal, forward-curved Blades			
	Quantity		2	2	4	
Coil	Row		3	3	3	
	Max. working pressure		MPa	1.6	1.6	1.6
	Diameter		mm	Φ9.52	Φ9.52	Φ9.52
Body	Dimensions	W×H×D	mm	941×241×522	1161×241×522	1461×241×522
	Packing	W×H×D	mm	990×260×550	1210×260×550	1510×260×550
	Net weight		kg	20.2	23	31.9
	Gross weight		kg	22.6	26	35.5
Pipe connection	Water inlet/outlet pipe		inch	RC3/4	RC3/4	RC3/4
	Drain pipe		inch	R3/4	R3/4	R3/4

Notes:

1. H: high fan speed; M: medium fan speed; L: low fan speed
2. The data is based on 0Pa external static pressure.
3. Cooling conditions: entering water 7°C, temperature rise 5°C, entering air temperature 27°C DB, 19°C WB.
4. Heating conditions: entering water 45°C, leaving water 40°C, Entering air temperature 20°C DB.
5. Noise is tested in semi-anechoic test room.

3-row Duct

Model MDVF-			1000D3E	1200D3E	1400D3E	
Power supply		V/Ph/Hz	220-240/1/50			
Air flow (H/M/L)		m ³ /h	1697/1232/844	2121/1471/972	2541/1965/1123	
		CFM	998/725/496	1248/865/572	1495/1156/661	
Standard external static pressure		Pa	G12 models: 12			
Cooling	Capacity (H/M/L)		kW	8.45/6.74/4.99	10.66/8.23/5.94	13.18/11.36/7.77
	Water flow rate(H/M/L)		m ³ /h	1.52/1.21/0.9	1.92/1.48/1.07	2.37/2.04/1.4
	Water pressure drop(H/M/L)		kPa	46/30.9/18	48/30.6/17	57.1/45.2/22.4
Heating	Capacity (H/M/L)		kW	9.29/7.41/5.56	11.35/8.77/6.42	15.36/12.72/8.29
	Water flow rate(H/M/L)		m ³ /h	1.69/1.35/1.01	2.06/1.59/1.17	2.79/2.31/1.51
	Water pressure drop(H/M/L)		kPa	45.3/30.5/17.9	44.5/28/16.1	60.9/46.7/20.7
Power input(H/M/L)		W	202/168/141	250/197/163	273/224/175	
Current Input(H)		H	A	0.78	0.91	0.97
Sound	12Pa	H/M/L	dB(A)	45/41/35	46/42/36	48/44/38
Fan motor	Type		Low noise 4-speed fan motor			
	Quantity		2	2	2	
Fan	Type		Centrifugal, forward-curved Blades			
	Quantity		4	4	4	
Coil	Row		3	3	3	
	Max. working pressure		MPa	1.6	1.6	1.6
	Diameter		mm	Φ9.52	Φ9.52	Φ9.52
Body	Dimensions	W×H×D	mm	1566×241×522	1856×241×522	2022×241×522
	Packing	W×H×D	mm	1615×260×550	1905×260×550	2070×260×550
	Net weight		kg	34.4	39.5	43.1
	Gross weight		kg	38.1	43	48.4
Pipe connection	Water inlet/outlet pipe		inch	RC3/4	RC3/4	RC3/4
	Drain pipe		inch	R3/4	R3/4	R3/4

Notes:

1. H: high fan speed; M: medium fan speed; L: low fan speed
2. The data is based on 0Pa external static pressure.
3. Cooling conditions: entering water 7°C, temperature rise 5°C, entering air temperature 27°C DB, 19°C WB.
4. Heating conditions: entering water 45°C, leaving water 40° C, Entering air temperature 20°C DB.
5. Noise is tested in semi-anechoic test room.

3-row Duct

Model MDVF-			200D304E	300D304E	400D304E	
Power supply		V/Ph/Hz	220-240/1/50			
Air flow (H/M/L)		m ³ /h	472/375/294	575/455/338	787/648/469	
		CFM	278/221/173	338/268/199	463/381/276	
Standard external static pressure		Pa	G30 models: 30			
Cooling	Capacity (H/M/L)		kW	2.21/1.86/1.55	2.92/2.49/1.97	4.05/3.52/2.72
	Water flow rate(H/M/L)		m ³ /h	0.4/0.34/0.28	0.53/0.45/0.36	0.73/0.63/0.49
	Water pressure drop(H/M/L)		kPa	21.4/15.9/11.9	41/31.6/21	29.2/23/14.6
Heating	Capacity (H/M/L)		kW	2.68/2.27/1.9	3.45/2.89/2.3	4.6/3.99/3.11
	Water flow rate(H/M/L)		m ³ /h	0.49/0.41/0.35	0.63/0.52/0.42	0.84/0.73/0.57
	Water pressure drop(H/M/L)		kPa	25.3/18.8/13.9	46.7/33.7/22.5	30.3/24.3/15.1
Power input(H/M/L)		W	63/54/47	84/72/62	97/90/80	
Current Input(H)		H	A	0.14	0.23	0.29
Sound	12Pa	H/M/L	dB(A)	35/32/26	36/33/27	37/34/28
Fan motor	Type		Low noise 4-speed fan motor			
	Quantity		1	1	1	
Fan	Type		Centrifugal, forward-curved Blades			
	Quantity		1	2	2	
Coil	Row		3	3	3	
	Max. working pressure		MPa	1.6	1.6	1.6
	Diameter		mm	Φ9.52	Φ9.52	Φ9.52
Body	Dimensions	W×H×D	mm	741×241×522	841×241×522	941×241×522
	Packing	W×H×D	mm	790×260×550	890×260×550	990×260×550
	Net weight		kg	14.6	17	20.2
	Gross weight		kg	16.9	19.5	22.6
Pipe connection	Water inlet/outlet pipe		inch	RC3/4	RC3/4	RC3/4
	Drain pipe		inch	R3/4	R3/4	R3/4

Note:

1. H: high fan speed; M: medium fan speed; L: low fan speed
2. The data is based on 0Pa external static pressure.
3. Cooling conditions: entering water 7°C, temperature rise 5°C, entering air temperature 27°C DB, 19°C WB.
4. Heating conditions: entering water 45°C, leaving water 40°C, Entering air temperature 20°C DB.
5. Noise is tested in semi-anechoic test room.

3-row Duct

Model MDVF-			500D304E	600D304E	800D304E	
Power supply		V/Ph/Hz	220-240/1/50			
Air flow (H/M/L)		m ³ /h	1014/764/552	1191/971/763	1454/1166/861	
		CFM	596/450/325	701/571/449	855/686/506	
Standard external static pressure		Pa	G30 models: 30			
Cooling	Capacity (H/M/L)		kW	5.12/4.37/3.55	6.49/5.68/4.74	8.31/7.1/5.66
	Water flow rate(H/M/L)		m ³ /h	0.92/0.79/0.64	1.17/1.02/0.85	1.5/1.28/1.02
	Water pressure drop(H/M/L)		kPa	23.2/17.8/12.2	80.5/64.6/46.2	76.8/57.5/38.6
Heating	Capacity (H/M/L)		kW	6.12/4.98/3.9	6.97/6.05/5.05	8.53/7.31/5.85
	Water flow rate(H/M/L)		m ³ /h	1.11/0.9/0.71	1.27/1.1/0.92	1.55/1.33/1.06
	Water pressure drop(H/M/L)		kPa	26.5/18.2/11.8	75.4/59.7/42.8	65/51.5/33.7
Power input(H/M/L)		W	142/90/77	135/120/108	178/163/145	
Current Input(H)		H	A	0.38	0.43	0.66
Sound	12Pa	H/M/L	dB(A)	40/36/30	42/38/32	43/39/33
Fan motor	Type		Low noise 4-speed fan motor			
	Quantity		1	1	2	
Fan	Type		Centrifugal, forward-curved Blades			
	Quantity		2	2	4	
Coil	Row		3	3	3	
	Max. working pressure		MPa	1.6	1.6	1.6
	Diameter		mm	Φ9.52	Φ9.52	Φ9.52
Body	Dimensions	W×H×D	mm	941×241×522	1161×241×522	1461×241×522
	Packing	W×H×D	mm	990×260×550	1210×260×550	1510×260×550
	Net weight		kg	20.2	23	31.9
	Gross weight		kg	22.6	26	35.5
Pipe connection	Water inlet/outlet pipe		inch	RC3/4	RC3/4	RC3/4
	Drain pipe		inch	R3/4	R3/4	R3/4

Note:

1. H: high fan speed; M: medium fan speed; L: low fan speed.
2. The data is based on 0Pa external static pressure.
3. Cooling conditions: entering water 7°C, temperature rise 5°C, entering air temperature 27°C DB, 19°C WB.
4. Heating conditions: entering water 45°C, leaving water 40°C, Entering air temperature 20°C DB.
5. Noise is tested in semi-anechoic test room.

3-row Duct

Model MDVF-			1000D304E	1200D304E	1400D304E	
Power supply		V/Ph/Hz	220-240/1/50			
Air flow (H/M/L)		m ³ /h	1865/1454/1062	2272/1840/1160	2680/1975/1192	
		CFM	1097/855/625	1336/1082/682	1577/1162/701	
Standard external static pressure		Pa	G30 models: 30			
Cooling	Capacity (H/M/L)		kW	8.84/7.49/5.96	10.98/9.5/7.19	13.53/11.38/7.83
	Water flow rate(H/M/L)		m ³ /h	1.59/1.35/1.07	1.98/1.71/1.29	2.44/2.05/1.41
	Water pressure drop(H/M/L)		kPa	48.2/36.1/24.3	48.9/38/23.5	58.9/44.5/21.7
Heating	Capacity (H/M/L)		kW	9.88/8.34/6.63	11.89/10.32/7.8	15.7/12.53/8.2
	Water flow rate(H/M/L)		m ³ /h	1.8/1.52/1.21	2.16/1.88/1.42	2.85/2.28/1.49
	Water pressure drop(H/M/L)		kPa	50.3/38/24.8	48.5/38.6/23.2	62.2/43.4/21.6
Power input(H/M/L)		W	220/179/153	267/222/180	319/222/174	
Current Input(H)		H	A	0.78	0.91	0.97
Sound	12Pa	H/M/L	dB(A)	45/41/35	46/42/36	48/44/38
Fan motor	Type		Low noise 4-speed fan motor			
	Quantity		2	2	2	
Fan	Type		Centrifugal, forward-curved Blades			
	Quantity		4	4	4	
Coil	Row		3	3	3	
	Max. working pressure		MPa	1.6	1.6	1.6
	Diameter		mm	Φ9.52	Φ9.52	Φ9.52
Body	Dimensions	W×H×D	mm	1566×241×522	1856×241×522	2022×241×522
	Packing	W×H×D	mm	1615×260×550	1905×260×550	2070×260×550
	Net weight		kg	34.4	39.5	43.1
	Gross weight		kg	38.1	43	48.4
Pipe connection	Water inlet/outlet pipe		inch	RC3/4	RC3/4	RC3/4
	Drain pipe		inch	R3/4	R3/4	R3/4

Note:

1. H: high fan speed; M: medium fan speed; L: low fan speed
2. The data is based on 0Pa external static pressure.
3. Cooling conditions: entering water 7°C, temperature rise 5°C, entering air temperature 27°C DB, 19°C WB.
4. Heating conditions: entering water 45°C, leaving water 40°C, Entering air temperature 20°C DB.
5. Noise is tested in semi-anechoic test room.

4-row Duct

Model MDVF-			200D304E	300D304E	400D304E	
Power supply		V/Ph/Hz	220-240/1/50			
Air flow (H/M/L)		m ³ /h	452/369/275	639/494/373	784/634/500	
		CFM	266/217/162	376/290/220	461/373/294	
Standard external static pressure		Pa	30	30	30	
Cooling	Capacity (H/M/L)		kW	2.22/1.67/1.2	3.04/2.58/1.87	3.71/3.17/2.62
	Water flow rate(H/M/L)		m ³ /h	0.4/0.3/0.22	0.55/0.46/0.34	0.67/0.57/0.47
	Water pressure drop(H/M/L)		kPa	5/5/5	10/5.4/3	15/9/8
Heating	Capacity (H/M/L)		kW	2.81/2.23/1.54	3.58/3.09/2.35	4.56/3.89/3.08
	Water flow rate(H/M/L)		m ³ /h	0.51/0.41/0.28	0.65/0.56/0.43	0.83/0.71/0.56
	Water pressure drop(H/M/L)		kPa	5/3.5/5	10/5.5/3.5	15/9.5/8
Power input (H/M/L)		W	92/50/43	76/62/52	90/78/68	
Current Input	H	A	0.22	0.28	0.35	
Sound pressure level	H/M/L	dB(A)	37/33/27	38/34/28	38/35/29	
Fan motor	Type		Low noise 4-speed fan motor			
	Quantity		1	1	1	
Fan	Type		Centrifugal, forward-curved Blades			
	Quantity		1	2	2	
Coil	Row		4	4	4	
	Max. Working pressure		MPa	1.6	1.6	1.6
	Diameter		mm	Φ9.52	Φ9.52	Φ9.52
Body	Dimensions	W×H×D	mm	741×241×522	841×241×522	941×241×522
	Net weight		kg	15.3	17.5	20.7
	Packing	W×H×D	mm	790×260×550	890×260×550	990×260×550
	Gross weight		kg	17.6	20	23.1
Pipe connection	Water inlet/outlet pipe		inch	RC3/4	RC3/4	RC3/4
	Drain pipe		inch	R3/4	R3/4	R3/4

Note:

1. H: high fan speed; M: medium fan speed; L: low fan speed
2. The data is based on 0Pa external static pressure.
3. Cooling conditions: entering water 7°C, temperature rise 5°C, entering air temperature 27°C DB, 19°C WB.
4. Heating conditions: entering water 45°C, leaving water 40°C, Entering air temperature 20°C DB.
5. Noise is tested in semi-anechoic test room.

4-row Duct

Model MDVF-			500D304E	600D304E	800D304E	
Power supply		V/Ph/Hz	220-240/1/50			
Air flow (H/M/L)		m ³ /h	948/766/578	1124/875/682	1447/1119/857	
		CFM	557/451/340	661/515/401	851/658/504	
Standard external static pressure		Pa	30	30	30	
Cooling	Capacity (H/M/L)		kW	4.49/3.87/3.07	6.18/4.95/3.78	6.31/5.1/4.14
	Water flow rate(H/M/L)		m ³ /h	0.81/0.7/0.55	1.11/0.89/0.68	1.14/0.92/0.75
	Water pressure drop(H/M/L)		kPa	20/16/15	30/22/16	15/7.5/5
Heating	Capacity (H/M/L)		kW	5.44/4.66/3.58	6.94/5.75/4.58	7.78/6.4/4.9
	Water flow rate(H/M/L)		m ³ /h	0.99/0.85/0.65	1.26/1.04/0.83	1.41/1.16/0.89
	Water pressure drop(H/M/L)		kPa	22.6/20/15	28/20/15	15/10/6
Power input (H/M/L)		W	110/90/77	142/124/109	166/134/113	
Current Input	H	A	0.43	0.5	0.67	
Sound pressure level	H/M/L	dB(A)	40/35/30	41/36/31	42/37/32	
Fan motor	Type		Low noise 4-speed fan motor			
	Quantity		1	1	2	
Fan	Type		Centrifugal, forward-curved Blades			
	Quantity		2	2	4	
Coil	Row		4	4	4	
	Max. Working pressure		MPa	1.6	1.6	1.6
	Diameter		mm	Φ9.52	Φ9.52	Φ9.52
Body	Dimensions	W×H×D	mm	941×241×522	1161×241×522	1461×241×522
	Net weight		kg	20.7	23.5	32.9
	Packing	W×H×D	mm	990×260×550	1210×260×550	1510×260×550
	Gross weight		kg	23.1	26.5	36.5
Pipe connection	Water inlet/outlet pipe		inch	RC3/4	RC3/4	RC3/4
	Drain pipe		inch	R3/4	R3/4	R3/4

Note:

1. H: high fan speed; M: medium fan speed; L: low fan speed
2. The data is based on 0Pa external static pressure.
3. Cooling conditions: entering water 7°C, temperature rise 5°C, entering air temperature 27°C DB, 19°C WB.
4. Heating conditions: entering water 45°C, leaving water 40°C, Entering air temperature 20°C DB.
5. Noise is tested in semi-anechoic test room.

4-row Duct

Model MDVF-			1000D304E	1200D304E	1400D304E	
Power supply		V/Ph/Hz	220-240/1/50			
Air flow (H/M/L)		m ³ /h	1868/1397/1026	2213/1692/1074	2311/1756/1095	
		CFM	1099/822/603	1302/995/632	1359/1033/644	
Standard external static pressure		Pa	30	30	30	
Cooling	Capacity (H/M/L)	kW	7.79/6.13/4.87	10.17/8.57/5.44	11.7/9.43/6.47	
	Water flow rate(H/M/L)	m ³ /h	1.4/1.1/0.88	1.83/1.54/0.98	2.11/1.7/1.16	
	Water pressure drop(H/M/L)	kPa	18.3/12.1/8	33/24.8/11.4	35/23.9/15	
Heating	Capacity (H/M/L)	kW	9.86/7.73/6.01	11.76/10.31/6.76	13.55/10.96/7.12	
	Water flow rate(H/M/L)	m ³ /h	1.79/1.4/1.09	2.14/1.87/1.23	2.46/1.99/1.29	
	Water pressure drop(H/M/L)	kPa	20.6/13.9/8.2	36.1/20.9/13.2	37/26/17	
Power input (H/M/L)		W	223/164/139	277/228/174	325/240/193	
Current Input	H	A	0.78	1	1.2	
Sound pressure level	H/M/L	dB(A)	44/39/33	45/40/34	47/42/36	
Fan motor	Type		Low noise 4-speed fan motor			
	Quantity		2	2	2	
Fan	Type		Centrifugal, forward-curved Blades			
	Quantity		4	4	4	
Coil	Row		4	4	4	
	Max. Working pressure	MPa	1.6	1.6	1.6	
	Diameter		mm	Φ9.52	Φ9.52	Φ9.52
Body	Dimensions	W×H×D	mm	1566×241×522	1856×241×522	2022×241×522
	Net weight		kg	35.4	40.5	44.1
	Packing	W×H×D	mm	1615×260×550	1905×260×550	2070×260×550
	Gross weight		kg	39.1	44	49.4
Pipe connection	Water inlet/outlet pipe		inch	RC3/4	RC3/4	RC3/4
	Drain pipe		inch	R3/4	R3/4	R3/4

Note:

1. H: high fan speed; M: medium fan speed; L: low fan speed
2. The data is based on 0Pa external static pressure.
3. Cooling conditions: entering water 7°C, temperature rise 5°C, entering air temperature 27°C DB, 19°C WB.
4. Heating conditions: entering water 45°C, leaving water 40°C, Entering air temperature 20°C DB.
5. Noise is tested in semi-anechoic test room.

7. Dimension

2-Row Duct and 4-Row Duct Two pipe type (unit: mm)

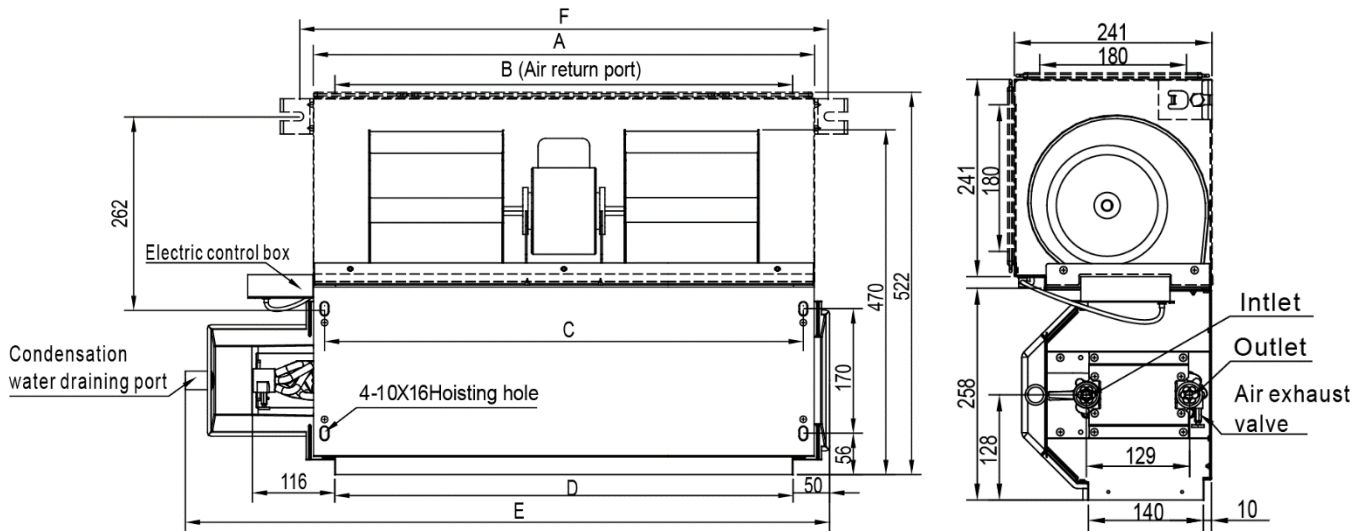

3-Row Duct Two pipe type (unit: mm)

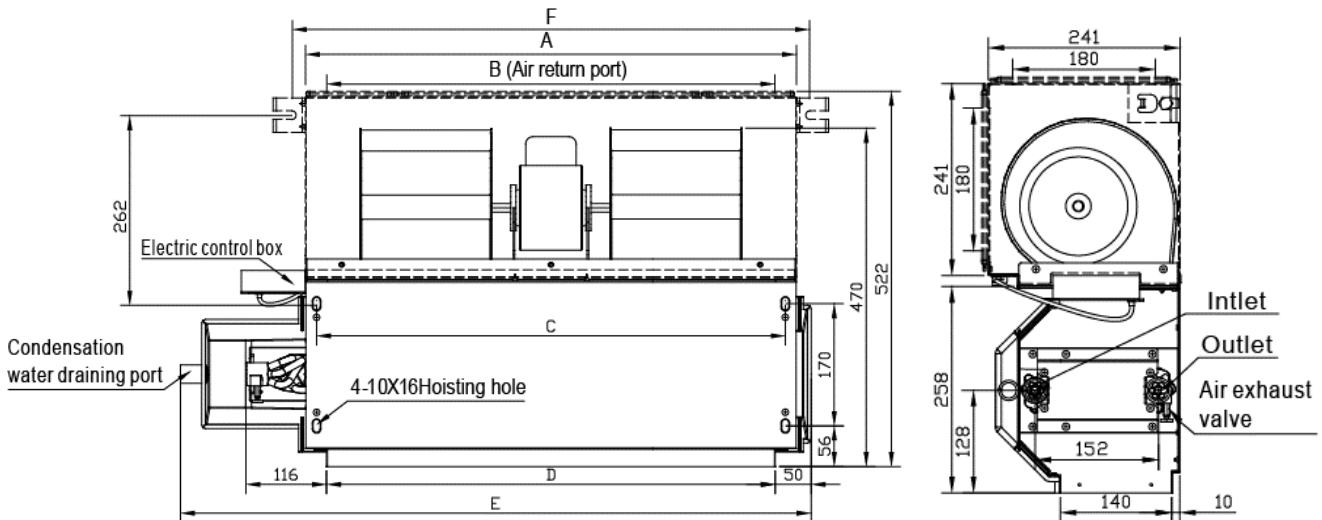

Model Size	200	300	400 500	600	800	1000	1200	1400
A	545	645	745	965	1265	1370	1660	1826
B	484	585	685	905	1205	1310	1600	1766
C	513	613	713	933	1233	1338	1628	1794
D	485	585	685	905	1205	1310	1600	1766
E	741	841	941	1161	1461	1566	1856	2022
F	583	683	783	1003	1303	1408	1698	1864

Notes:

- The above figure is only an instance, which would be different from the one that you purchase.
- The dotted line in the figure is the dimension for air return plenum.
- Units with air return plenum is standard; units without air return plenum can be customized.

8. Sound Levels

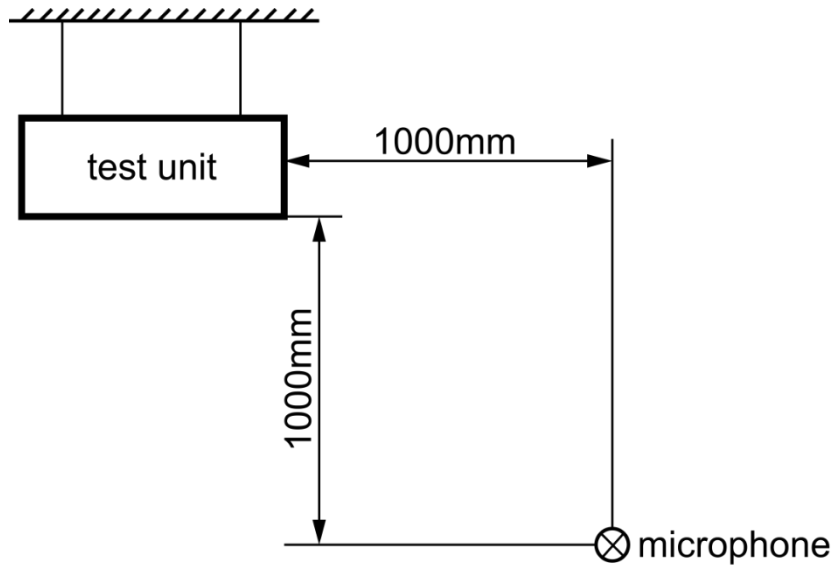

MDVF-200D302E

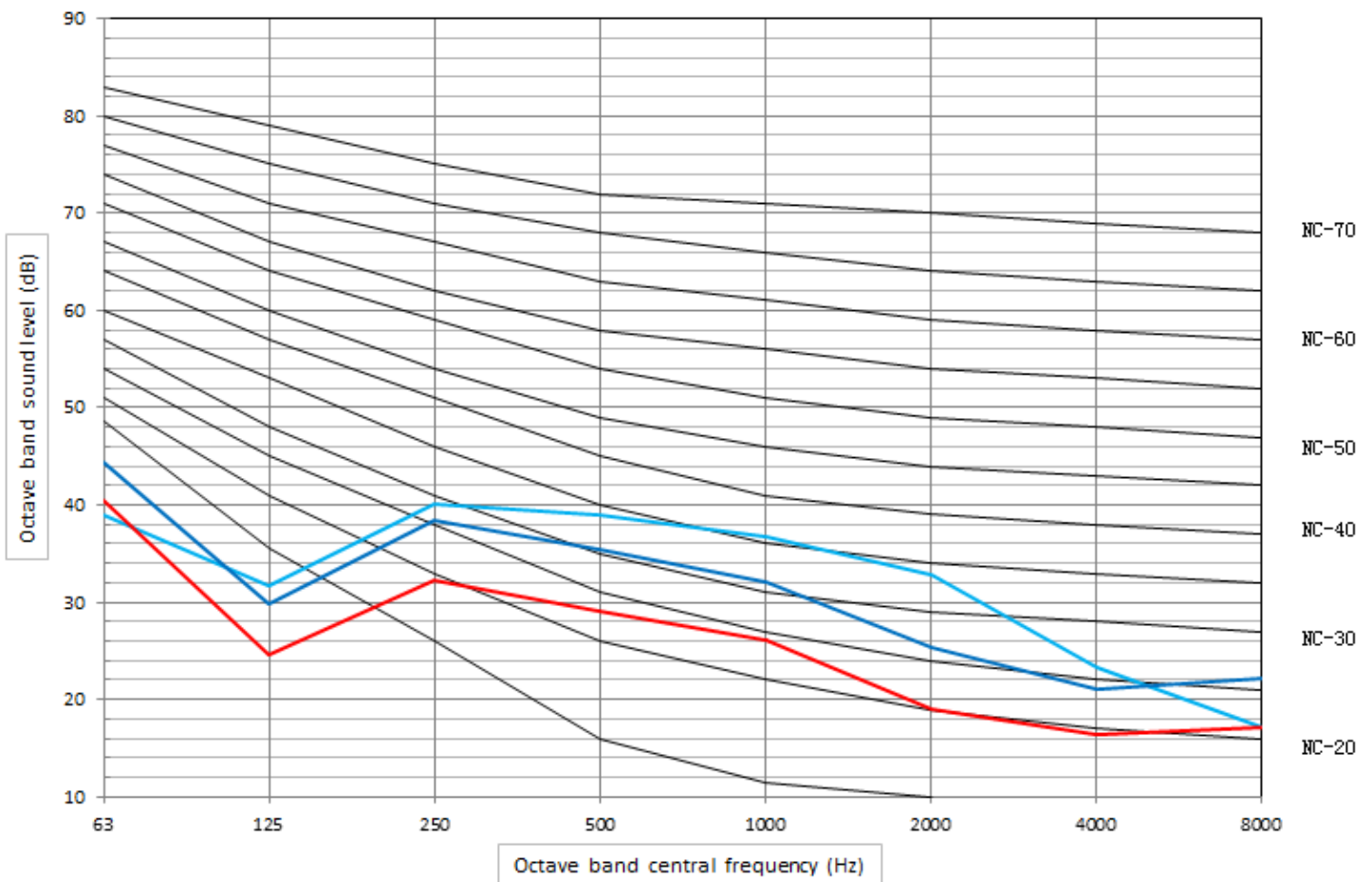

MDVF-300D302E

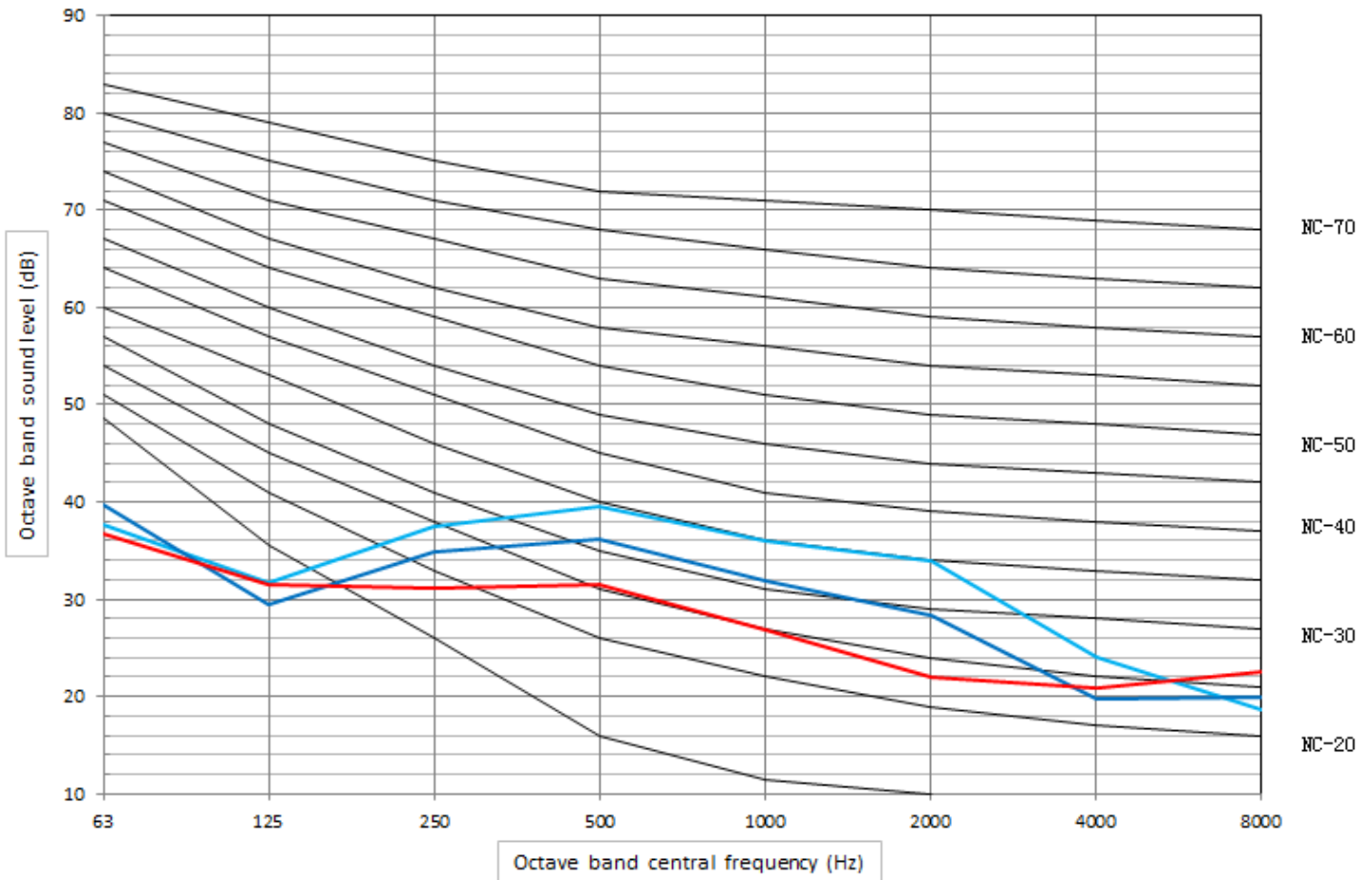

MDVF-400D302E

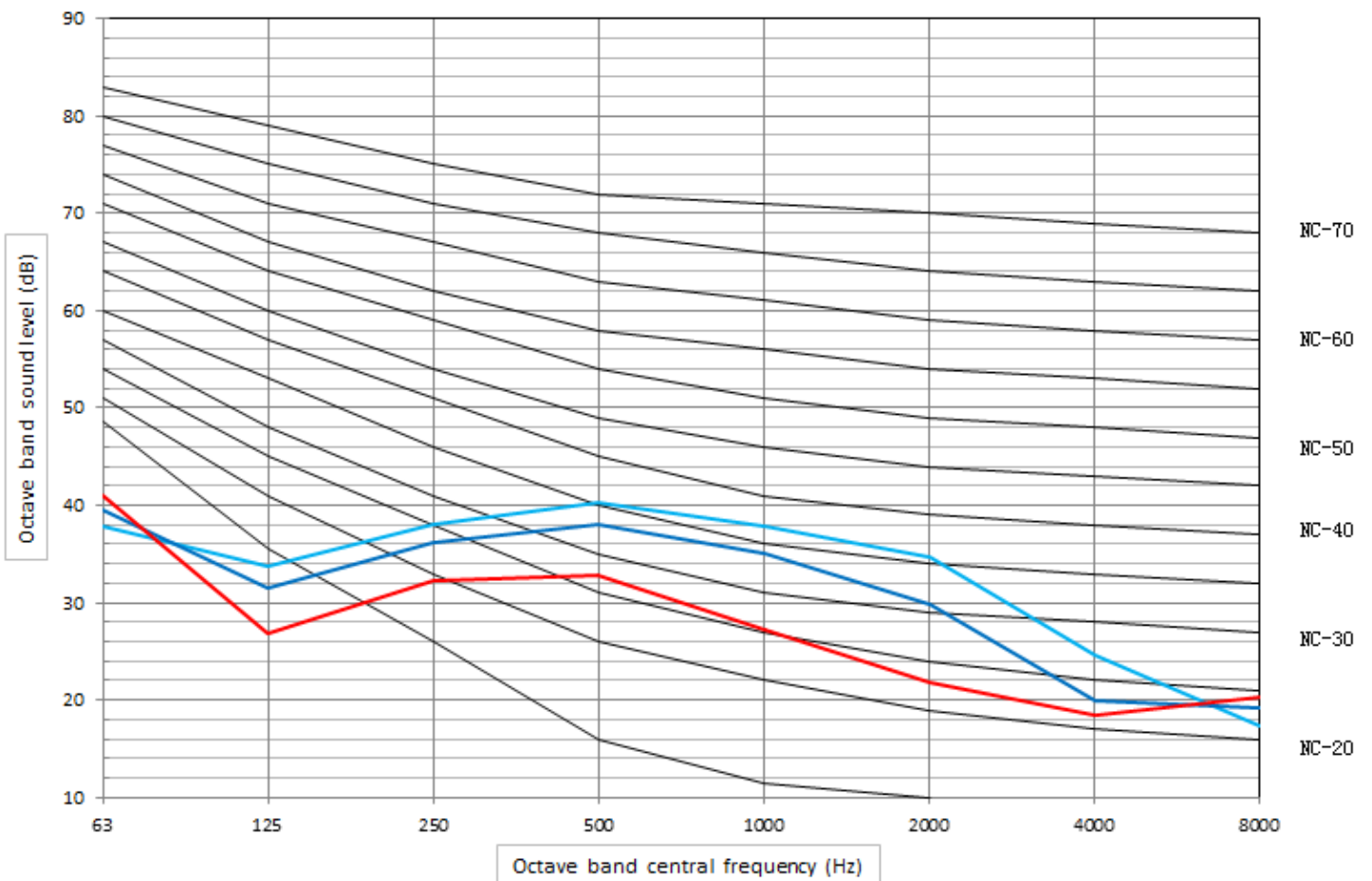

MDVF-500D302E

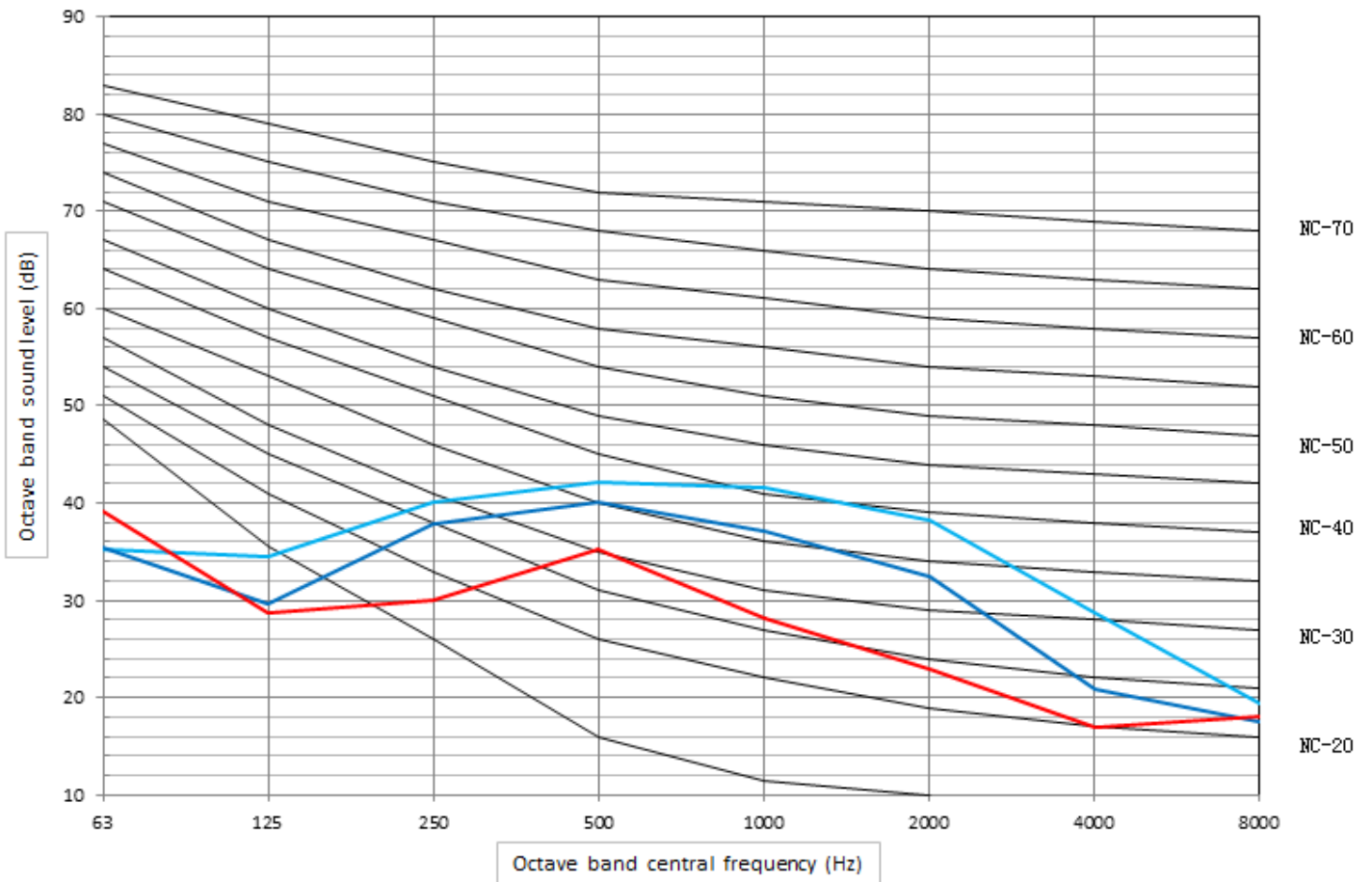

MDVF-600D302E

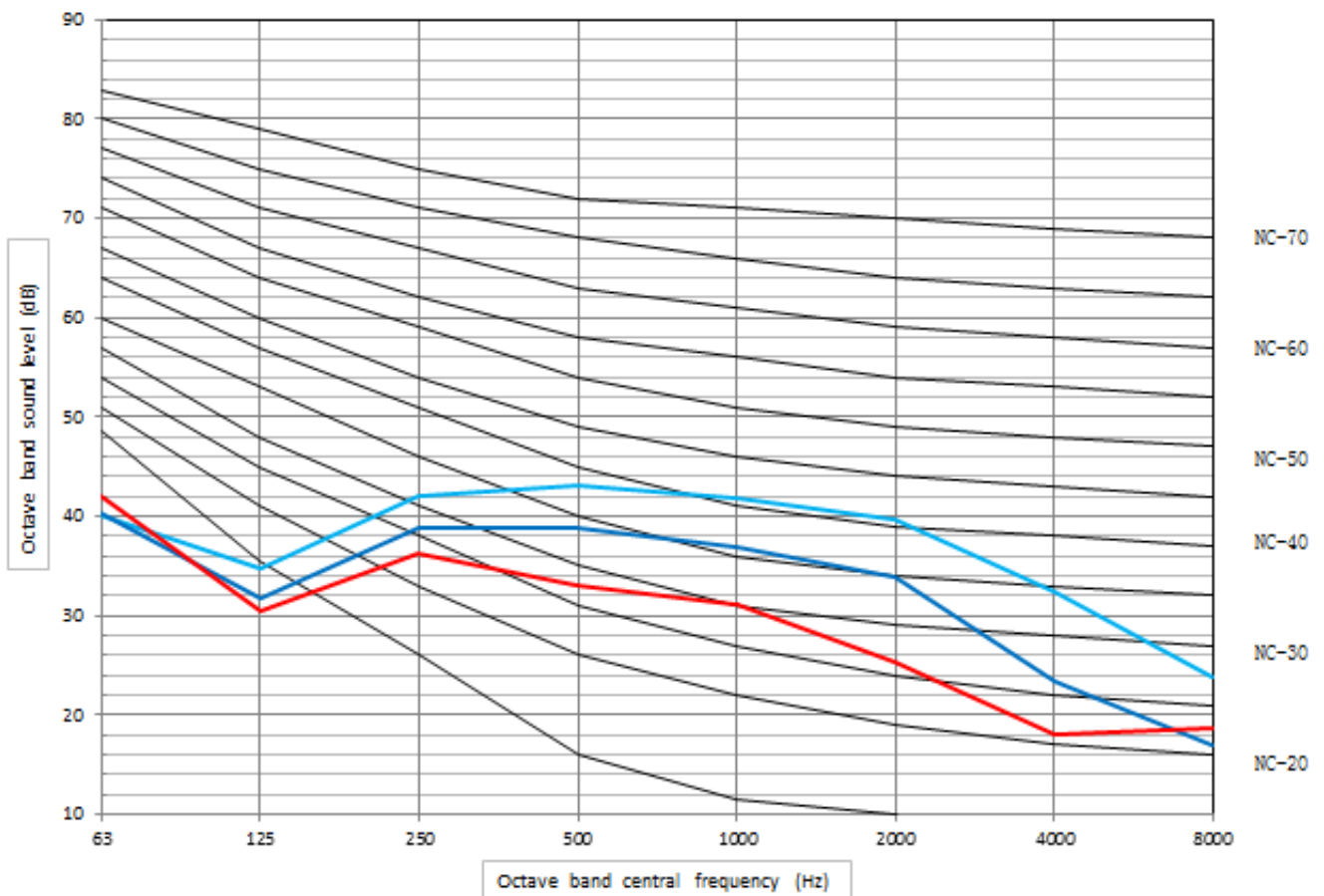

MDVF-800D302E

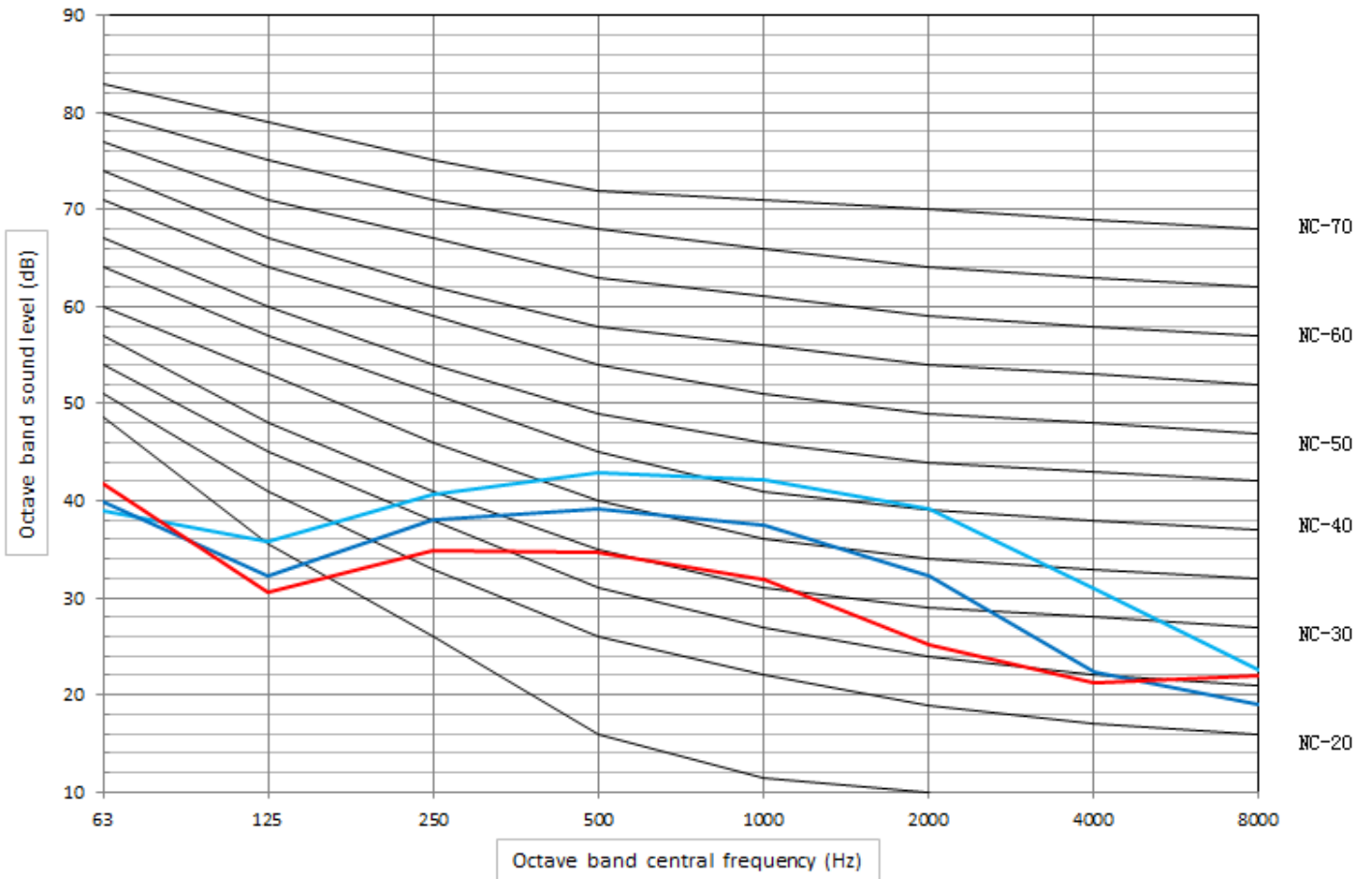

MDVF-1000D302E

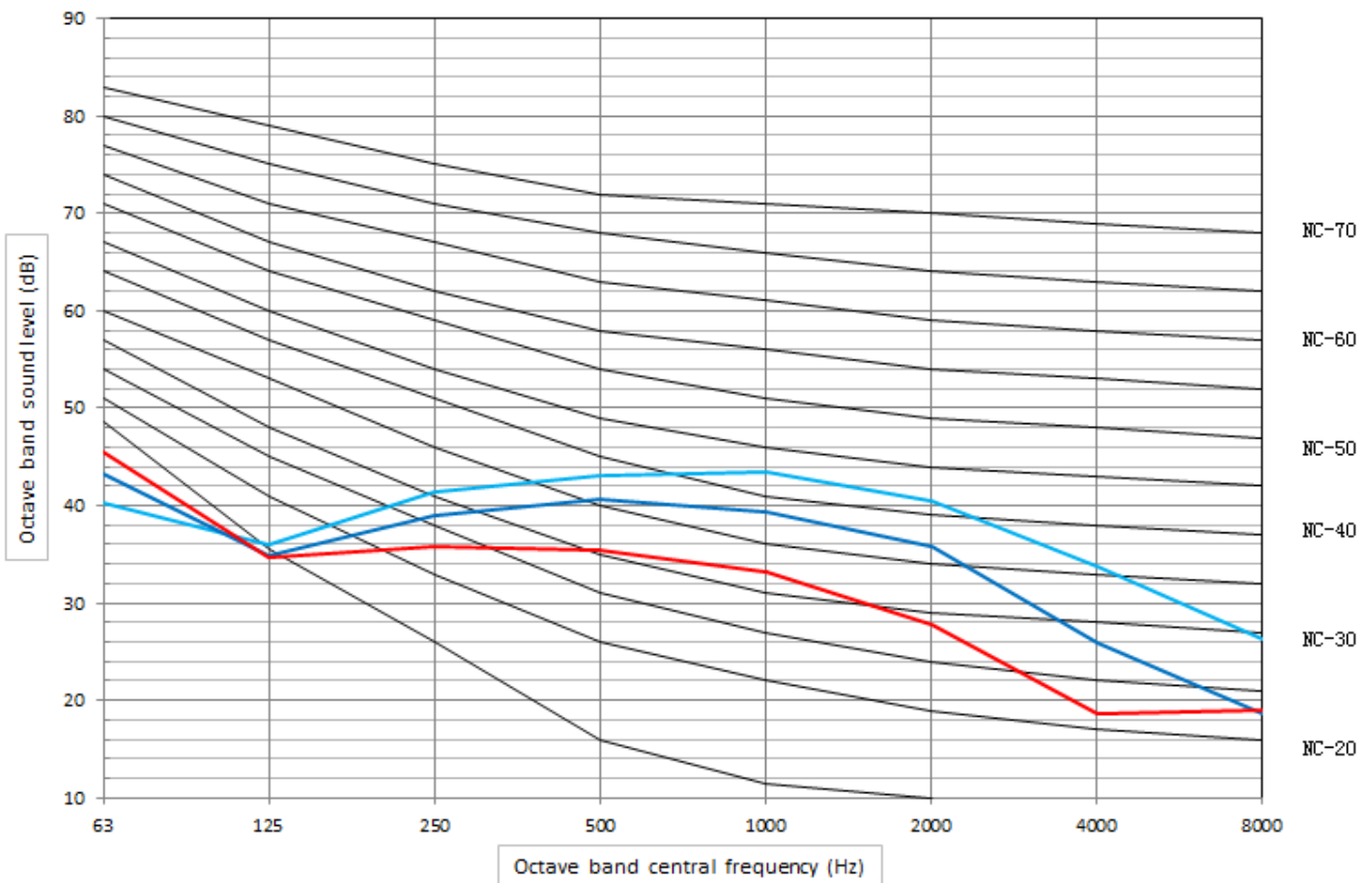

MDVF-1200D302E

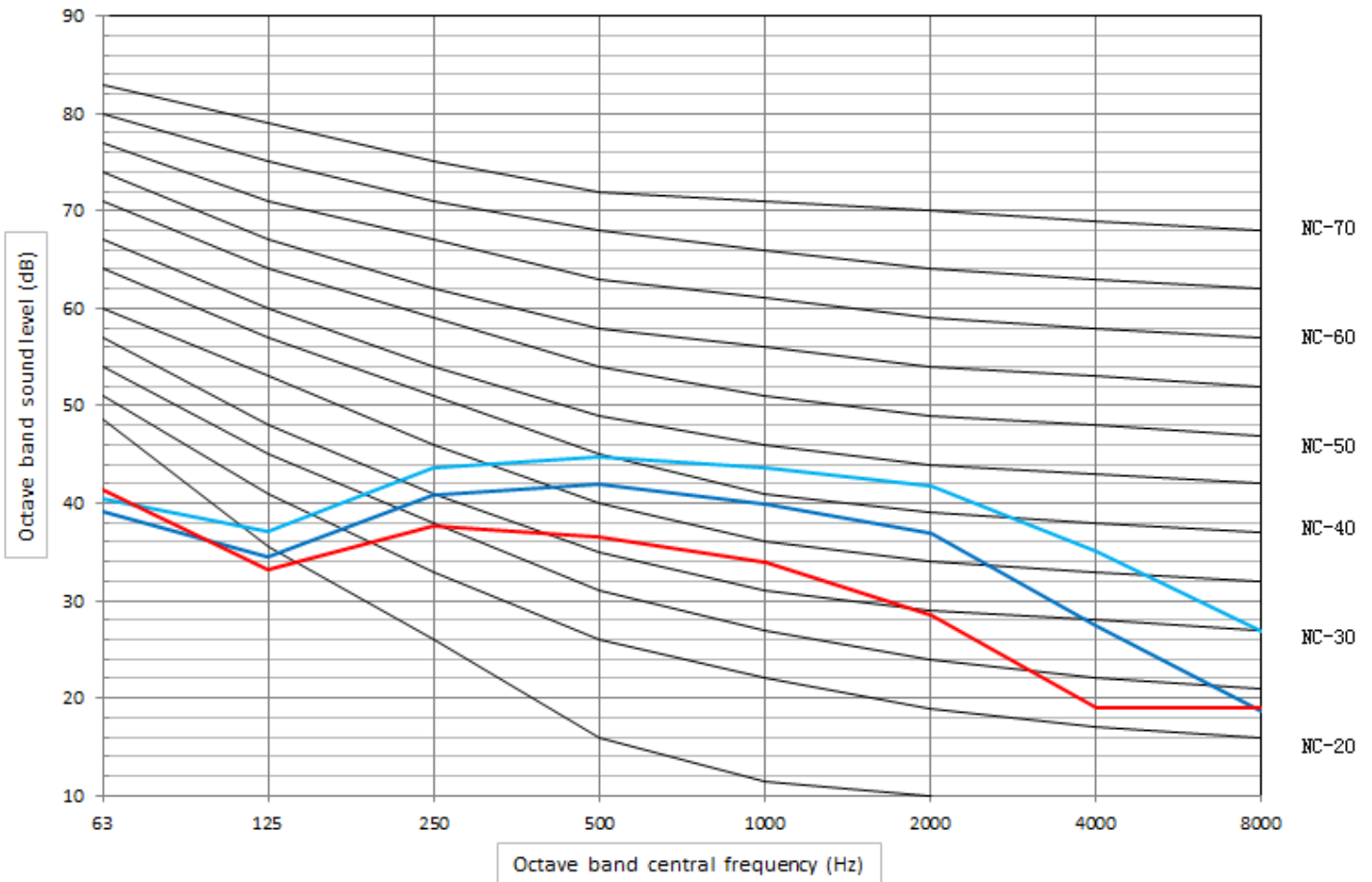

MDVF-1400D302E

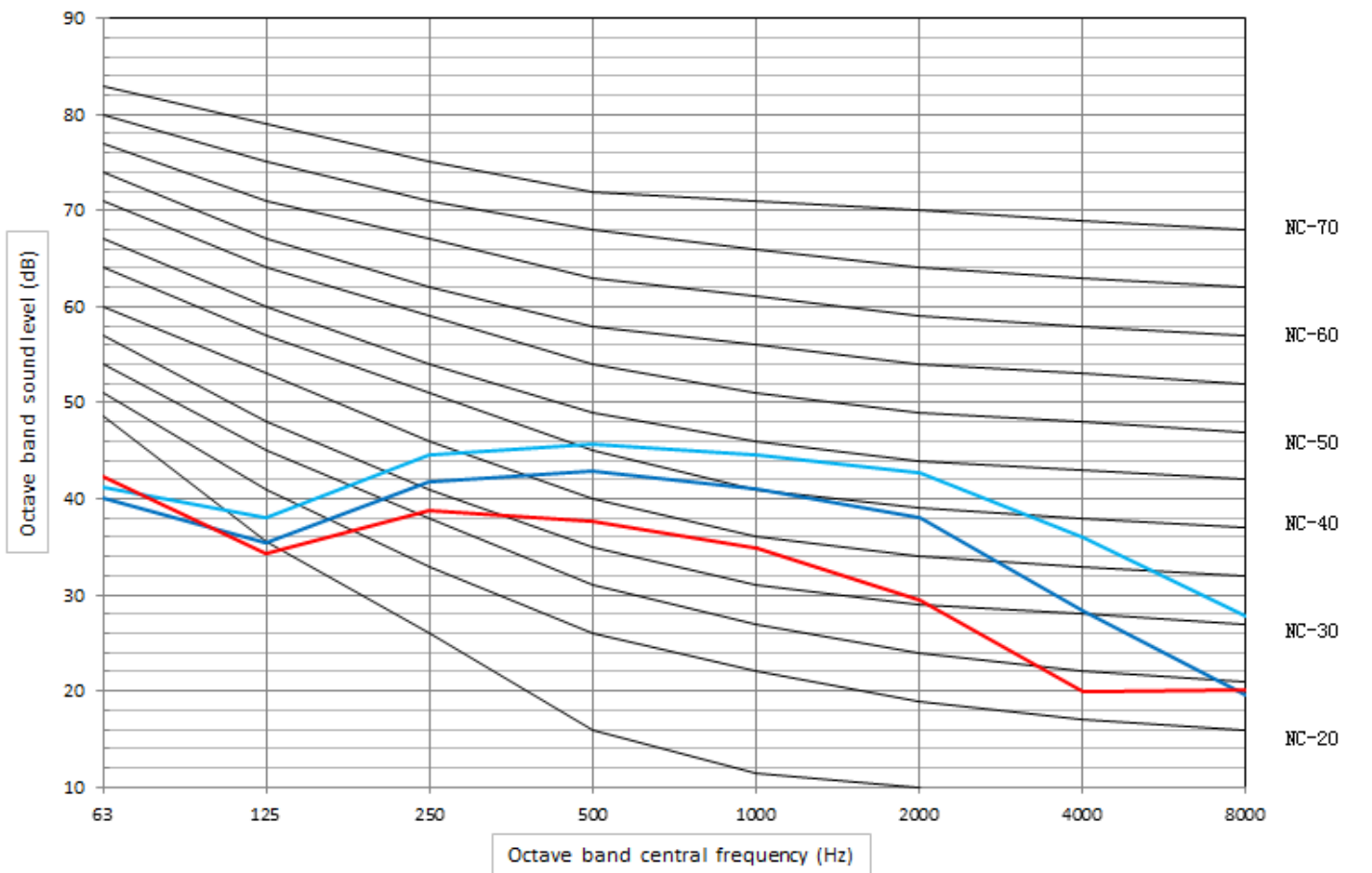

MDVF-200D3E

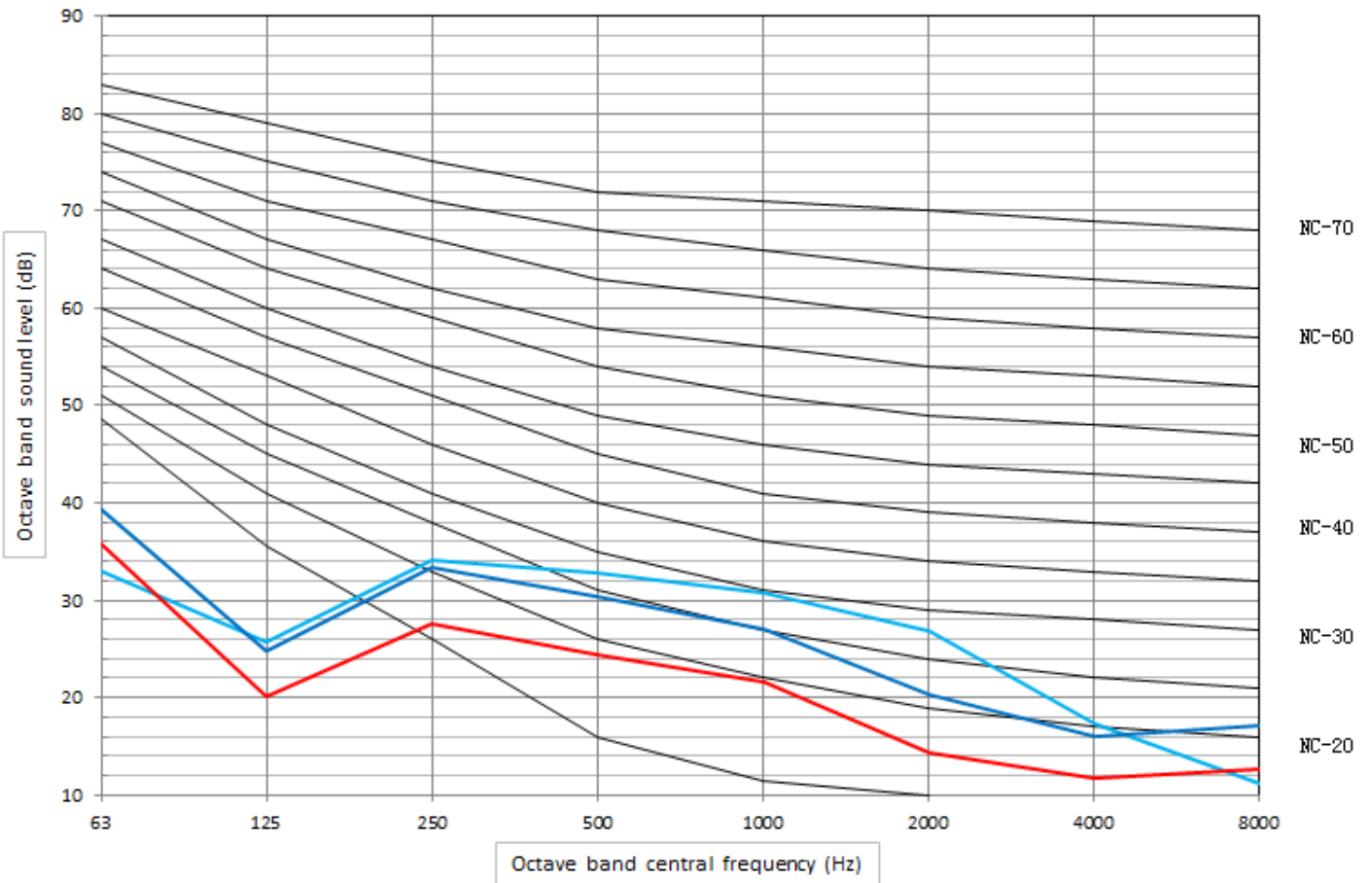

MDVF-300D3E

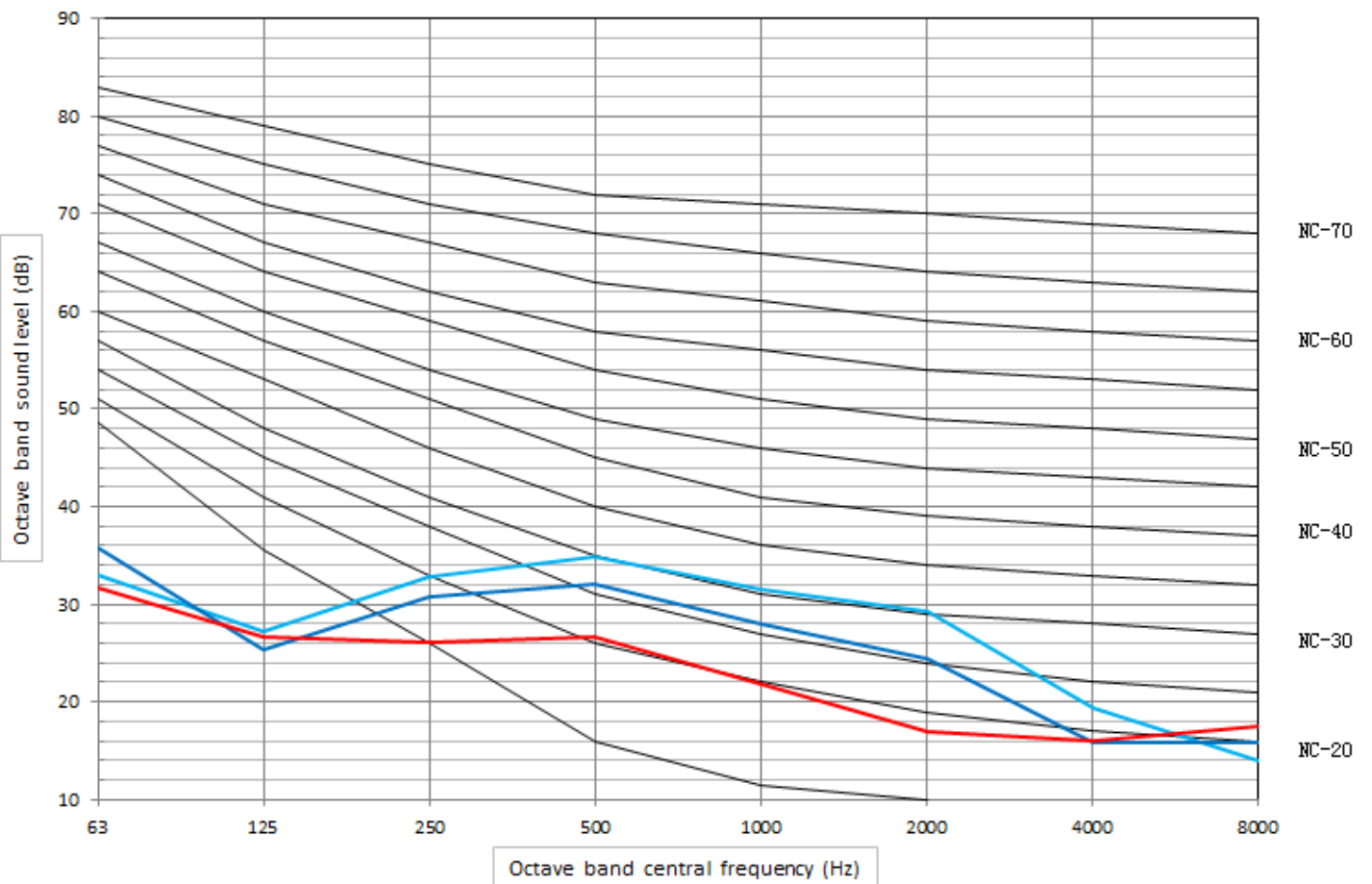

MDVF-400D3E

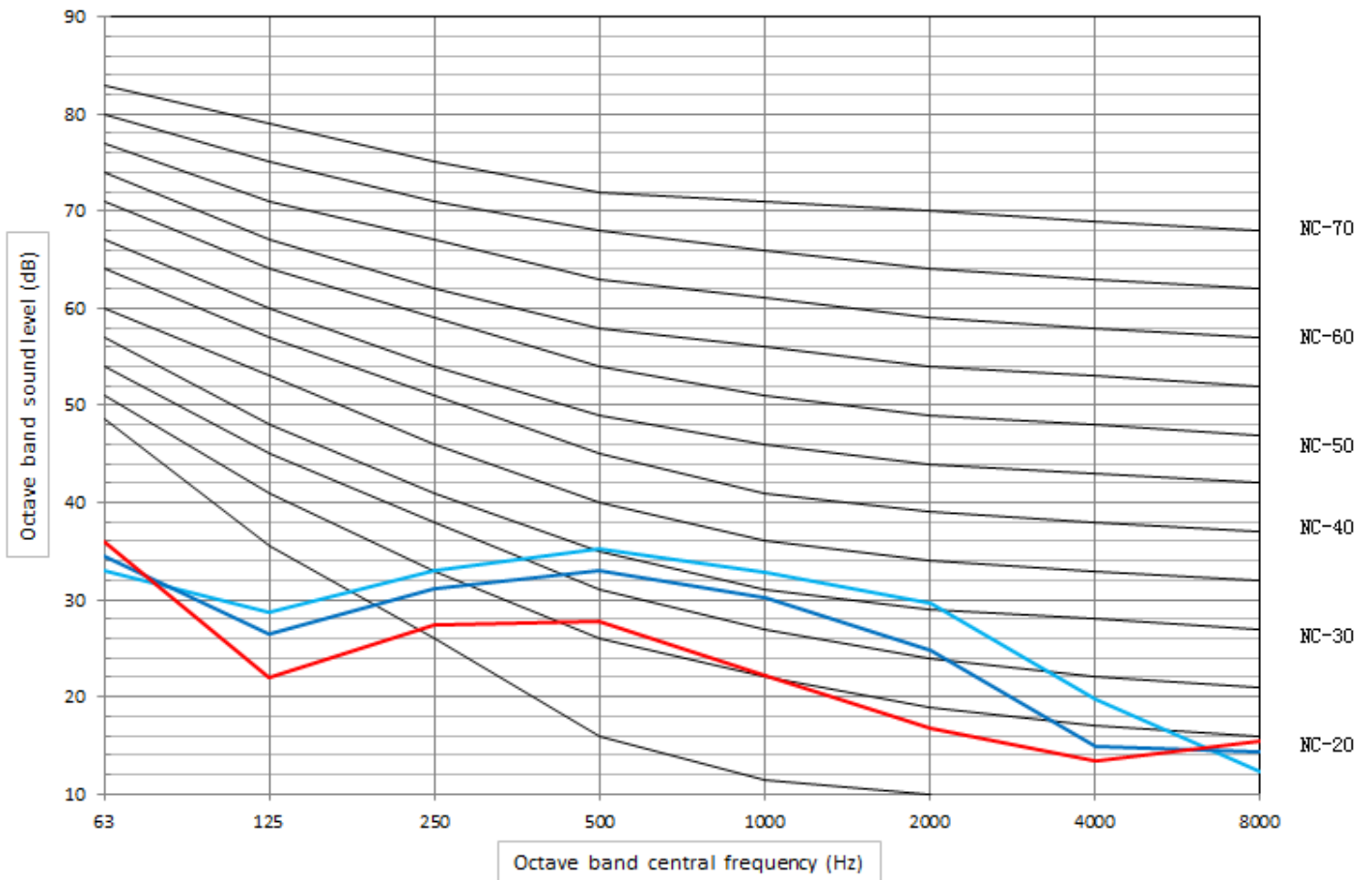

MDVF-500D3E

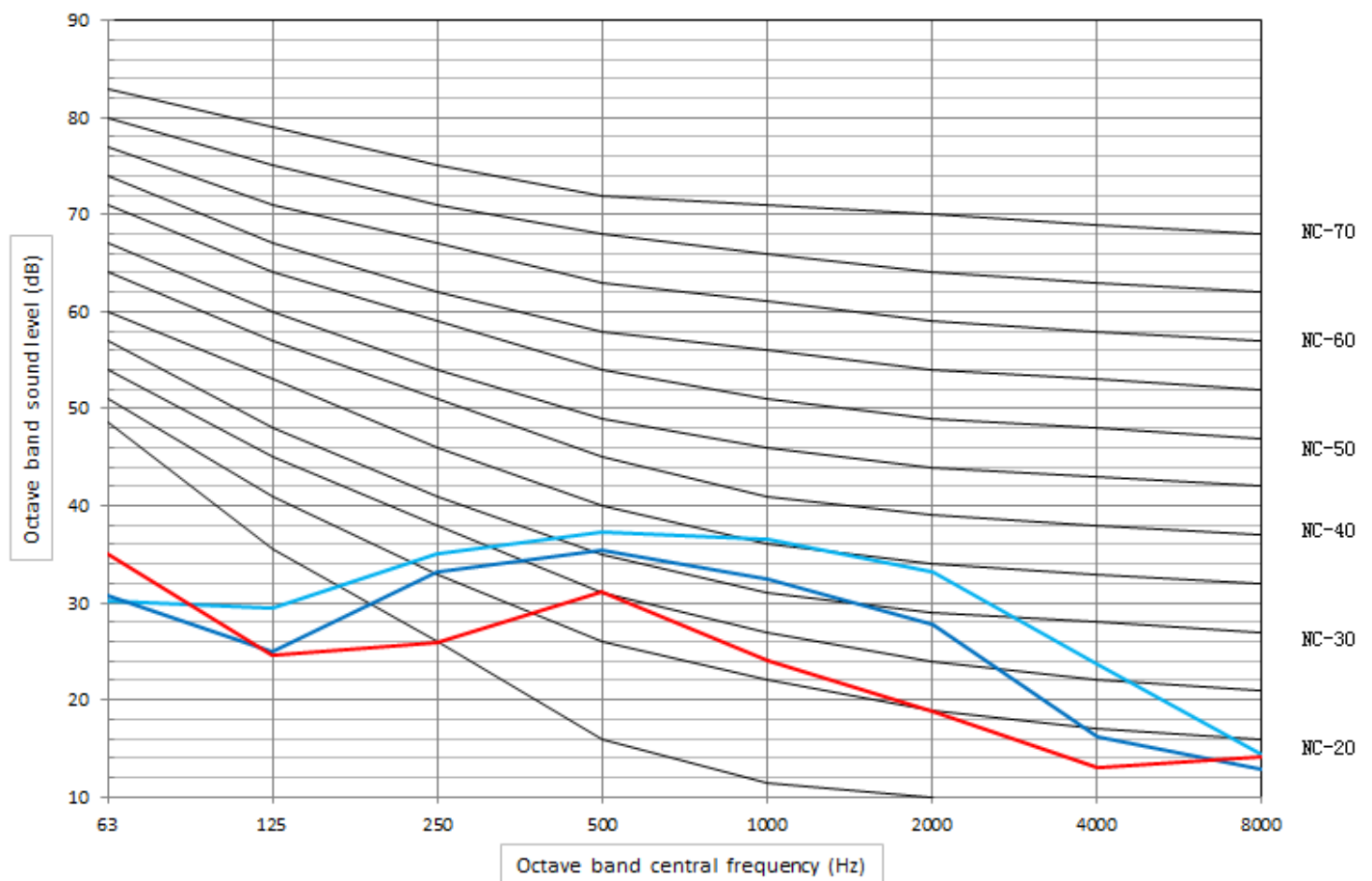

MDVF-600D3E

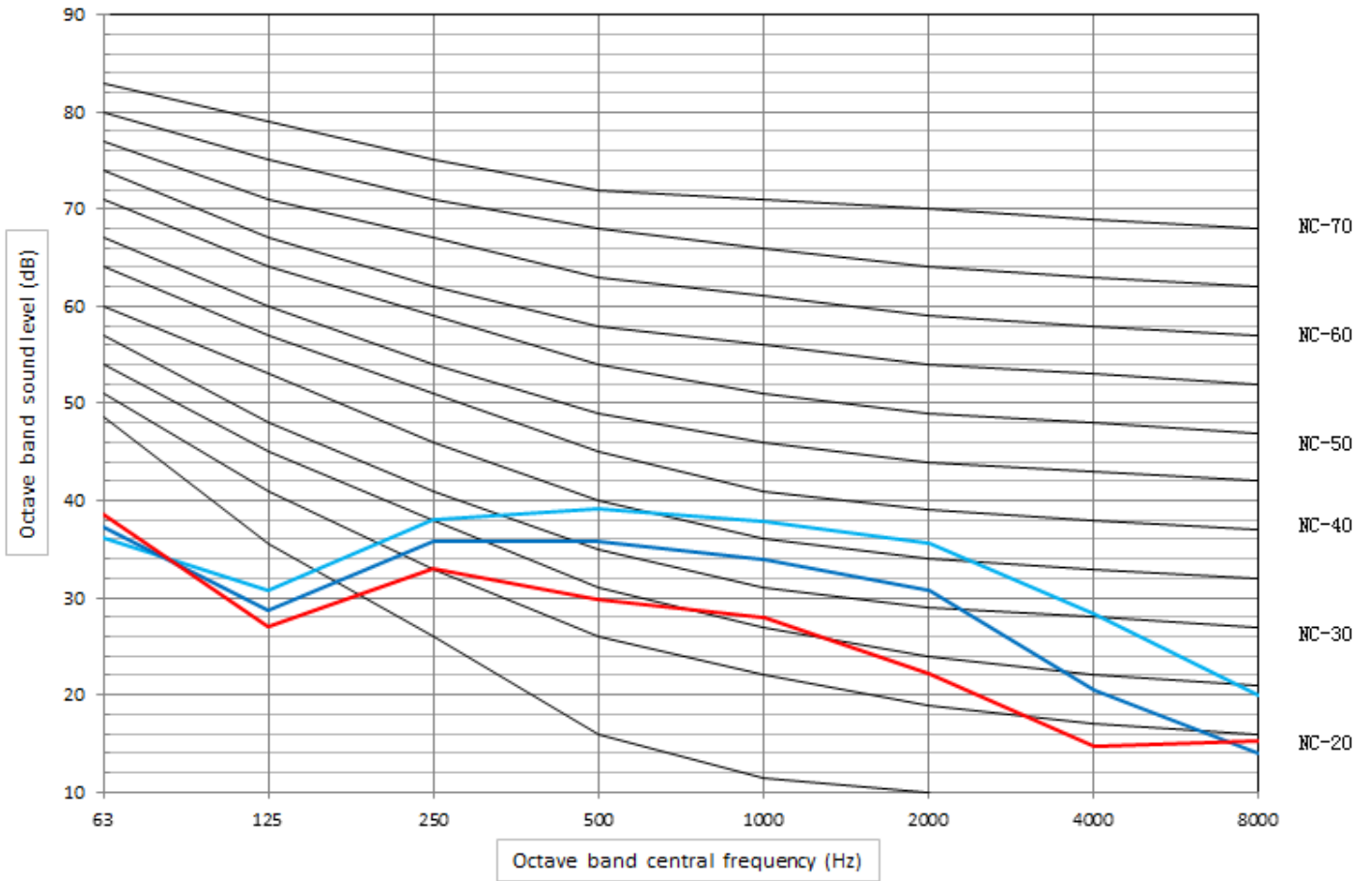

MDVF-800D3E

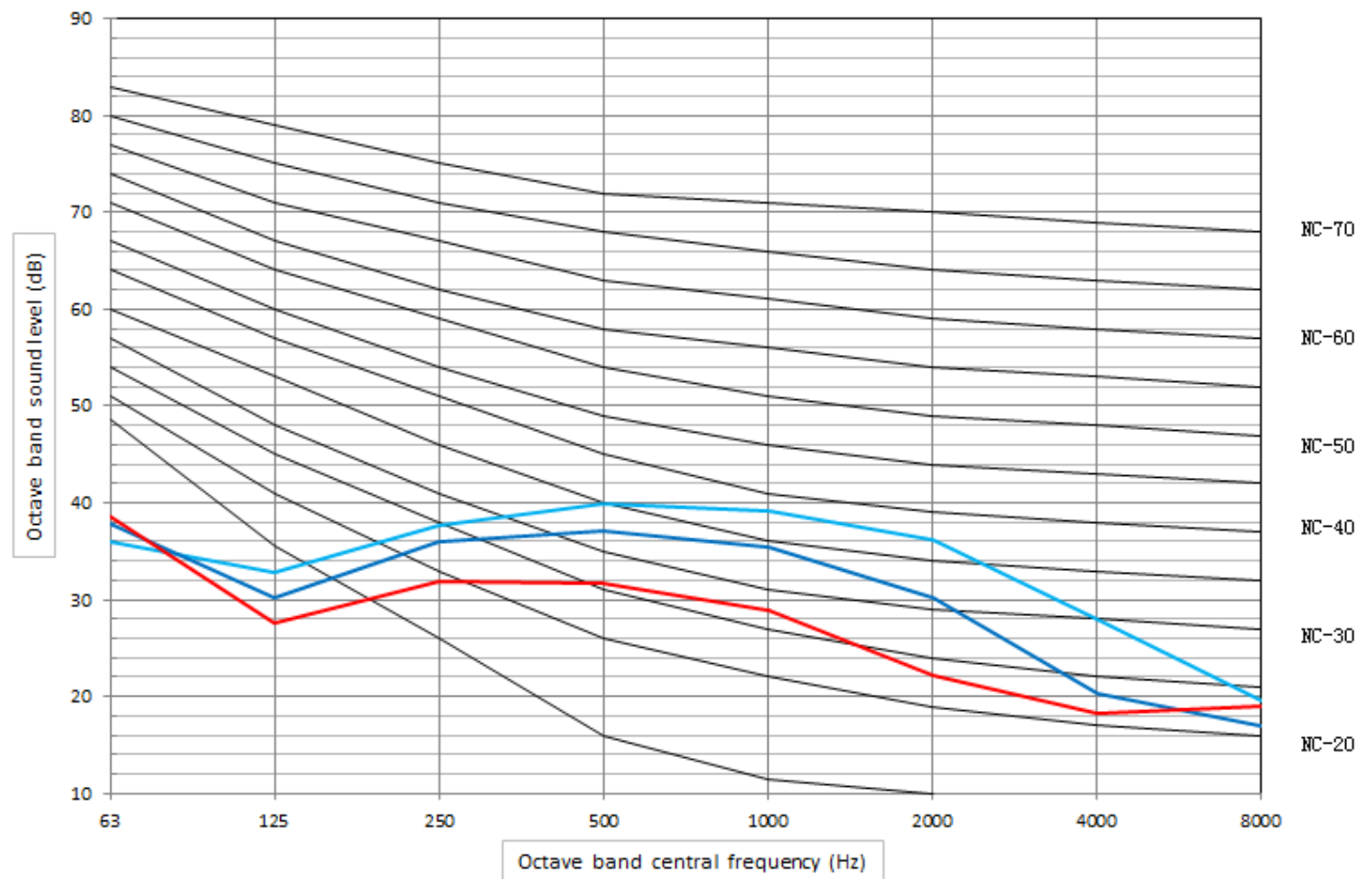

MDVF-1000D3E

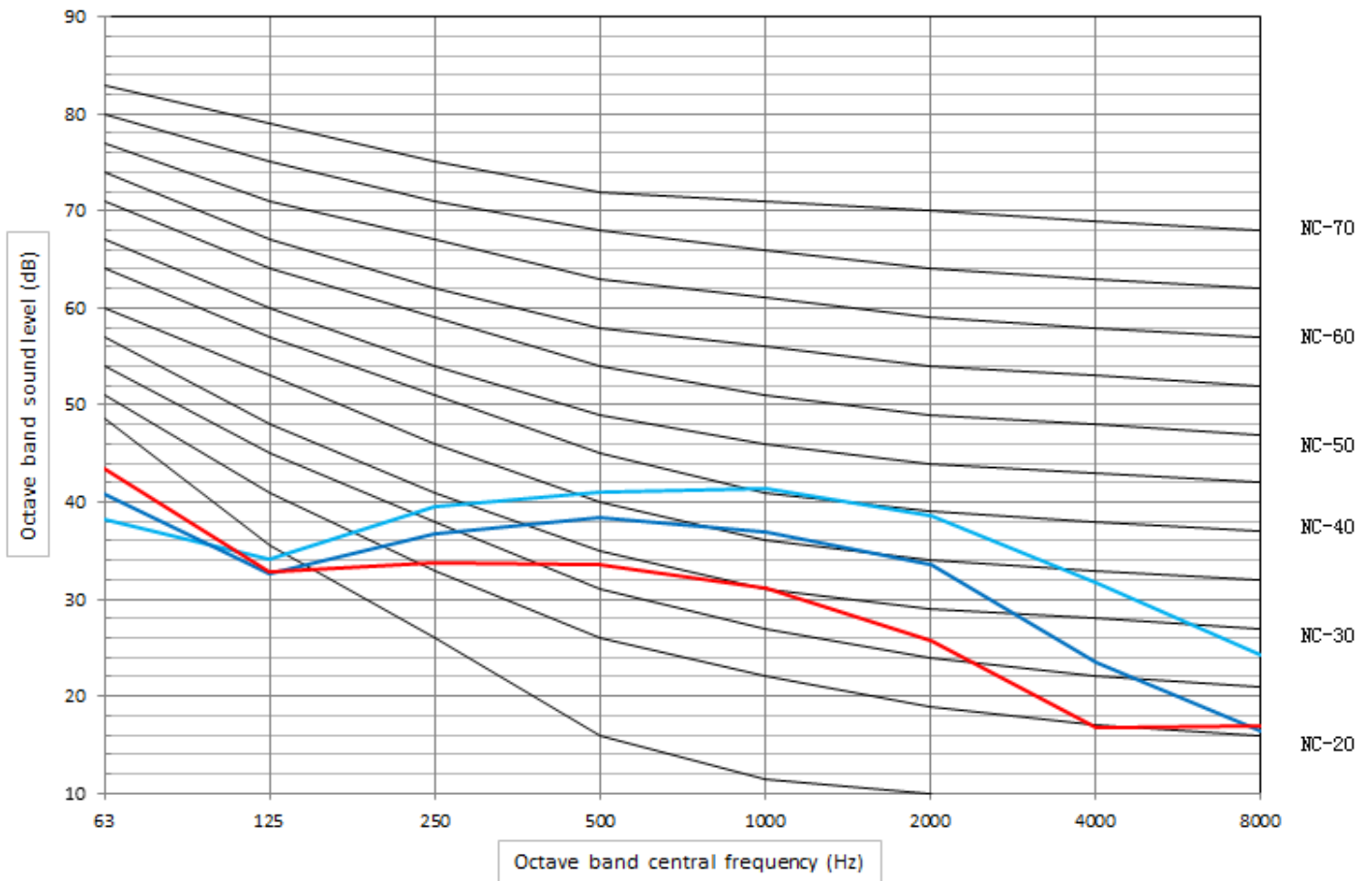

MDVF-1200D3E

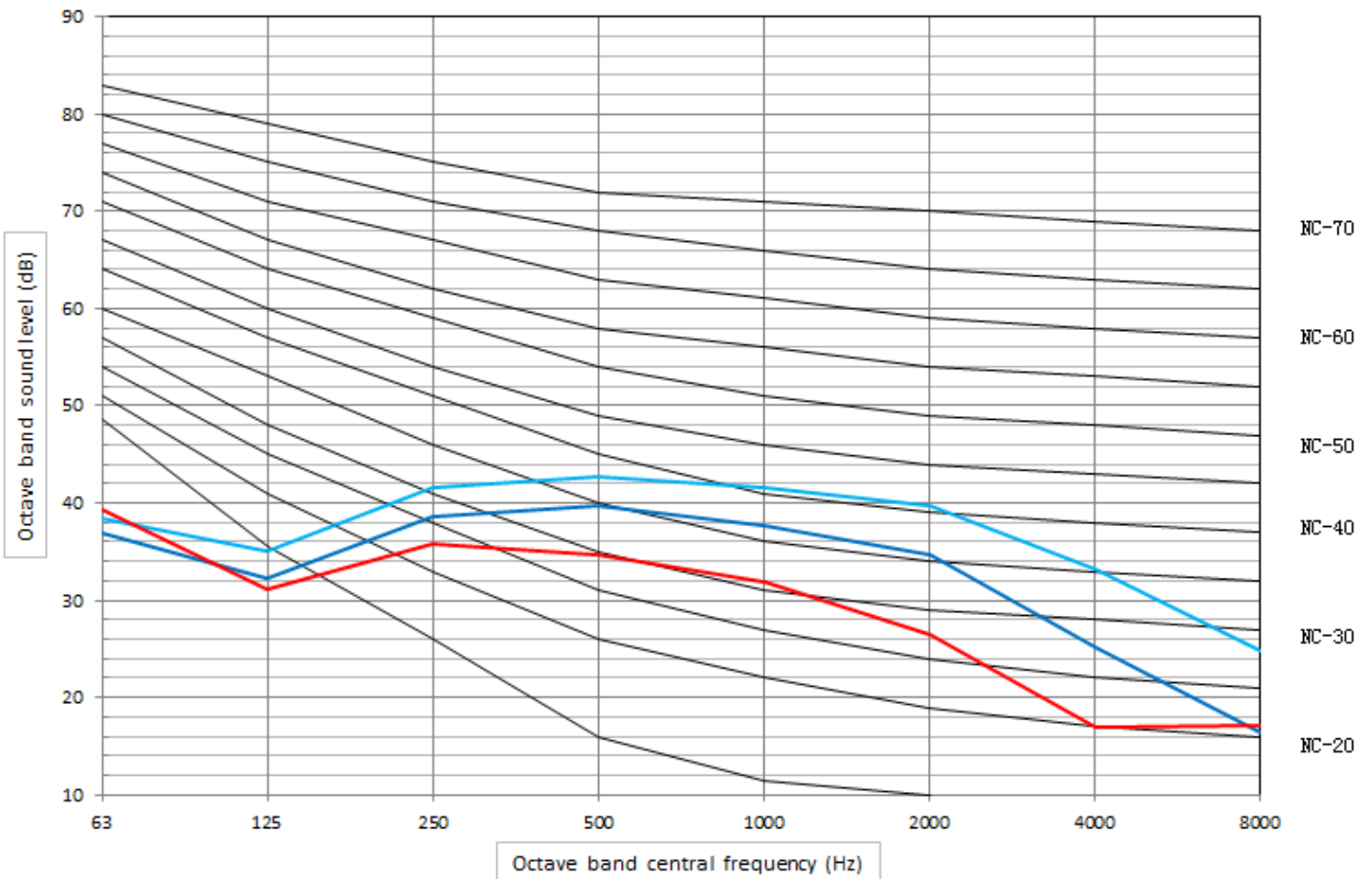

MDVF-1400D3E

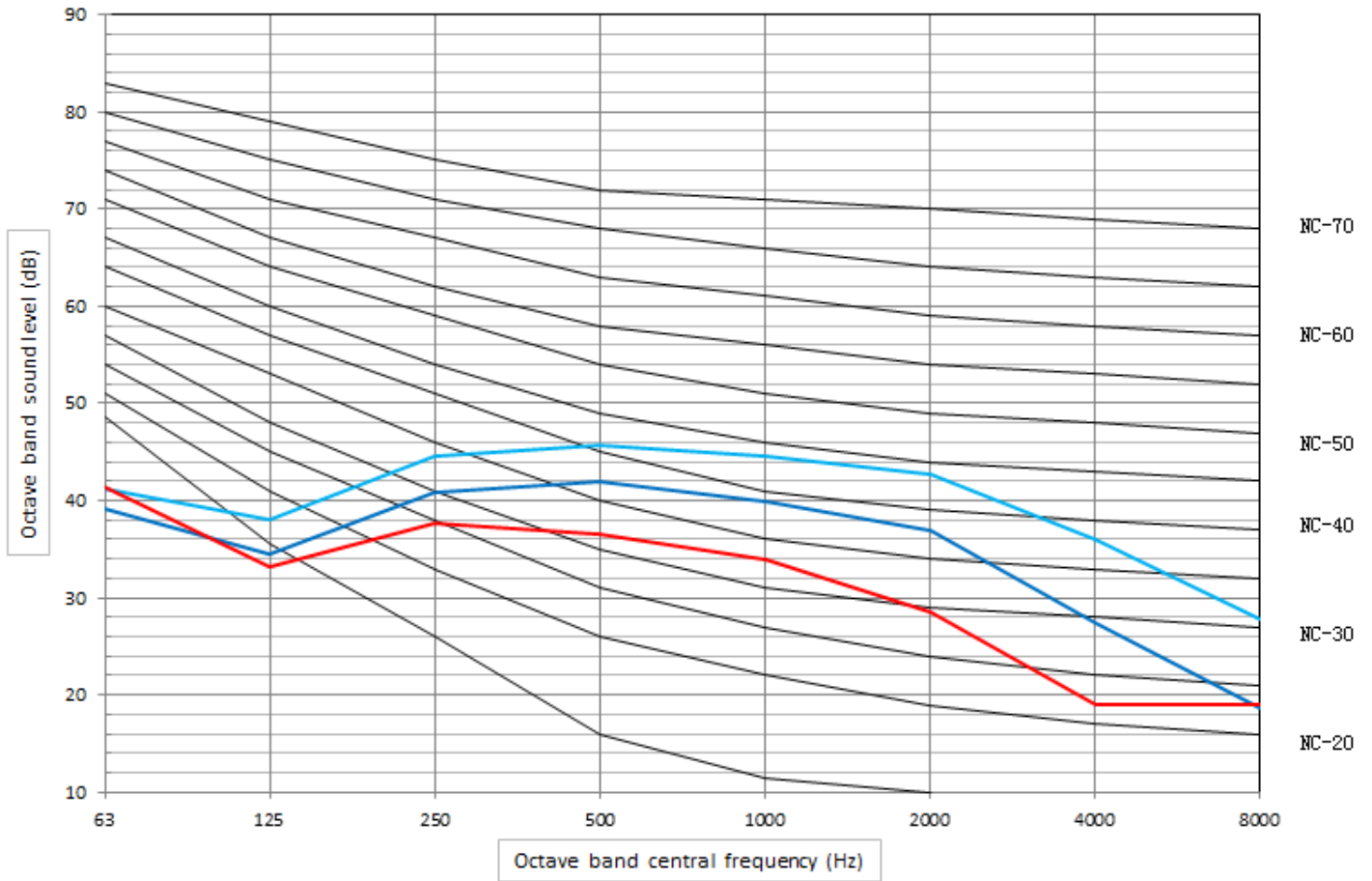

MDVF-200D303E

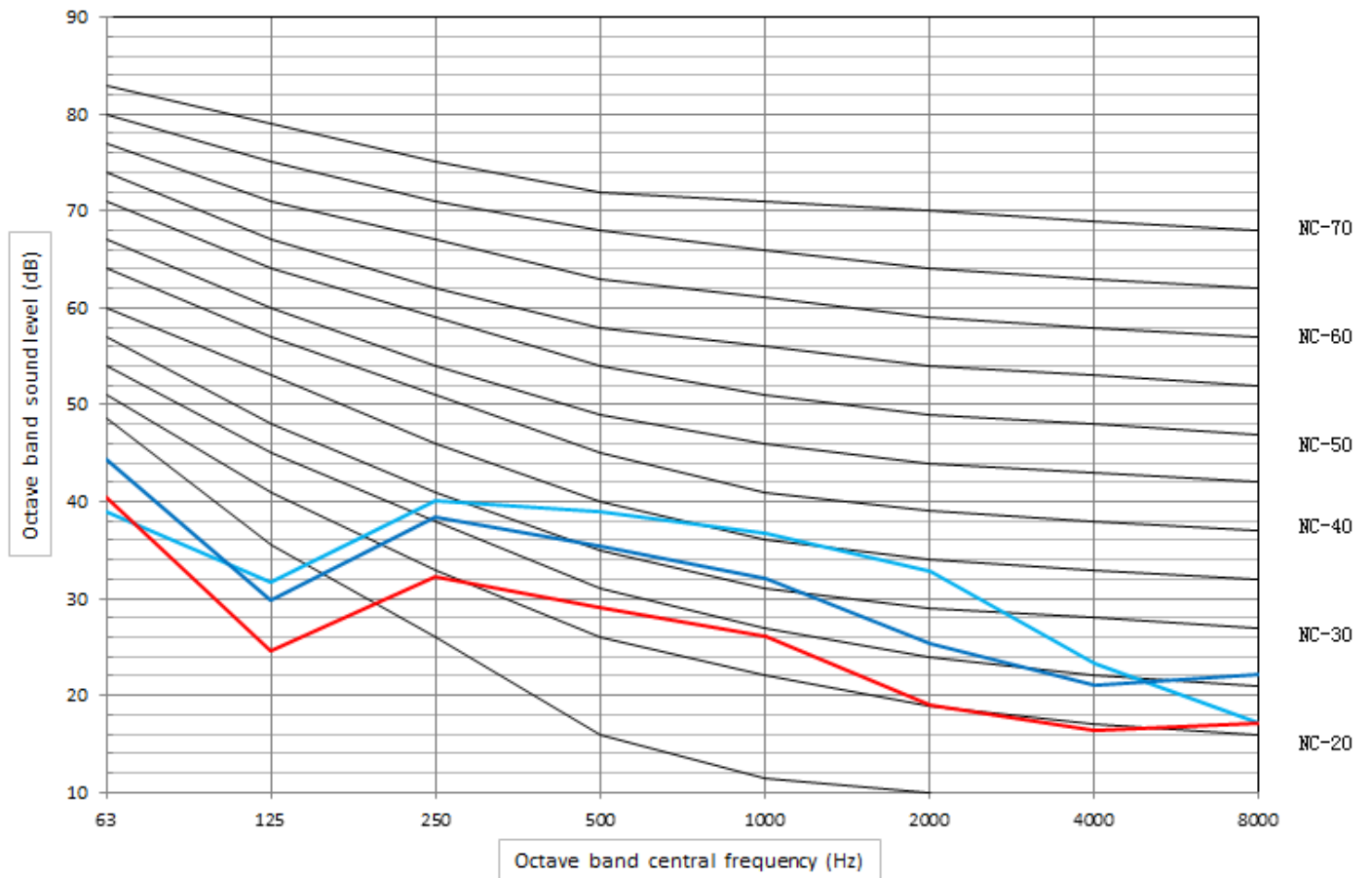

MDVF-300D303E

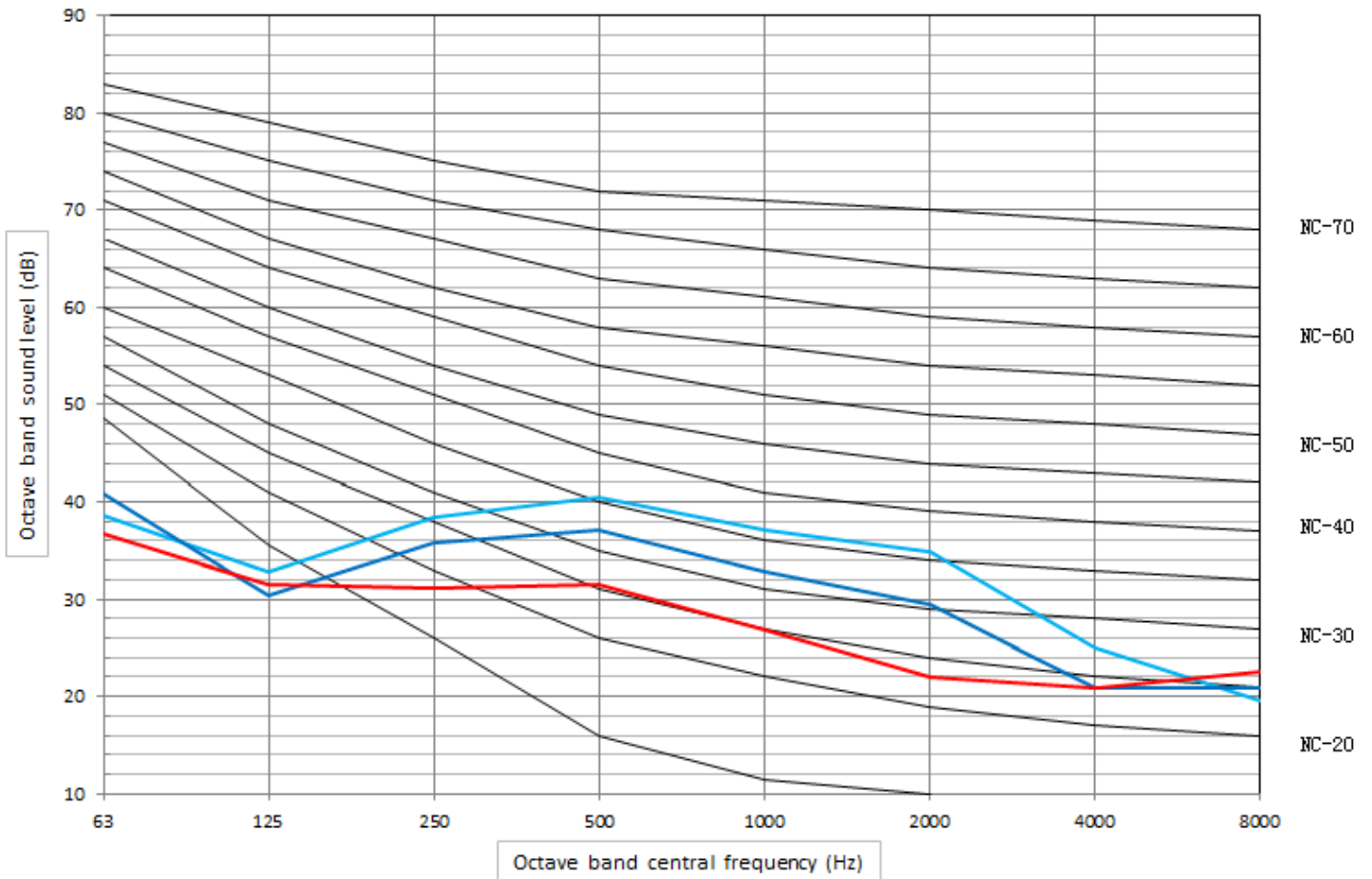

MDVF-400D303E

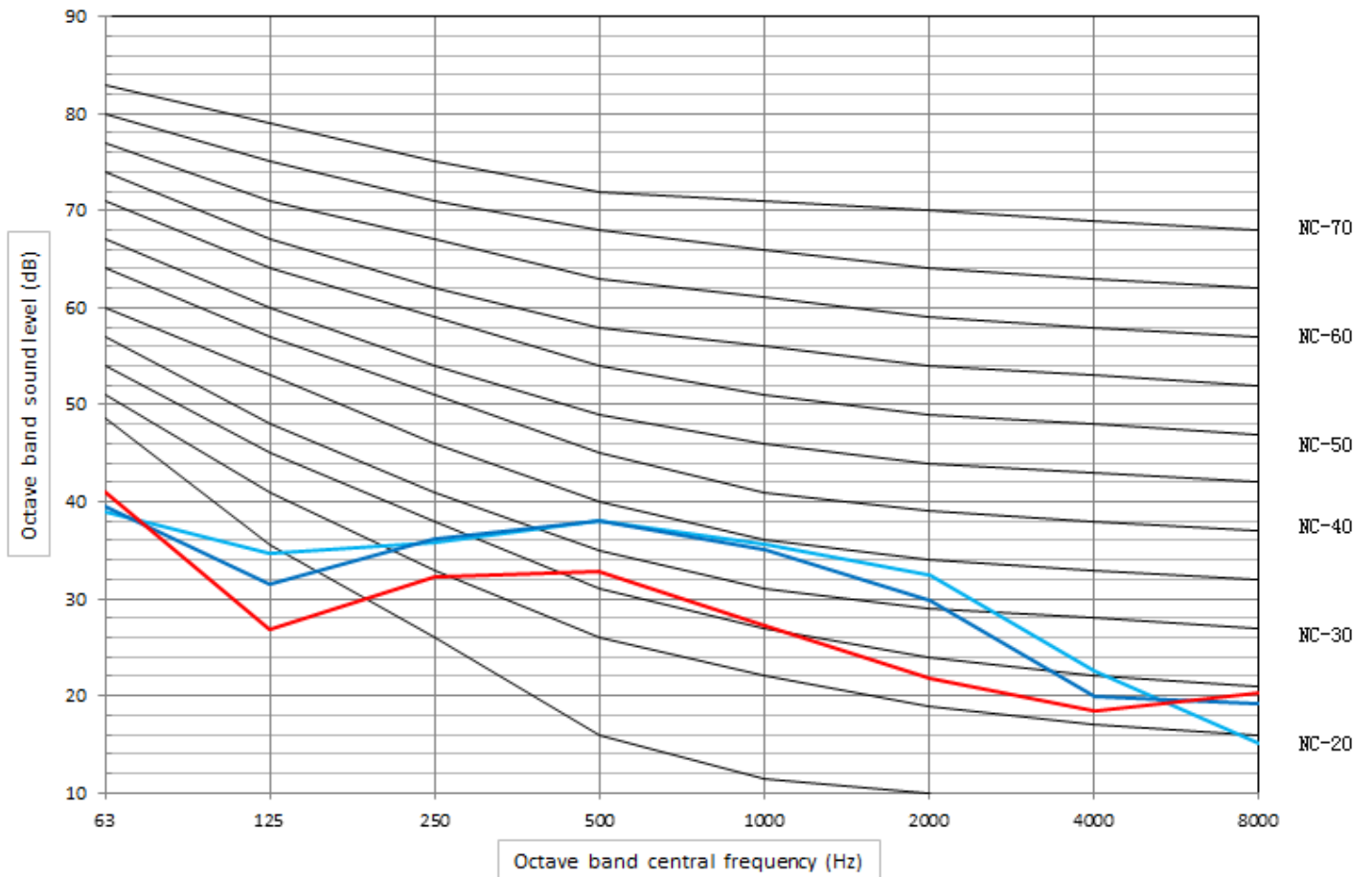

MDVF-500D303E

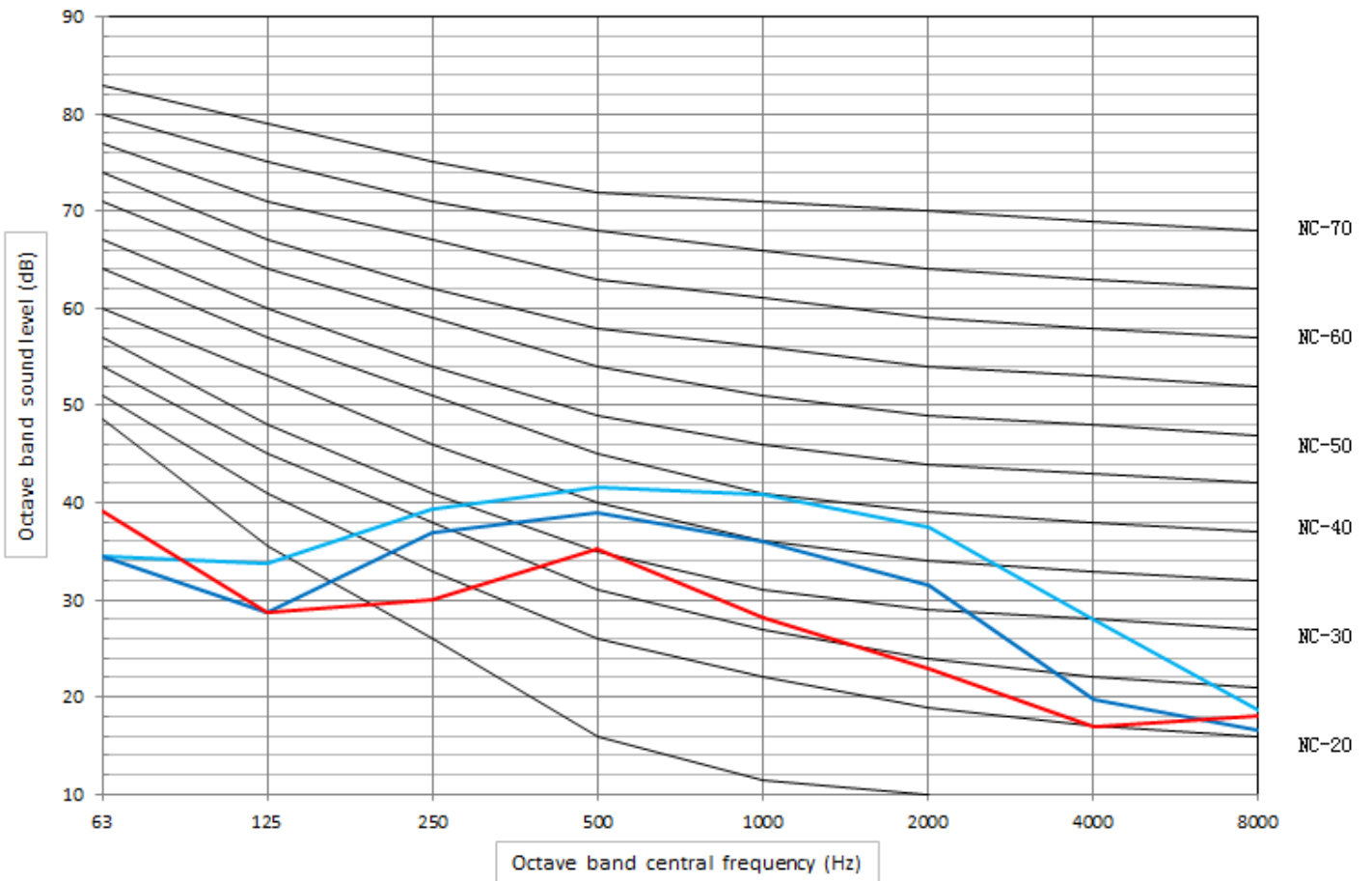

MDVF-600D303E

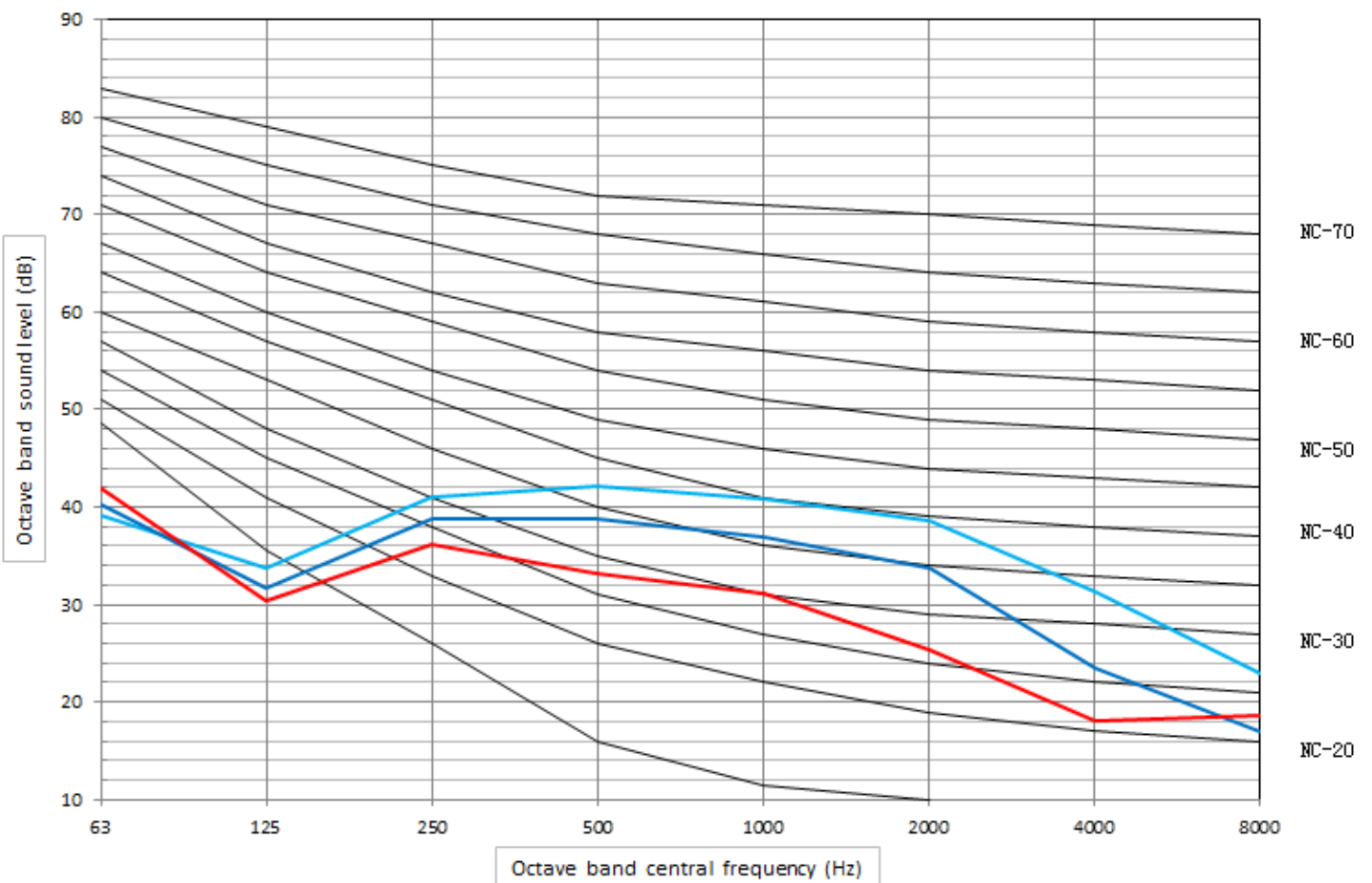

MDVF-800D303E

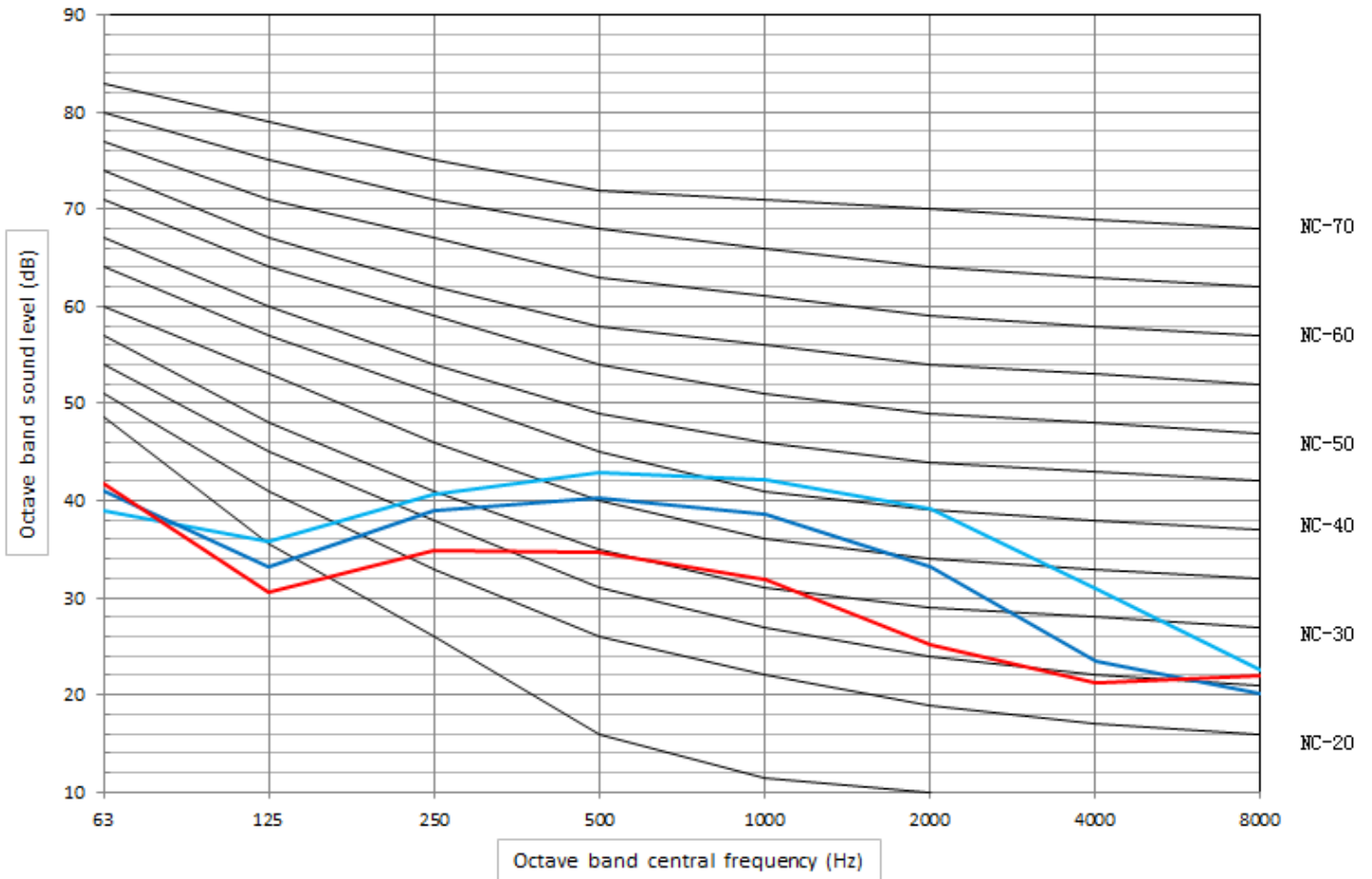

MDVF-1000D303E

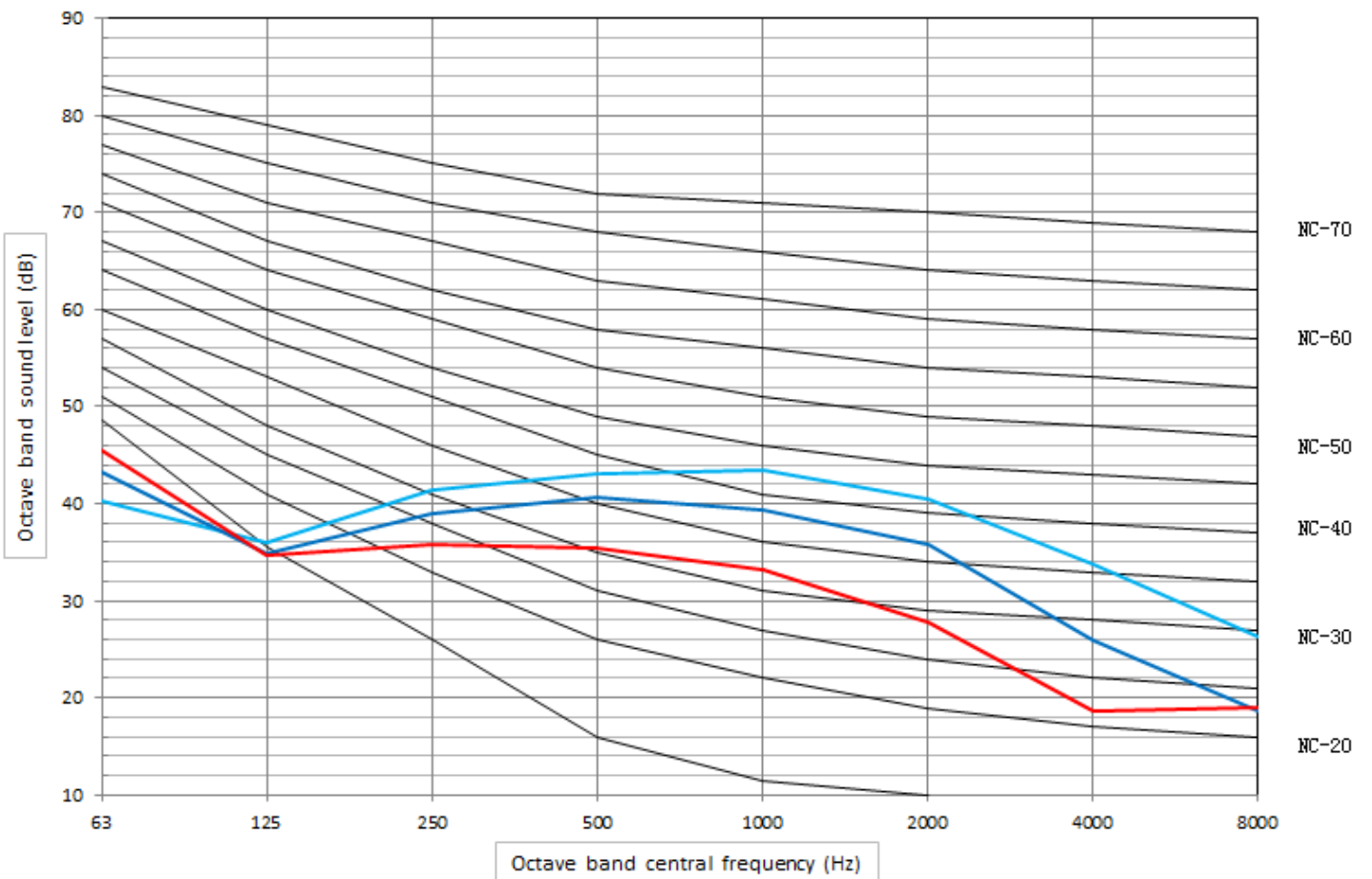

MDVF-1200D303E

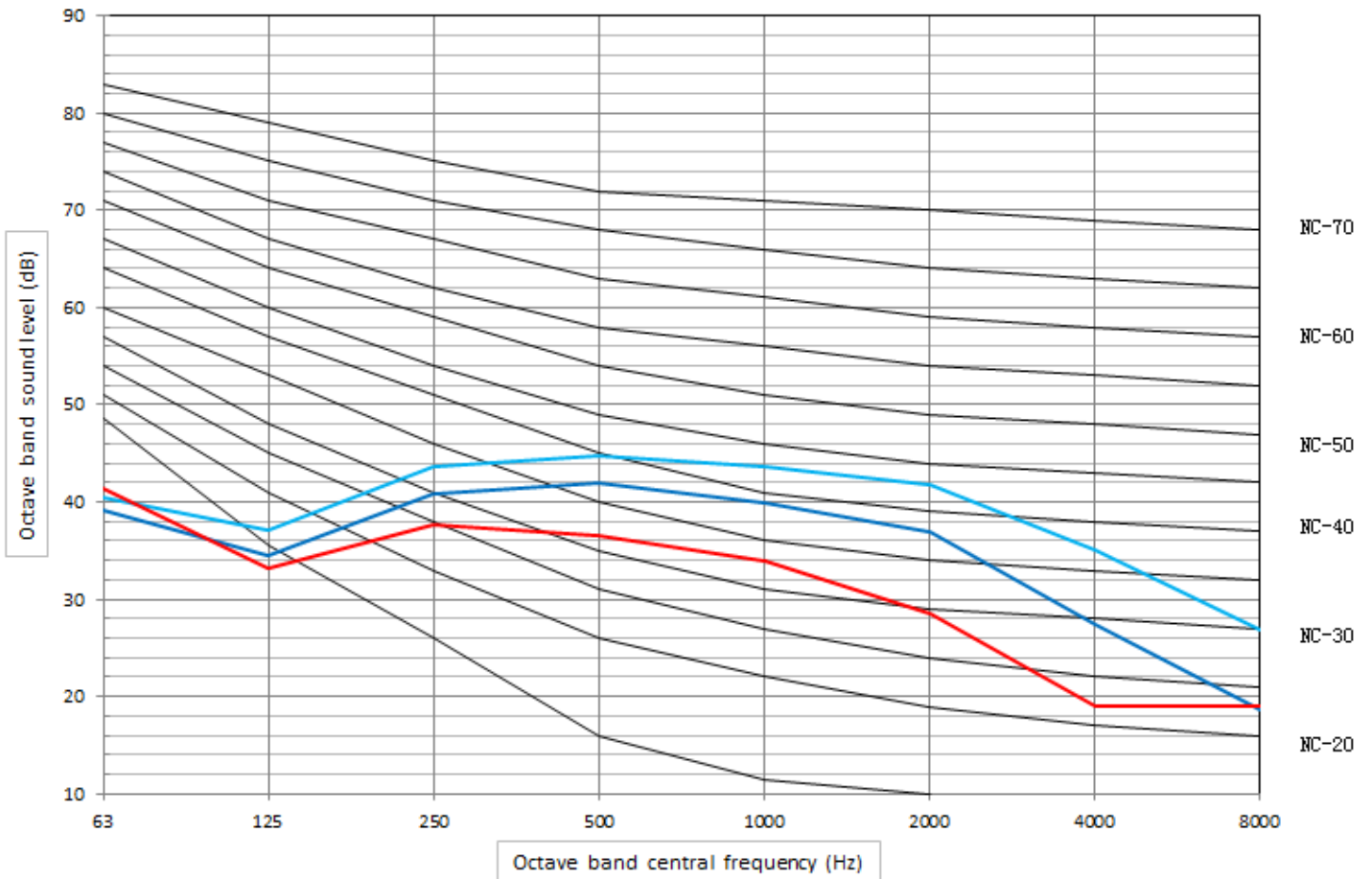

MDVF-1400D303E

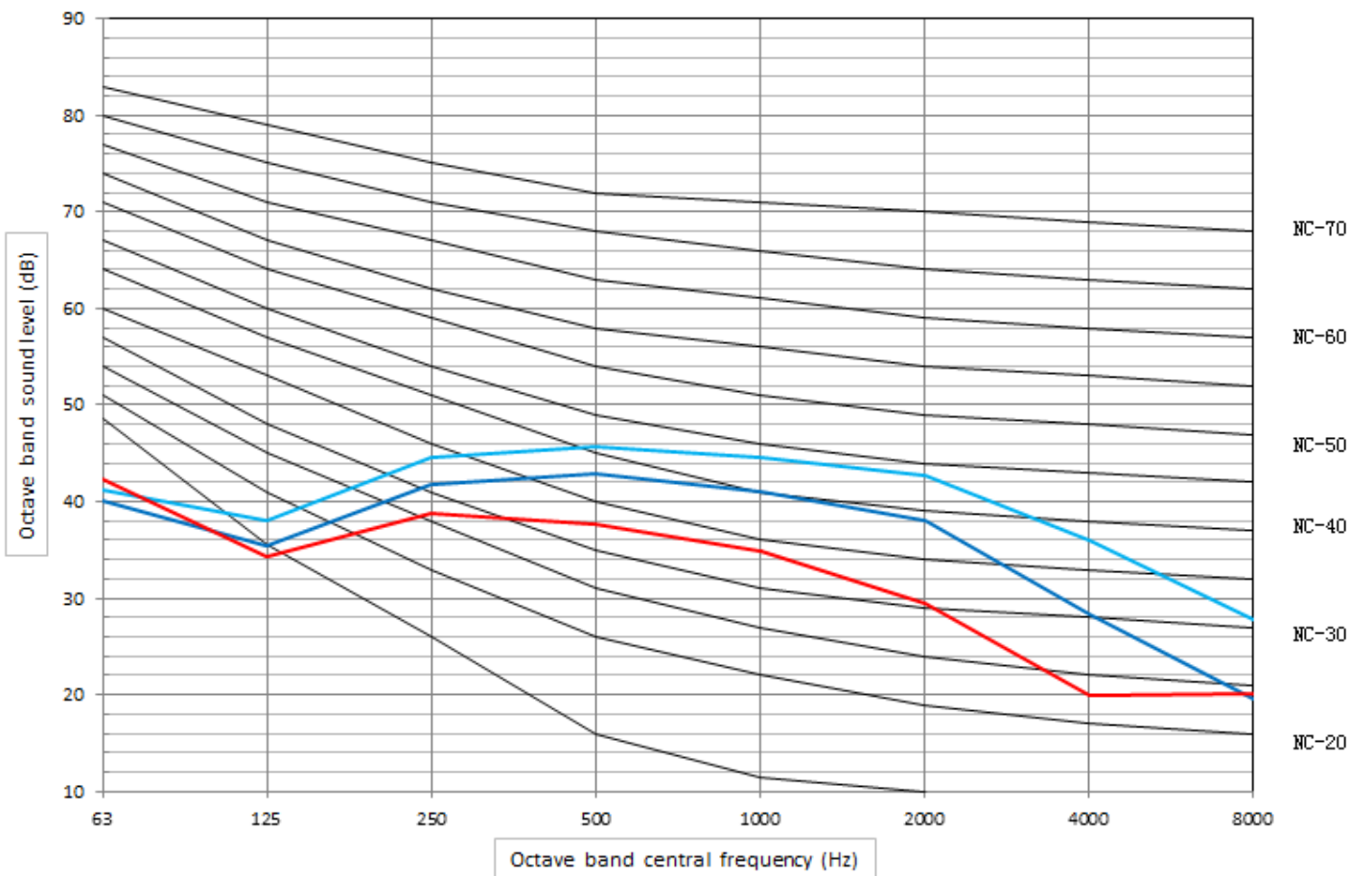

MDVF-200D304E

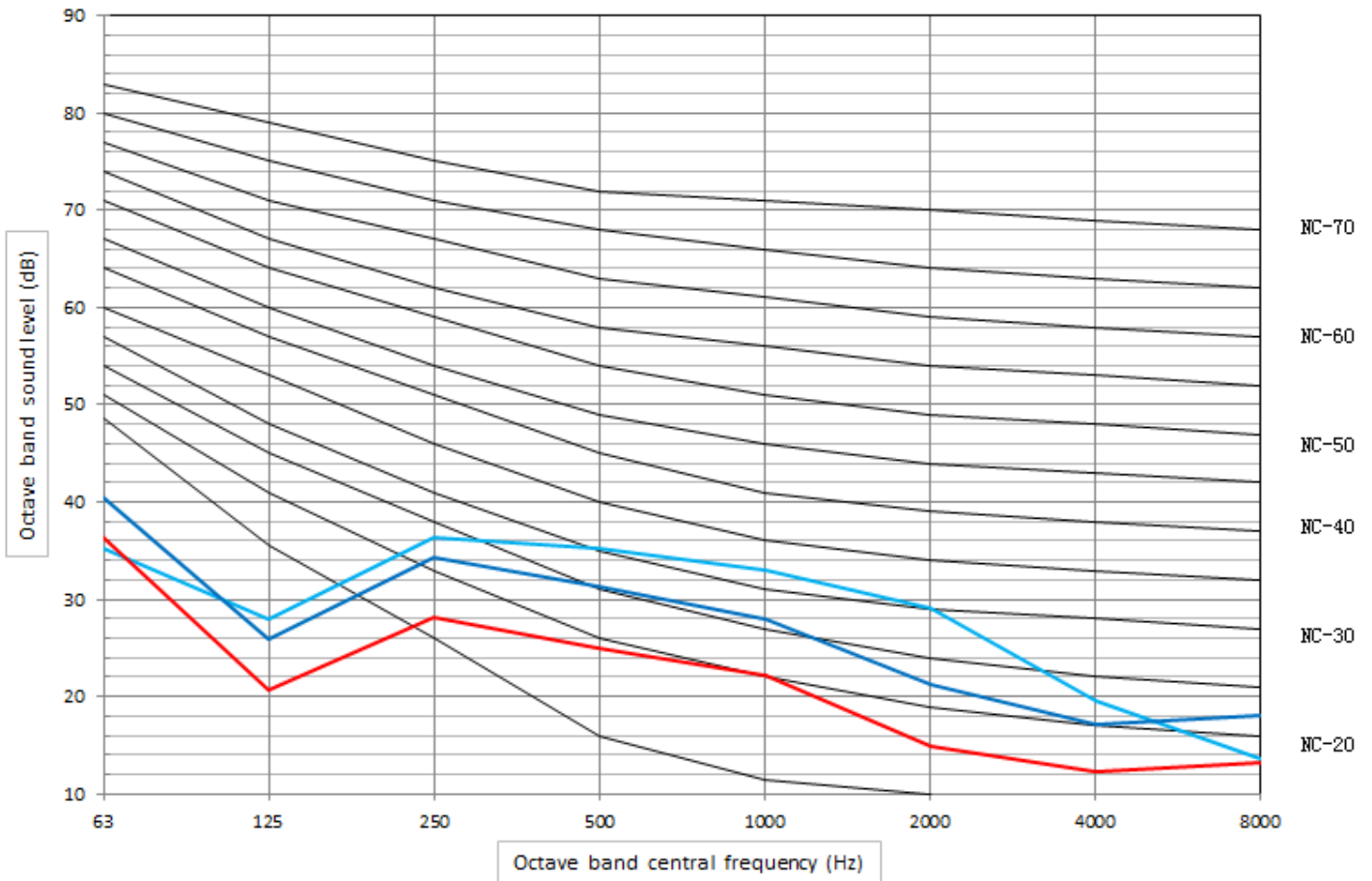

MDVF-300D304E

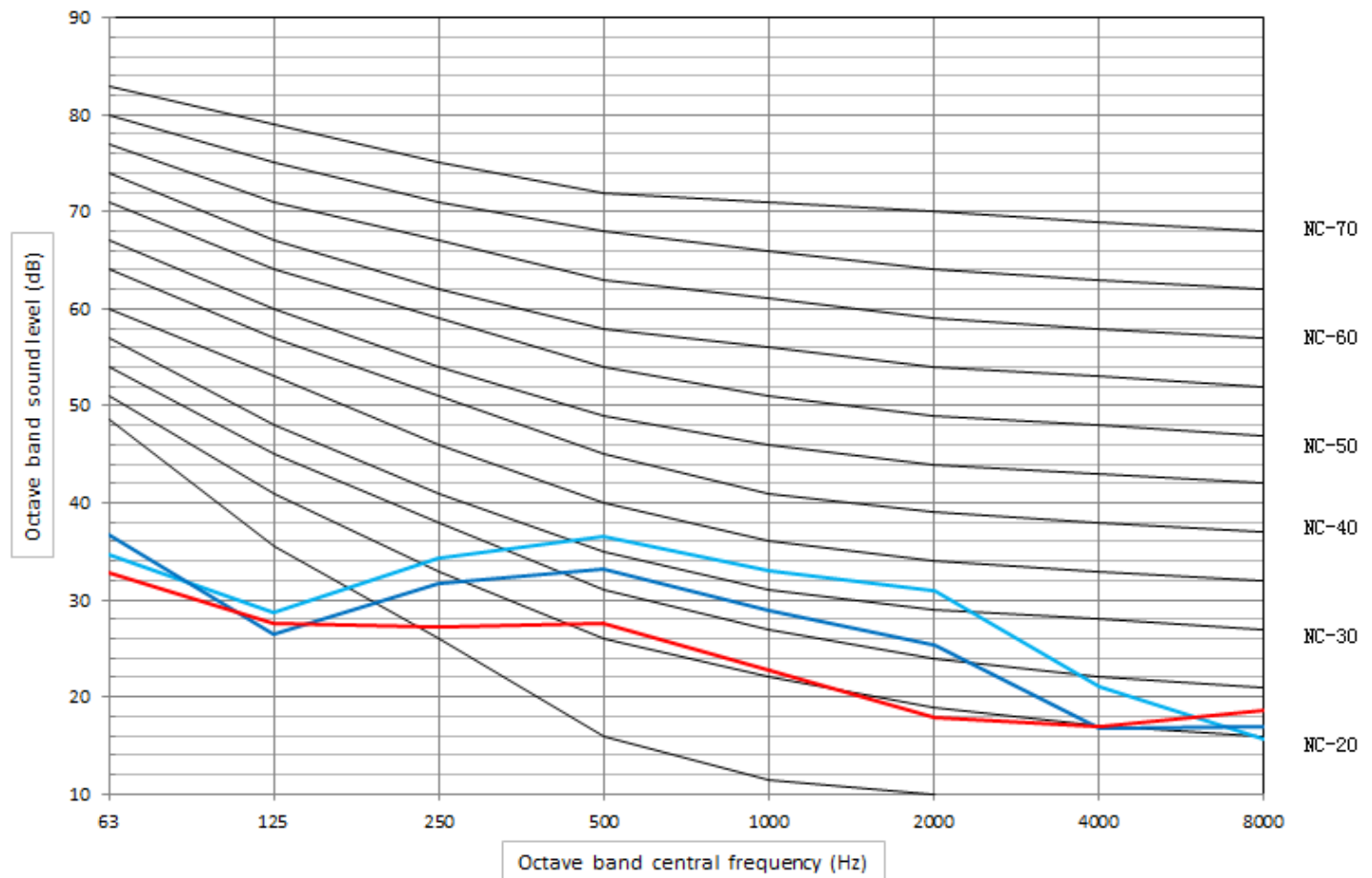

MDVF-400D304E

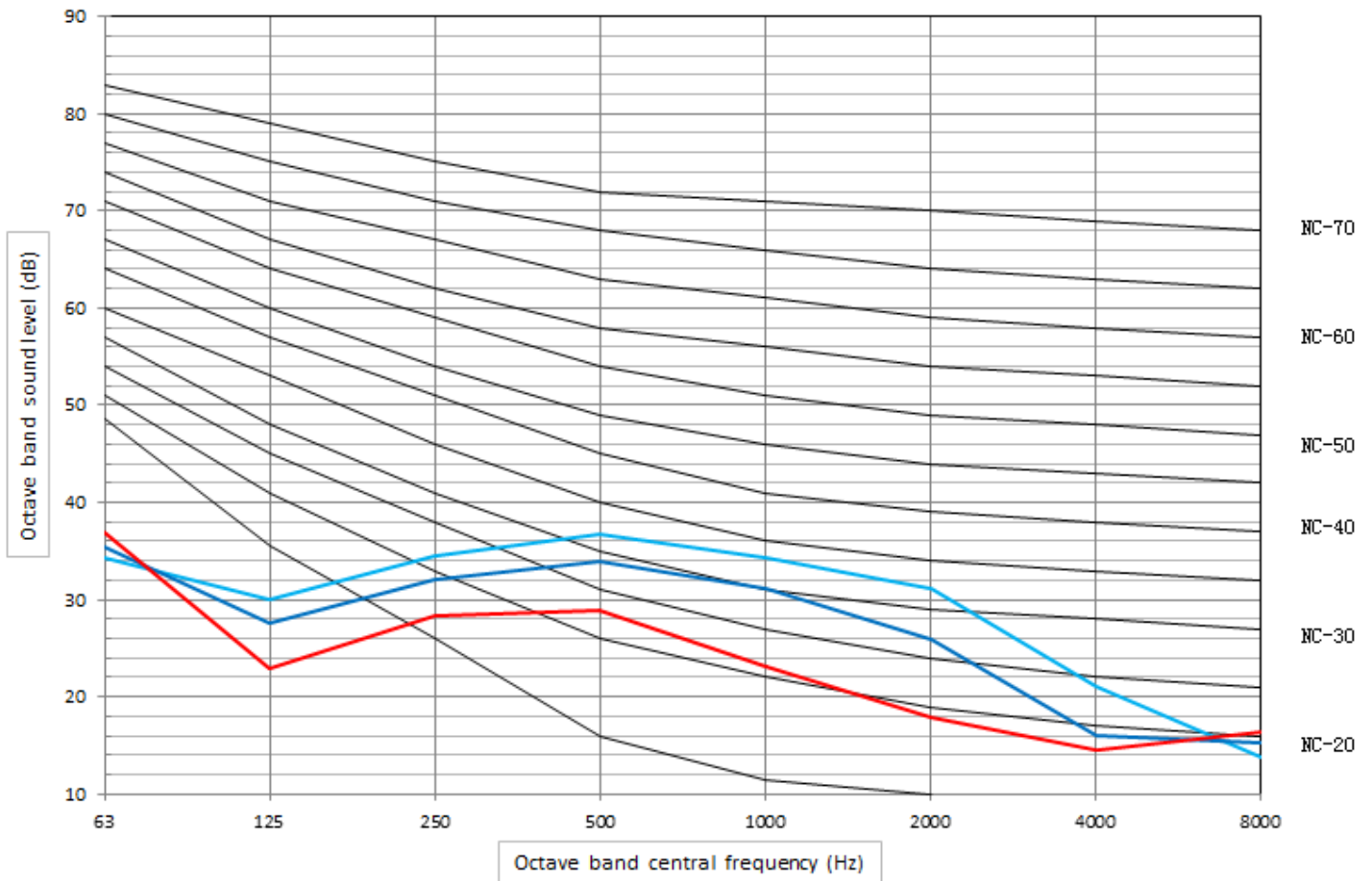

MDVF-500D304E

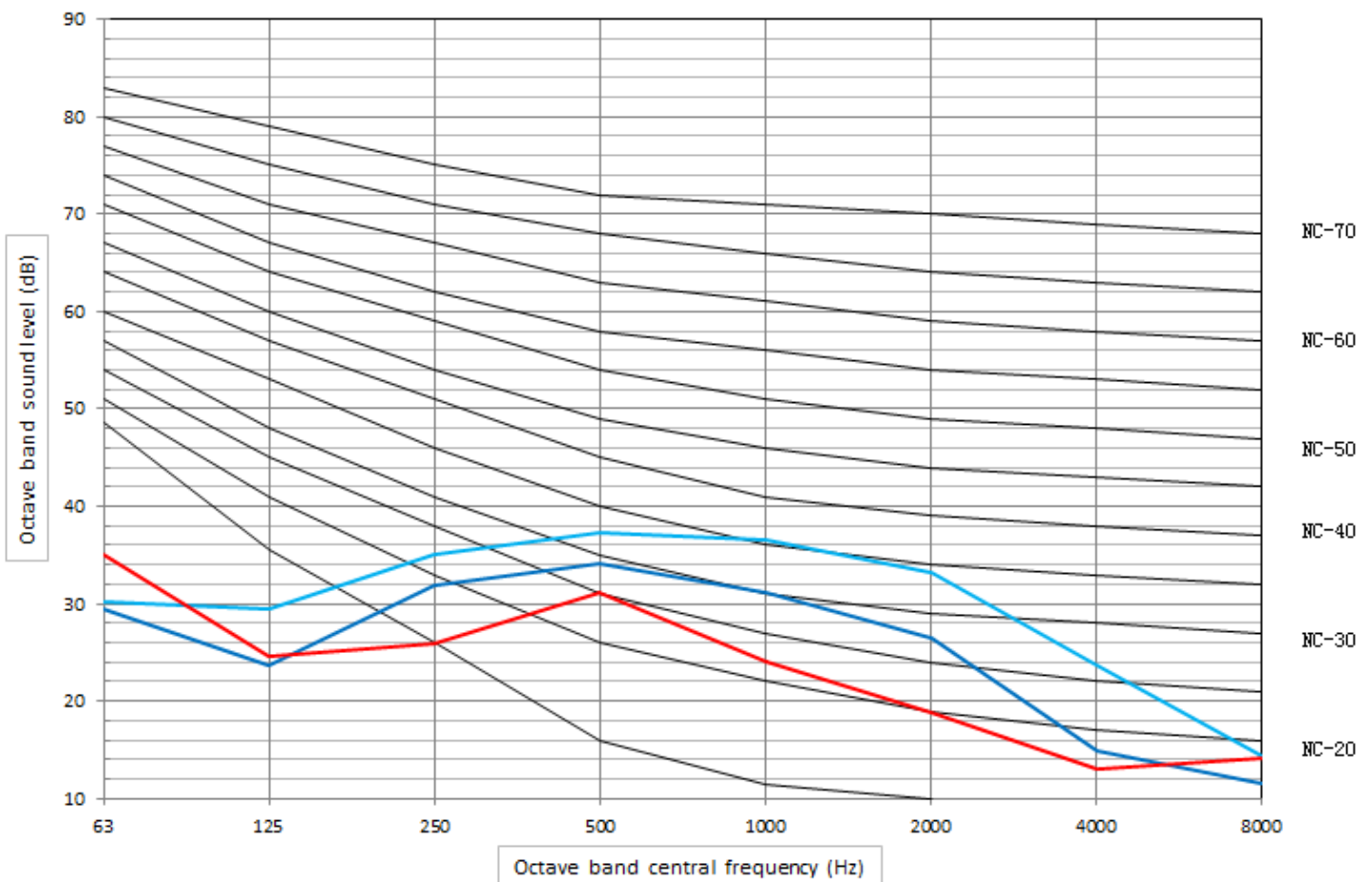

MDVF-600D304E

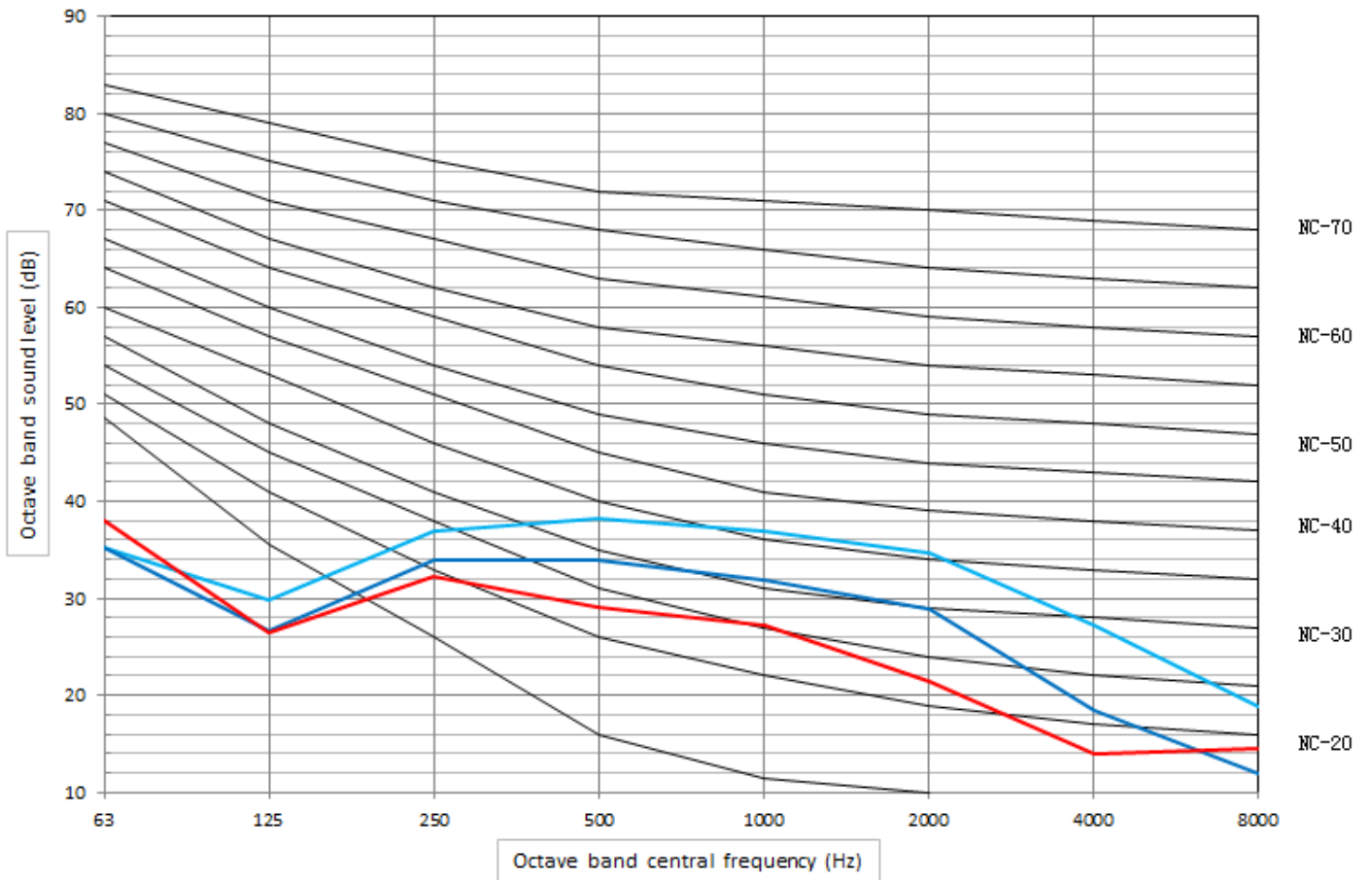

MDVF-800D304E

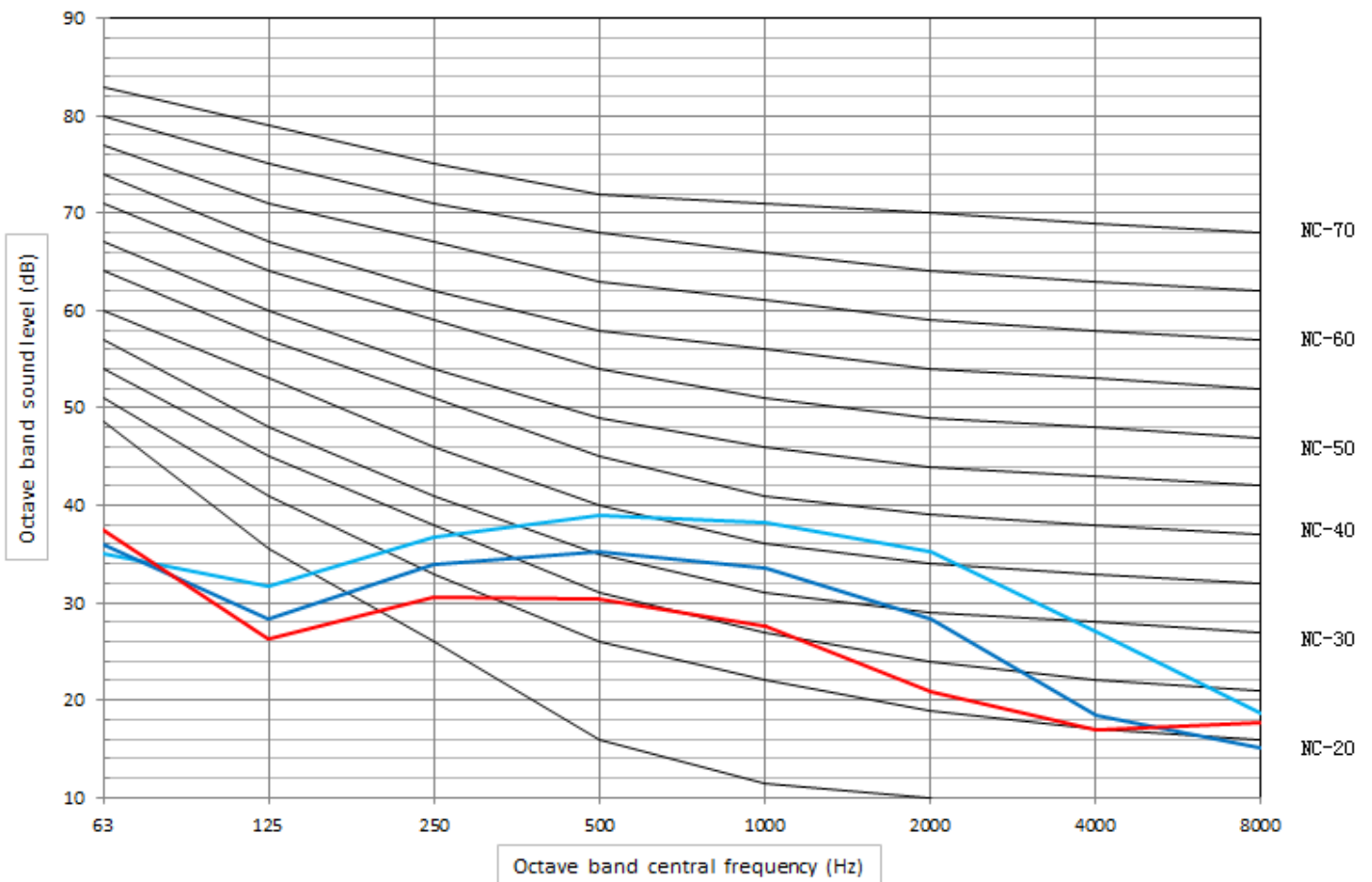

MDVF-1000D304E

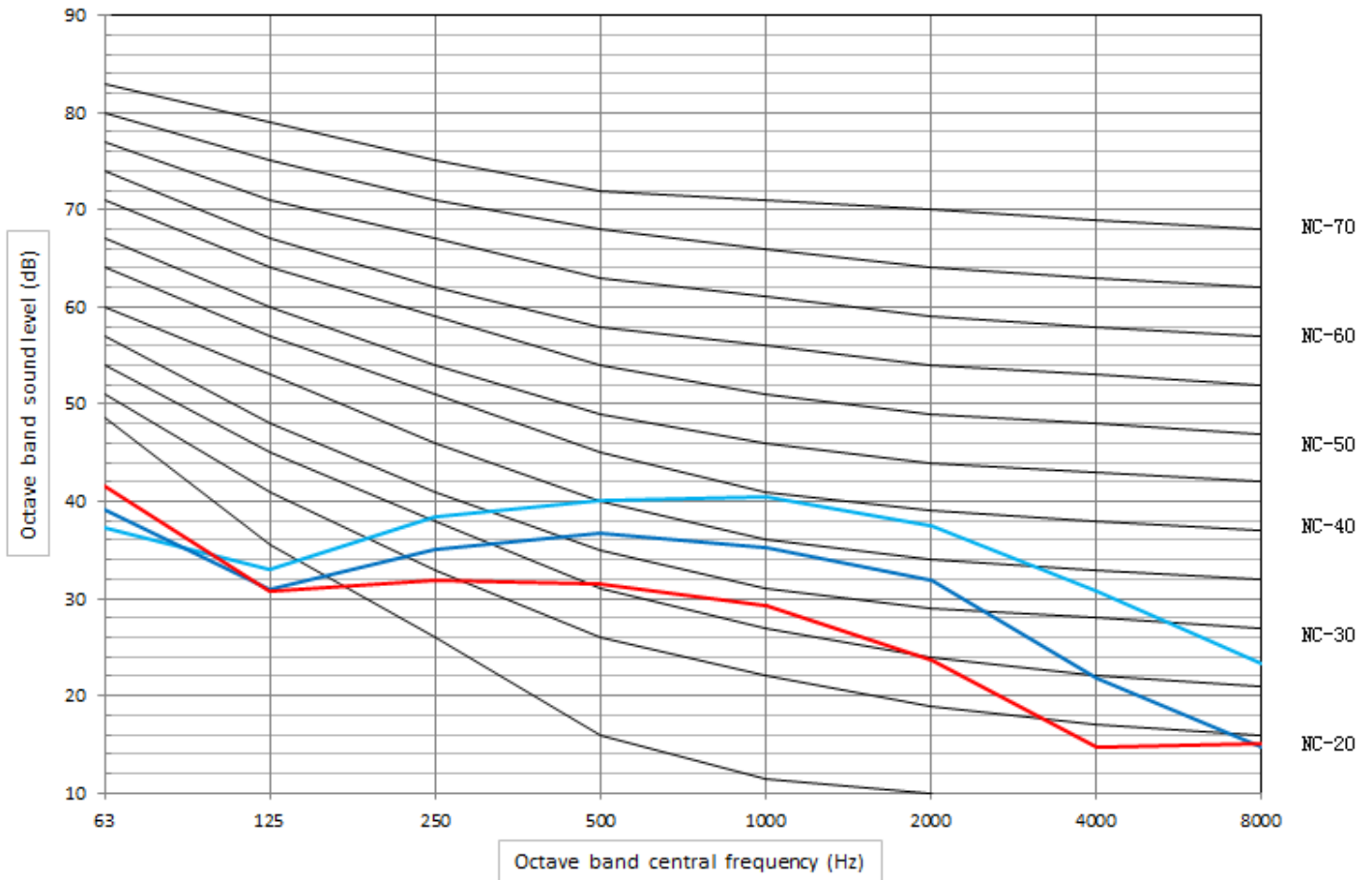

MDVF-1200D304E

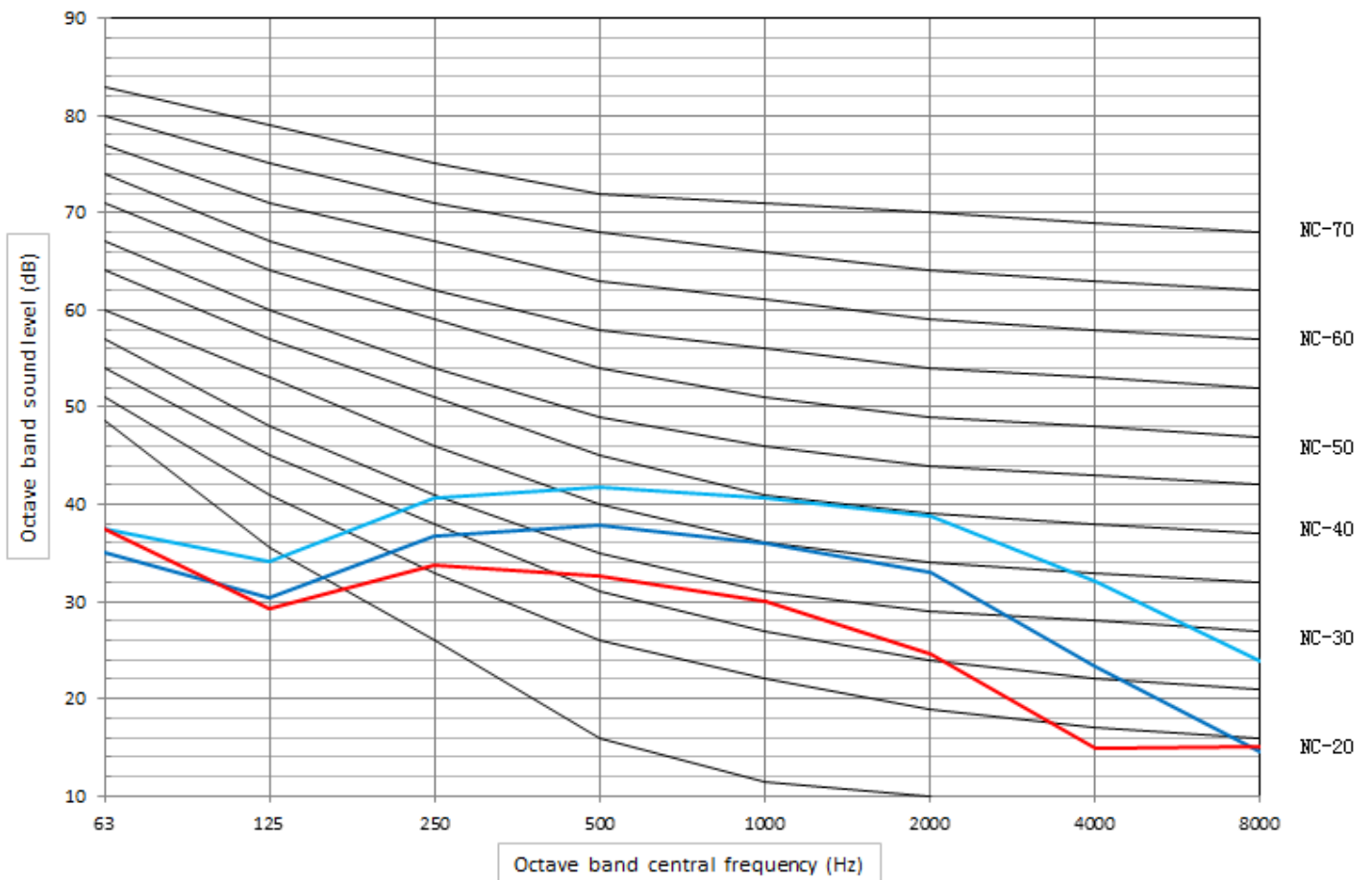

MDVF-1400D304E

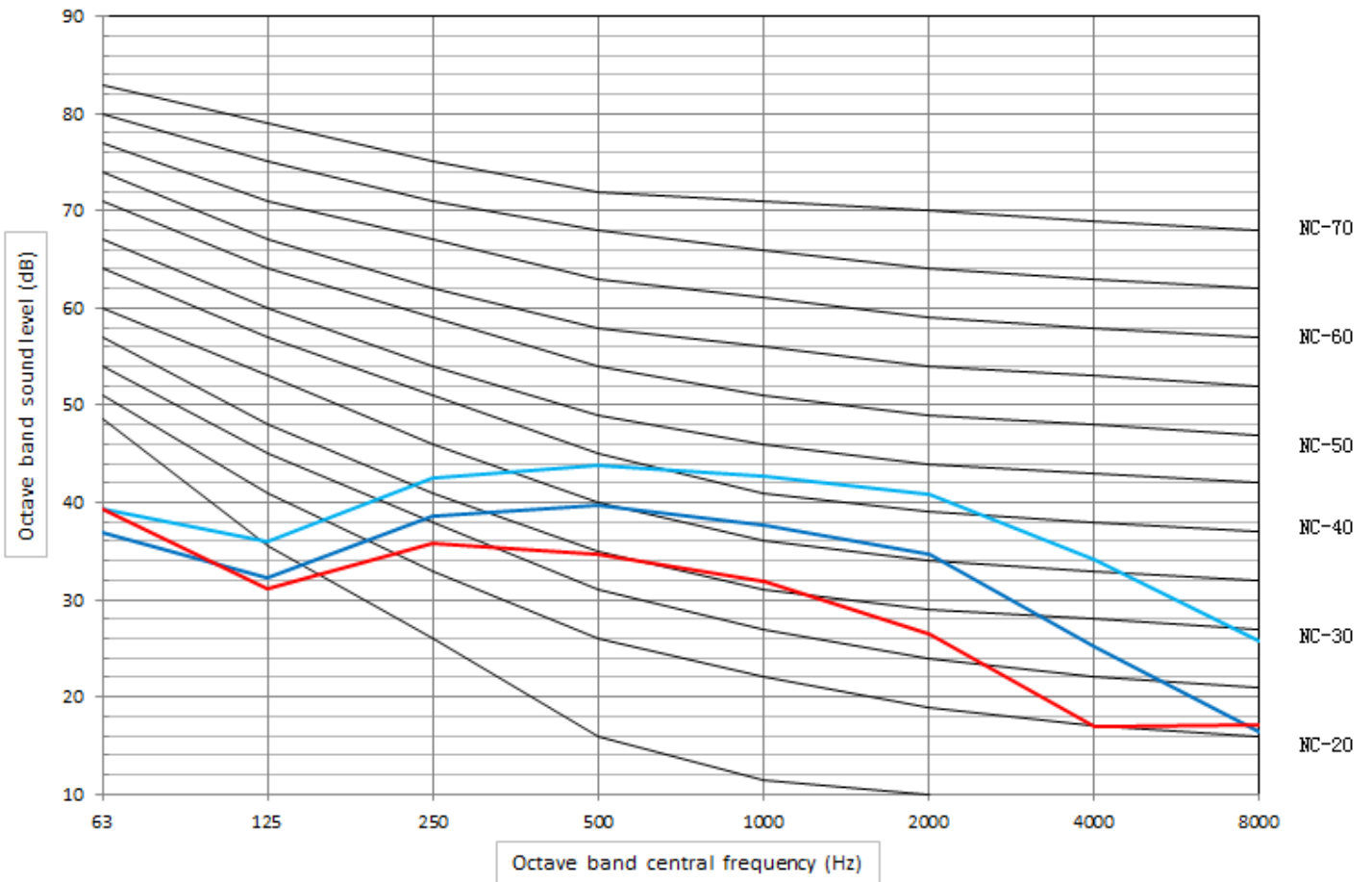

9. Wiring Diagrams

3-row 12Pa duct units (reserved super high fan speed)

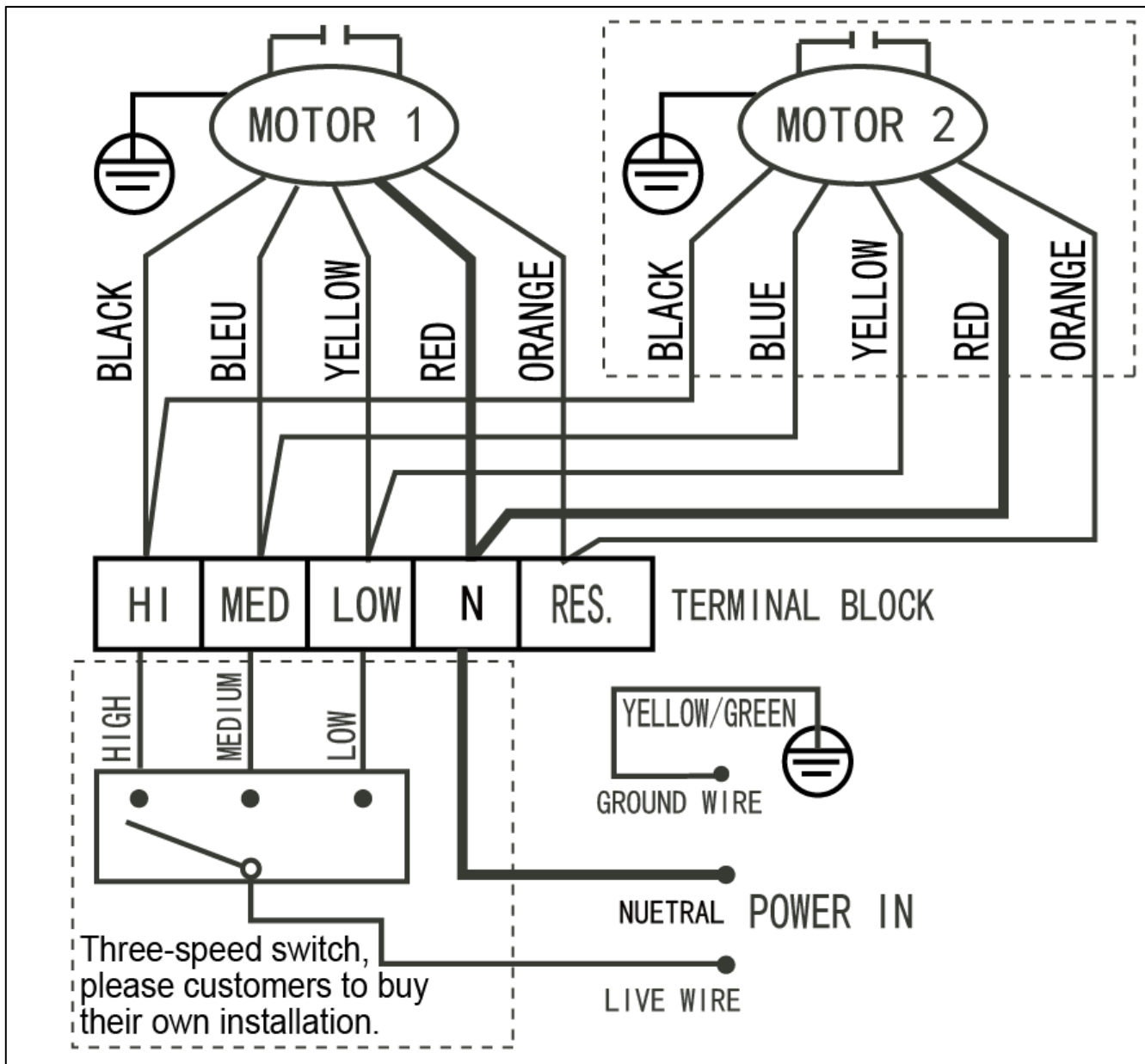

Notes:

- Black: high fan speed; Orange: Super high fan speed; Blue: medium fan speed; Yellow: low fan speed.
- Terminal 5 connects with reserved speed.
- Please connect wires properly, or the motor would be burned-out.

2-row duct units, 3-row 30Pa duct units, 4-row duct units

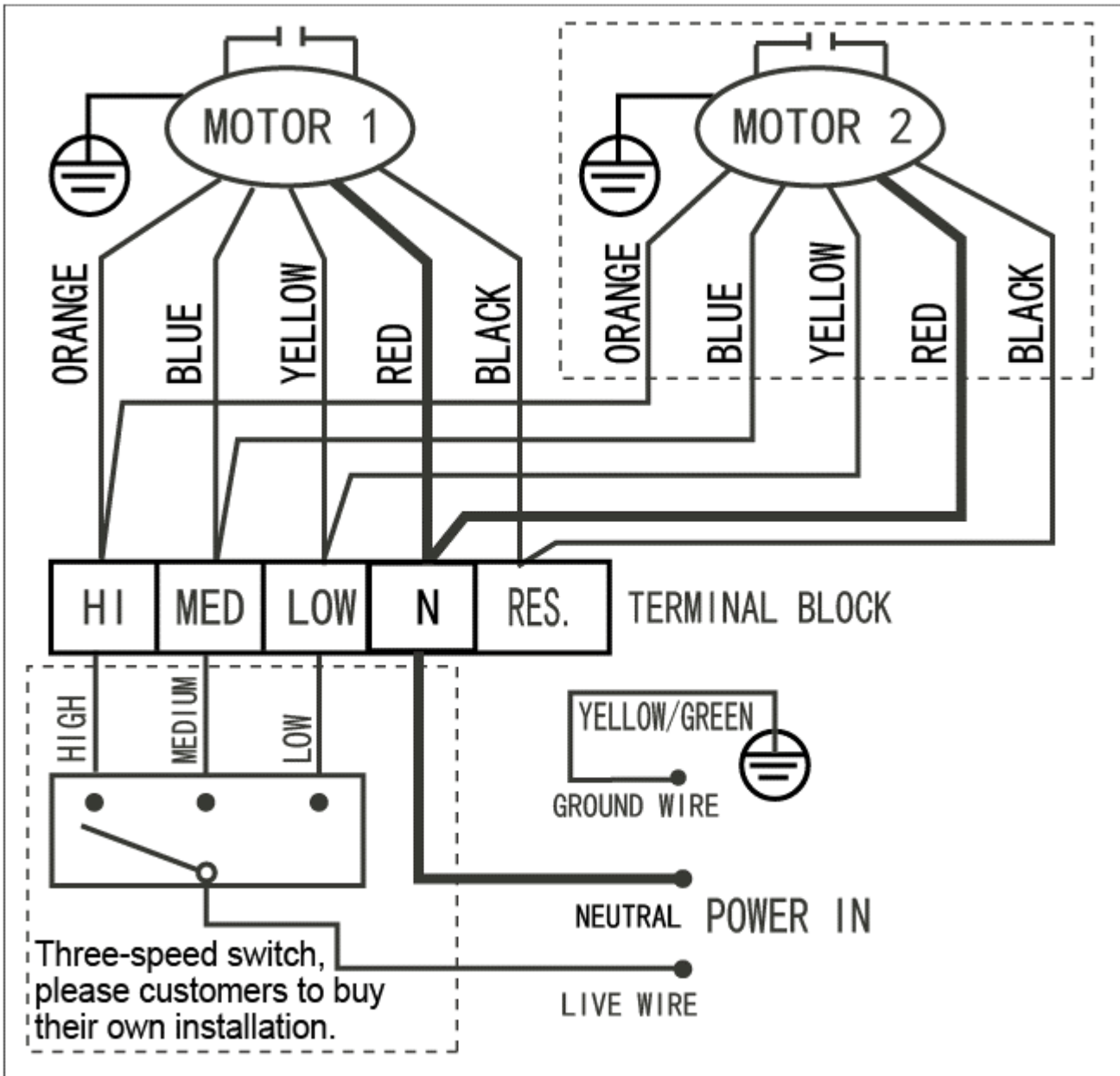

Notes:

- Orange: high fan speed; Black: Super high fan speed; Blue: medium fan speed; Yellow: low fan speed.
- Terminal 5 connects with reserved speed.
- Please connect wires properly, or the motor would be burned-out.

10. Capacity Tables

2-row Duct Cooling capacity

MDVF-200D302E																						
EWT	ΔT	Indoor temp (W.B.)	Indoor temperature (D.B.)																			
			21				23				25				27				29			
°C	°C	°C	TC	SC	WF	WPD	TC	SC	WF	WPD	TC	SC	WF	WPD	TC	SC	WF	WPD	TC	SC	WF	WPD
			kW	kW	m³/h	kPa	kW	kW	m³/h	kPa	kW	kW	m³/h	kPa	kW	kW	m³/h	kPa	kW	kW	m³/h	kPa
5	3	15	1.86	1.50	0.53	11.23	1.84	1.74	0.53	11.01	1.97	1.97	0.57	12.38	2.20	2.20	0.63	14.97	2.42	2.42	0.69	17.48
		17	2.55	1.51	0.73	19.38	2.53	1.74	0.73	19.16	2.51	1.97	0.72	18.62	2.49	2.20	0.71	18.38	2.47	2.43	0.70	18.08
		19	-	-	-	-	3.27	1.74	0.93	29.45	3.25	1.97	0.93	29.11	3.23	2.20	0.92	28.78	3.20	2.43	0.92	28.45
		20	-	-	-	-	3.66	1.74	1.05	35.92	3.64	1.98	1.04	35.53	3.62	2.21	1.03	35.14	3.59	2.43	1.03	34.75
	4	15	1.52	1.35	0.33	4.84	1.58	1.58	0.34	5.20	1.82	1.82	0.39	6.59	2.05	2.05	0.44	8.08	2.28	2.28	0.49	9.67
		17	2.23	1.36	0.48	9.28	2.21	1.60	0.48	9.17	2.19	1.83	0.47	9.05	2.17	2.06	0.47	8.89	2.29	2.29	0.49	9.71
		19	-	-	-	-	2.95	1.60	0.63	14.90	2.93	1.83	0.63	14.73	2.91	2.06	0.62	14.56	2.89	2.29	0.62	14.40
		20	-	-	-	-	3.35	1.60	0.72	18.72	3.33	1.84	0.72	18.51	3.30	2.07	0.71	18.31	3.28	2.30	0.71	18.10
	5	15	1.19	1.18	0.20	1.78	1.43	1.43	0.25	2.84	1.67	1.67	0.29	3.85	1.91	1.91	0.33	4.82	2.13	2.13	0.37	5.82
		17	1.88	1.21	0.32	4.69	1.86	1.44	0.32	4.63	1.84	1.68	0.32	4.54	1.90	1.90	0.33	4.82	2.14	2.14	0.37	5.84
		19	-	-	-	-	2.61	1.45	0.45	8.23	2.60	1.69	0.45	8.13	2.58	1.92	0.44	8.03	2.56	2.15	0.44	7.93
		20	-	-	-	-	3.01	1.46	0.52	10.48	2.99	1.69	0.51	10.36	2.97	1.92	0.51	10.24	2.95	2.15	0.51	10.12
6	15	1.09	1.09	0.16	0.87	1.30	1.30	0.19	1.39	1.52	1.52	0.22	2.12	1.75	1.75	0.25	2.98	1.99	1.99	0.28	3.77	
	17	1.50	1.05	0.21	2.05	1.49	1.29	0.21	1.99	1.52	1.50	0.22	2.10	1.76	1.76	0.25	2.99	1.99	1.99	0.28	3.79	
	19	-	-	-	-	2.26	1.31	0.32	4.70	2.24	1.54	0.32	4.64	2.23	1.77	0.32	4.57	2.20	2.00	0.32	4.50	
	20	-	-	-	-	2.66	1.31	0.38	6.22	2.65	1.55	0.38	6.14	2.63	1.78	0.38	6.07	2.61	2.01	0.37	5.99	
7	3	15	1.31	1.26	0.38	6.04	1.50	1.50	0.43	7.59	1.73	1.73	0.50	9.73	1.96	1.96	0.56	12.06	2.19	2.19	0.63	14.58
		17	2.01	1.27	0.58	12.62	2.00	1.50	0.57	12.46	1.98	1.74	0.57	12.25	1.97	1.97	0.56	12.14	2.20	2.20	0.63	14.63
		19	-	-	-	-	2.74	1.51	0.79	21.46	2.72	1.74	0.78	21.21	2.70	1.97	0.77	20.96	2.69	2.20	0.77	20.88
		20	-	-	-	-	3.13	1.51	0.90	27.11	3.11	1.74	0.89	26.80	3.09	1.97	0.89	26.49	3.07	2.20	0.88	26.18
	4	15	1.11	1.11	0.24	2.68	1.35	1.35	0.29	3.90	1.59	1.59	0.34	5.13	1.82	1.82	0.39	6.48	2.05	2.05	0.44	7.94
		17	1.67	1.12	0.36	5.60	1.65	1.36	0.36	5.50	1.64	1.59	0.35	5.39	1.83	1.83	0.39	6.50	2.06	2.06	0.44	7.96
		19	-	-	-	-	2.41	1.37	0.52	10.43	2.39	1.60	0.51	10.31	2.37	1.83	0.51	10.18	2.35	2.06	0.51	10.03
		20	-	-	-	-	2.80	1.37	0.61	13.62	2.78	1.60	0.60	13.46	2.76	1.84	0.60	13.31	2.75	2.07	0.59	13.15
	5	15	0.98	0.98	0.17	1.11	1.20	1.20	0.21	1.92	1.44	1.44	0.25	2.90	1.68	1.68	0.29	3.81	1.91	1.91	0.33	4.75
		17	1.28	0.97	0.22	2.26	1.27	1.20	0.22	2.18	1.44	1.44	0.25	2.92	1.68	1.68	0.29	3.83	1.91	1.91	0.33	4.77
		19	-	-	-	-	2.05	1.22	0.35	5.36	2.03	1.46	0.35	5.29	2.03	1.72	0.36	11.90	1.99	1.92	0.34	5.10
		20	-	-	-	-	2.45	1.22	0.42	7.25	2.43	1.46	0.42	7.16	2.41	1.69	0.41	7.08	2.39	1.92	0.41	6.98
6	15	0.87	0.87	0.12	0.60	1.09	1.09	0.16	0.91	1.30	1.30	0.19	1.48	1.53	1.53	0.22	2.24	1.76	1.76	0.25	3.04	
	17	1.00	0.86	0.14	0.75	1.09	1.09	0.16	0.91	1.31	1.31	0.19	1.48	1.53	1.53	0.22	2.25	1.77	1.77	0.25	3.05	
	19	-	-	-	-	1.65	1.07	0.24	2.68	1.64	1.30	0.24	2.62	1.61	1.54	0.23	2.54	1.77	1.77	0.25	3.06	
	20	-	-	-	-	2.07	1.08	0.30	4.02	2.06	1.31	0.30	3.96	2.04	1.55	0.29	3.90	2.02	1.78	0.29	3.83	
9	3	15	1.02	1.02	0.29	3.92	1.26	1.26	0.36	5.60	1.50	1.50	0.43	7.49	1.73	1.73	0.50	9.59	1.96	1.96	0.56	11.87
		17	1.44	1.03	0.41	7.02	1.42	1.27	0.41	6.87	1.50	1.49	0.43	7.48	1.73	1.73	0.50	9.62	1.96	1.96	0.56	11.91
		19	-	-	-	-	2.17	1.27	0.62	14.21	2.16	1.51	0.62	14.03	2.14	1.74	0.61	13.82	2.12	1.97	0.61	13.57
		20	-	-	-	-	2.57	1.27	0.74	18.91	2.55	1.51	0.73	18.68	2.53	1.74	0.73	18.45	2.51	1.97	0.72	18.22
	4	15	0.88	0.88	0.19	1.56	1.12	1.12	0.24	2.77	1.36	1.36	0.29	3.88	1.59	1.59	0.34	5.03	1.82	1.82	0.39	6.35
		17	1.05	0.88	0.23	2.45	1.11	1.09	0.24	2.73	1.36	1.36	0.29	3.90	1.59	1.59	0.34	5.05	1.82	1.82	0.39	6.37
		19	-	-	-	-	1.81	1.13	0.39	6.31	1.80	1.36	0.39	6.20	1.77	1.60	0.38	6.08	1.82	1.80	0.39	6.33
		20	-	-	-	-	2.21	1.13	0.48	8.85	2.19	1.37	0.47	8.74	2.18	1.60	0.47	8.62	2.16	1.83	0.46	8.48
	5	15	0.76	0.76	0.13	0.63	0.98	0.98	0.17	1.14	1.21	1.21	0.21	1.98	1.44	1.44	0.25	2.91	1.68	1.68	0.29	3.77
		17	0.77	0.77	0.13	0.63	0.98	0.98	0.17	1.15	1.21	1.21	0.21	1.99	1.45	1.45	0.25	2.92	1.68	1.68	0.29	3.78
		19	-	-	-	-	1.41	0.98	0.24	2.80	1.39	1.21	0.24	2.72	1.44	1.42	0.25	2.89	1.69	1.69	0.29	3.79
		20	-	-	-	-	1.83	0.99	0.31	4.36	1.81	1.22	0.31	4.29	1.79	1.46	0.31	4.21	1.77	1.69	0.30	4.13
6	15	0.64	0.64	0.09	0.42	0.87	0.87	0.12	0.58	1.09	1.09	0.16	0.93	1.30	1.30	0.19	1.53	1.53	1.53	0.22	2.28	
	17	0.64	0.64	0.09	0.42	0.87	0.87	0.12	0.58	1.09	1.09	0.16	0.94	1.31	1.31	0.19	1.53	1.54	1.54	0.22	2.29	
	19	-	-	-	-	1.07	0.86	0.15	0.90	1.08	1.06	0.16	0.92	1.31	1.31	0.19	1.54	1.54	1.54	0.22	2.30	
	20	-	-	-	-	1.41	0.84	0.20	1.87	1.39	1.07	0.20	1.81	1.37	1.31	0.20	1.75	1.54	1.54	0.22	2.31	

Continued:

MDVF-200D302E																							
EWT	ΔT	Indoor temp (W.B.)	Indoor temperature (D.B.)																				
			21				23				25				27				29				
			TC	SC	WF	WPD	TC	SC	WF	WPD	TC	SC	WF	WPD	TC	SC	WF	WPD	TC	SC	WF	WPD	
°C	°C	°C	kW	kW	m³/h	kPa	kW	kW	m³/h	kPa	kW	kW	m³/h	kPa	kW	kW	m³/h	kPa	kW	kW	m³/h	kPa	
11	3	15	0.78	0.78	0.22	2.36	1.03	1.03	0.29	3.82	1.26	1.26	0.36	5.44	1.50	1.50	0.43	7.27	1.73	1.73	0.49	9.30	
		17	0.81	0.78	0.23	2.51	1.03	1.03	0.29	3.83	1.27	1.27	0.36	5.46	1.50	1.50	0.43	7.30	1.73	1.73	0.49	9.33	
		19	-	-	-	-	1.56	1.03	0.45	7.83	1.54	1.27	0.44	7.67	1.53	1.50	0.44	7.56	1.73	1.73	0.49	9.36	
		20	-	-	-	-	1.96	1.04	0.56	11.54	1.94	1.27	0.55	11.38	1.92	1.51	0.55	11.19	1.90	1.74	0.54	10.97	
	4	15	0.66	0.66	0.14	0.72	0.88	0.88	0.19	1.58	1.12	1.12	0.24	2.71	1.36	1.36	0.29	3.76	1.59	1.59	0.34	4.92	
		17	0.66	0.66	0.14	0.73	0.88	0.88	0.19	1.58	1.12	1.12	0.24	2.71	1.36	1.36	0.29	3.77	1.59	1.59	0.34	4.94	
		19	-	-	-	-	1.16	0.89	0.25	2.87	1.15	1.12	0.25	2.83	1.36	1.36	0.29	3.78	1.60	1.60	0.34	4.95	
		20	-	-	-	-	1.57	0.89	0.34	4.84	1.56	1.13	0.33	4.75	1.54	1.37	0.33	4.64	1.59	1.56	0.34	4.90	
	5	15	0.54	0.54	0.09	0.41	0.77	0.77	0.13	0.63	0.98	0.98	0.17	1.20	1.21	1.21	0.21	2.05	1.45	1.45	0.25	2.89	
		17	0.54	0.54	0.09	0.41	0.77	0.77	0.13	0.63	0.99	0.99	0.17	1.20	1.21	1.21	0.21	2.06	1.45	1.45	0.25	2.90	
		19	-	-	-	-	0.82	0.77	0.14	0.73	0.99	0.99	0.17	1.21	1.22	1.22	0.21	2.07	1.46	1.46	0.25	2.91	
		20	-	-	-	-	1.15	0.74	0.20	1.80	1.13	0.98	0.19	1.73	1.21	1.19	0.21	2.04	1.46	1.46	0.25	2.92	
	6	15	0.42	0.42	0.06	0.26	0.65	0.65	0.09	0.40	0.87	0.87	0.13	0.57	1.09	1.09	0.16	0.97	1.31	1.31	0.19	1.59	
		17	0.42	0.42	0.06	0.26	0.65	0.65	0.09	0.40	0.87	0.87	0.13	0.57	1.09	1.09	0.16	0.98	1.31	1.31	0.19	1.60	
		19	-	-	-	-	0.65	0.64	0.09	0.40	0.88	0.88	0.13	0.57	1.09	1.09	0.16	0.98	1.31	1.31	0.19	1.61	
		20	-	-	-	-	0.83	0.64	0.12	0.53	0.87	0.84	0.12	0.56	1.09	1.09	0.16	0.98	1.31	1.31	0.19	1.61	
	13	3	15	0.55	0.55	0.16	1.01	0.79	0.79	0.23	2.43	1.03	1.03	0.30	3.83	1.26	1.26	0.36	5.44	1.50	1.50	0.43	7.26
			17	0.55	0.55	0.16	1.02	0.79	0.79	0.23	2.44	1.03	1.03	0.30	3.84	1.27	1.27	0.36	5.45	1.50	1.50	0.43	7.28
			19	-	-	-	-	0.89	0.79	0.26	3.01	1.03	1.03	0.30	3.85	1.27	1.27	0.36	5.47	1.50	1.50	0.43	7.31
			20	-	-	-	-	1.30	0.80	0.37	5.72	1.28	1.04	0.37	5.58	1.28	1.27	0.37	5.56	1.50	1.50	0.43	7.32
		4	15	0.44	0.44	0.09	0.40	0.66	0.66	0.14	0.76	0.88	0.88	0.19	1.67	1.12	1.12	0.24	2.71	1.36	1.36	0.29	3.75
			17	0.44	0.44	0.09	0.40	0.66	0.66	0.14	0.76	0.88	0.88	0.19	1.67	1.12	1.12	0.24	2.72	1.36	1.36	0.29	3.76
			19	-	-	-	-	0.66	0.65	0.14	0.76	0.89	0.89	0.19	1.68	1.13	1.13	0.24	2.73	1.36	1.36	0.29	3.77
			20	-	-	-	-	0.86	0.65	0.19	1.56	0.88	0.86	0.19	1.64	1.13	1.13	0.24	2.73	1.37	1.37	0.29	3.78
5		15	0.32	0.32	0.05	0.22	0.54	0.54	0.09	0.38	0.77	0.77	0.13	0.63	0.98	0.98	0.17	1.23	1.21	1.21	0.21	2.06	
		17	0.32	0.32	0.05	0.23	0.54	0.54	0.09	0.39	0.77	0.77	0.13	0.63	0.98	0.98	0.17	1.23	1.22	1.22	0.21	2.07	
		19	-	-	-	-	0.54	0.54	0.09	0.39	0.77	0.77	0.13	0.63	0.99	0.99	0.17	1.24	1.22	1.22	0.21	2.08	
		20	-	-	-	-	0.56	0.55	0.10	0.39	0.77	0.77	0.13	0.64	0.99	0.99	0.17	1.24	1.22	1.22	0.21	2.08	
6		15	0.21	0.21	0.03	0.12	0.43	0.43	0.06	0.25	0.65	0.65	0.09	0.38	0.87	0.87	0.12	0.56	1.09	1.09	0.16	1.00	
		17	0.21	0.21	0.03	0.12	0.43	0.43	0.06	0.25	0.65	0.65	0.09	0.38	0.87	0.87	0.13	0.57	1.09	1.09	0.16	1.00	
		19	-	-	-	-	0.43	0.43	0.06	0.25	0.65	0.65	0.09	0.38	0.88	0.88	0.13	0.57	1.09	1.09	0.16	1.01	
		20	-	-	-	-	0.43	0.43	0.06	0.25	0.65	0.65	0.09	0.38	0.88	0.88	0.13	0.57	1.09	1.09	0.16	1.01	
15		3	15	0.33	0.33	0.09	0.38	0.55	0.55	0.16	1.02	0.79	0.79	0.22	2.37	1.03	1.03	0.29	3.71	1.26	1.26	0.36	5.27
			17	0.33	0.33	0.09	0.38	0.55	0.55	0.16	1.03	0.79	0.79	0.23	2.38	1.03	1.03	0.29	3.72	1.26	1.26	0.36	5.29
			19	-	-	-	-	0.55	0.55	0.16	1.03	0.79	0.79	0.23	2.38	1.03	1.03	0.29	3.74	1.27	1.27	0.36	5.31
			20	-	-	-	-	0.57	0.55	0.16	1.14	0.79	0.79	0.23	2.39	1.03	1.03	0.29	3.74	1.27	1.27	0.36	5.32
		4	15	0.21	0.21	0.05	0.18	0.44	0.44	0.09	0.37	0.66	0.66	0.14	0.78	0.88	0.88	0.19	1.69	1.12	1.12	0.24	2.65
			17	0.21	0.21	0.05	0.18	0.44	0.44	0.09	0.38	0.66	0.66	0.14	0.78	0.89	0.89	0.19	1.70	1.13	1.13	0.24	2.66
			19	-	-	-	-	0.44	0.44	0.09	0.38	0.66	0.66	0.14	0.78	0.89	0.89	0.19	1.71	1.13	1.13	0.24	2.67
			20	-	-	-	-	0.44	0.44	0.09	0.38	0.66	0.66	0.14	0.79	0.89	0.89	0.19	1.71	1.13	1.13	0.24	2.67
	5	15	0.10	0.10	0.02	0.07	0.32	0.32	0.06	0.22	0.55	0.55	0.09	0.37	0.77	0.77	0.13	0.66	0.99	0.99	0.17	1.30	
		17	0.10	0.10	0.02	0.07	0.32	0.32	0.06	0.22	0.55	0.55	0.09	0.37	0.77	0.77	0.13	0.66	0.99	0.99	0.17	1.31	
		19	-	-	-	-	0.32	0.32	0.06	0.22	0.55	0.55	0.09	0.37	0.77	0.77	0.13	0.67	0.99	0.99	0.17	1.31	
		20	-	-	-	-	0.32	0.32	0.06	0.22	0.55	0.55	0.09	0.37	0.77	0.77	0.13	0.67	0.99	0.99	0.17	1.32	
	6	15	-	-	-	-	0.21	0.21	0.03	0.12	0.43	0.43	0.06	0.24	0.65	0.65	0.09	0.36	0.87	0.87	0.13	0.58	
		17	-	-	-	-	0.21	0.21	0.03	0.12	0.43	0.43	0.06	0.24	0.65	0.65	0.09	0.36	0.87	0.87	0.13	0.58	
		19	-	-	-	-	0.21	0.21	0.03	0.12	0.43	0.43	0.06	0.24	0.66	0.66	0.09	0.36	0.88	0.88	0.13	0.59	
		20	-	-	-	-	0.21	0.21	0.03	0.12	0.43	0.43	0.06	0.24	0.66	0.66	0.09	0.37	0.88	0.88	0.13	0.59	

EWT: Enter Water Temp. (°C) Δt: Temperature Difference (°C) DB: Dry Bulb Temp. (°C) WB: Wet Bulb Temp. (°C)
 TC: Total Cooling Capacity (kW) SC: Sensible Cooling Capacity (kW) WF: Water Flow (m³/h) WPD: Water Pressure Drop (kPa)

Cooling capacity

MDVF-300D302E																						
EWT	ΔT	Indoor temp (W.B.)	Indoor temperature (D.B.)																			
			21				23				25				27				29			
			TC	SC	WF	WPD	TC	SC	WF	WPD	TC	SC	WF	WPD	TC	SC	WF	WPD	TC	SC	WF	WPD
°C	°C	°C	kW	kW	m ³ /h	kPa	kW	kW	m ³ /h	kPa	kW	kW	m ³ /h	kPa	kW	kW	m ³ /h	kPa	kW	kW	m ³ /h	kPa
5	3	15	2.55	2.04	0.73	23.02	2.52	2.36	0.73	22.63	2.67	2.67	0.77	24.99	2.98	2.98	0.85	29.82	3.28	3.28	0.94	35.38
		17	3.47	2.04	0.99	38.91	3.45	2.36	0.99	38.47	3.43	2.67	0.98	38.06	3.40	2.98	0.97	37.61	3.37	3.29	0.96	37.05
		19	-	-	-	-	4.44	2.36	1.27	60.03	4.42	2.68	1.27	59.41	4.39	2.99	1.26	58.79	4.37	3.30	1.25	58.19
		20	-	-	-	-	4.98	2.37	1.44	74.37	4.95	2.68	1.43	73.60	4.92	3.00	1.42	72.85	4.89	3.30	1.41	72.12
	4	15	2.11	1.85	0.45	10.01	2.16	2.15	0.46	10.39	2.48	2.48	0.53	13.19	2.80	2.80	0.60	16.34	3.10	3.10	0.67	19.56
		17	3.06	1.86	0.66	19.09	3.04	2.18	0.66	18.88	3.02	2.49	0.65	18.66	2.99	2.80	0.64	18.36	3.11	3.11	0.67	19.62
		19	-	-	-	-	4.03	2.18	0.86	30.45	4.01	2.49	0.86	30.13	3.98	2.80	0.85	29.80	3.96	3.11	0.85	29.48
		20	-	-	-	-	4.56	2.18	0.98	37.75	4.53	2.49	0.97	37.35	4.50	2.81	0.97	36.96	4.48	3.12	0.96	36.58
	5	15	1.67	1.65	0.29	4.59	1.98	1.98	0.34	6.08	2.29	2.29	0.39	7.84	2.61	2.61	0.45	9.75	2.92	2.92	0.50	11.82
		17	2.62	1.67	0.45	9.84	2.60	1.99	0.45	9.71	2.58	2.30	0.44	9.55	2.61	2.60	0.45	9.74	2.92	2.92	0.50	11.86
		19	-	-	-	-	3.61	1.99	0.62	17.19	3.59	2.31	0.62	17.01	3.57	2.62	0.61	16.82	3.55	2.93	0.61	16.63
		20	-	-	-	-	4.13	1.99	0.71	21.51	4.11	2.31	0.70	21.29	4.08	2.62	0.70	21.06	4.06	2.93	0.70	20.85
6	15	1.46	1.46	0.21	2.26	1.78	1.78	0.25	3.65	2.10	2.10	0.30	4.95	2.42	2.42	0.35	6.30	2.74	2.74	0.39	7.74	
	17	2.16	1.47	0.31	5.17	2.13	1.79	0.31	5.07	2.13	2.11	0.30	5.06	2.43	2.43	0.35	6.31	2.74	2.74	0.39	7.76	
	19	-	-	-	-	3.17	1.81	0.45	9.93	3.14	2.12	0.45	9.81	3.12	2.44	0.45	9.69	3.09	2.75	0.44	9.54	
	20	-	-	-	-	3.70	1.81	0.53	13.02	3.68	2.13	0.53	12.88	3.66	2.44	0.52	12.74	3.63	2.75	0.52	12.59	
7	3	15	1.82	1.72	0.52	12.62	2.04	2.04	0.59	15.59	2.36	2.36	0.68	19.94	2.67	2.67	0.76	24.36	2.98	2.98	0.86	29.91
		17	2.76	1.72	0.79	25.83	2.74	2.04	0.79	25.52	2.71	2.36	0.78	25.13	2.70	2.67	0.77	24.91	2.98	2.98	0.86	29.99
		19	-	-	-	-	3.73	2.05	1.07	43.85	3.71	2.36	1.07	43.36	3.69	2.67	1.06	42.87	3.66	2.98	1.05	42.39
		20	-	-	-	-	4.26	2.05	1.23	55.32	4.24	2.36	1.22	54.73	4.21	2.68	1.21	54.16	4.18	2.99	1.20	53.57
	4	15	1.53	1.53	0.33	5.75	1.86	1.86	0.40	7.96	2.17	2.17	0.47	10.42	2.49	2.49	0.54	13.20	2.80	2.80	0.60	16.15
		17	2.33	1.54	0.50	11.78	2.31	1.86	0.50	11.59	2.28	2.18	0.49	11.33	2.49	2.49	0.54	13.24	2.80	2.80	0.61	16.20
		19	-	-	-	-	3.30	1.86	0.71	21.30	3.28	2.18	0.70	21.06	3.26	2.49	0.70	20.82	3.23	2.80	0.69	20.52
		20	-	-	-	-	3.83	1.86	0.82	27.57	3.80	2.18	0.82	27.26	3.78	2.50	0.81	26.96	3.76	2.81	0.81	26.67
	5	15	1.33	1.33	0.23	2.93	1.66	1.66	0.29	4.48	1.98	1.98	0.34	6.05	2.30	2.30	0.40	7.78	2.61	2.61	0.45	9.66
		17	1.85	1.35	0.32	5.35	1.83	1.67	0.31	5.24	1.99	1.98	0.34	6.06	2.30	2.30	0.40	7.80	2.62	2.62	0.45	9.69
		19	-	-	-	-	2.85	1.68	0.49	11.21	2.83	2.00	0.49	11.07	2.82	2.28	0.51	19.82	2.78	2.62	0.48	10.75
		20	-	-	-	-	3.38	1.68	0.58	15.07	3.36	2.00	0.58	14.89	3.34	2.31	0.57	14.71	3.31	2.63	0.57	14.52
6	15	1.17	1.17	0.17	1.32	1.47	1.47	0.21	2.42	1.79	1.79	0.26	3.73	2.11	2.11	0.30	4.91	2.43	2.43	0.35	6.22	
	17	1.35	1.16	0.19	1.94	1.47	1.46	0.21	2.42	1.80	1.80	0.26	3.74	2.12	2.12	0.30	4.92	2.43	2.43	0.35	6.24	
	19	-	-	-	-	2.37	1.49	0.34	5.96	2.34	1.81	0.34	5.85	2.32	2.12	0.33	5.75	2.43	2.42	0.35	6.24	
	20	-	-	-	-	2.91	1.50	0.42	8.46	2.89	1.82	0.41	8.35	2.87	2.13	0.41	8.24	2.84	2.44	0.41	8.10	
9	3	15	1.40	1.40	0.40	7.97	1.72	1.72	0.49	11.33	2.04	2.04	0.59	15.20	2.35	2.35	0.68	19.36	2.66	2.66	0.76	24.00
		17	1.99	1.41	0.57	14.57	1.97	1.73	0.57	14.25	2.04	2.02	0.59	15.14	2.36	2.36	0.68	19.41	2.67	2.67	0.77	24.07
		19	-	-	-	-	2.98	1.73	0.86	29.62	2.96	2.05	0.86	29.26	2.94	2.36	0.85	28.88	2.91	2.68	0.84	28.39
		20	-	-	-	-	3.50	1.73	1.01	38.69	3.48	2.05	1.00	38.23	3.46	2.36	0.99	37.80	3.43	2.67	0.99	37.37
	4	15	1.21	1.21	0.26	3.83	1.54	1.54	0.33	5.66	1.86	1.86	0.40	7.82	2.17	2.17	0.47	10.23	2.48	2.48	0.53	12.87
		17	1.51	1.22	0.32	5.47	1.54	1.53	0.33	5.68	1.86	1.86	0.40	7.84	2.18	2.18	0.47	10.26	2.49	2.49	0.54	12.91
		19	-	-	-	-	2.53	1.55	0.55	13.36	2.49	1.86	0.54	12.96	2.47	2.18	0.53	12.72	2.50	2.50	0.54	13.15
		20	-	-	-	-	3.05	1.55	0.66	18.40	3.03	1.87	0.65	18.18	3.01	2.18	0.65	17.95	2.98	2.50	0.64	17.66
	5	15	1.03	1.03	0.18	1.55	1.34	1.34	0.23	3.02	1.67	1.67	0.29	4.44	1.99	1.99	0.34	5.98	2.30	2.30	0.40	7.68
		17	1.04	1.03	0.18	1.60	1.35	1.35	0.23	3.03	1.67	1.67	0.29	4.46	1.99	1.99	0.34	6.00	2.31	2.31	0.40	7.70
		19	-	-	-	-	2.03	1.36	0.35	6.16	2.00	1.68	0.34	6.02	2.02	2.00	0.35	6.12	2.31	2.31	0.40	7.73
		20	-	-	-	-	2.57	1.37	0.44	9.23	2.54	1.69	0.44	9.10	2.52	2.00	0.43	8.94	2.50	2.31	0.43	8.81
6	15	0.89	0.89	0.13	0.70	1.17	1.17	0.17	1.37	1.48	1.48	0.21	2.50	1.80	1.80	0.26	3.69	2.12	2.12	0.30	4.87	
	17	0.89	0.88	0.13	0.70	1.18	1.18	0.17	1.37	1.48	1.48	0.21	2.50	1.80	1.80	0.26	3.70	2.13	2.13	0.30	4.88	
	19	-	-	-	-	1.47	1.16	0.21	2.46	1.49	1.49	0.21	2.56	1.81	1.81	0.26	3.72	2.13	2.13	0.31	4.90	
	20	-	-	-	-	2.05	1.18	0.29	4.59	2.02	1.50	0.29	4.49	2.00	1.81	0.29	4.41	2.13	2.12	0.31	4.89	

Continued:

MDVF-300D302E																						
EWT	ΔT	Indoor temp (W.B.)	Indoor temperature (D.B.)																			
			21				23				25				27				29			
			TC	SC	WF	WPD	TC	SC	WF	WPD	TC	SC	WF	WPD	TC	SC	WF	WPD	TC	SC	WF	WPD
°C	°C	°C	kW	kW	m³/h	kPa	kW	kW	m³/h	kPa	kW	kW	m³/h	kPa	kW	kW	m³/h	kPa	kW	kW	m³/h	kPa
11	3	15	1.08	1.08	0.31	4.97	1.40	1.40	0.40	7.76	1.72	1.72	0.49	11.02	2.04	2.04	0.58	14.83	2.35	2.35	0.67	18.83
		17	1.16	1.08	0.33	5.60	1.41	1.41	0.40	7.78	1.73	1.73	0.49	11.05	2.04	2.04	0.58	14.87	2.35	2.35	0.67	18.89
		19	-	-	-	-	2.16	1.41	0.62	16.23	2.13	1.73	0.61	15.90	2.12	2.04	0.60	15.74	2.36	2.36	0.67	18.95
		20	-	-	-	-	2.69	1.41	0.77	23.76	2.67	1.73	0.76	23.46	2.64	2.05	0.75	23.10	2.62	2.36	0.75	22.68
	4	15	0.89	0.89	0.19	1.93	1.22	1.22	0.26	3.72	1.54	1.54	0.33	5.55	1.86	1.86	0.40	7.65	2.17	2.17	0.47	9.99
		17	0.89	0.89	0.19	1.94	1.22	1.22	0.26	3.73	1.54	1.54	0.33	5.57	1.86	1.86	0.40	7.67	2.18	2.18	0.47	10.02
		19	-	-	-	-	1.65	1.23	0.35	6.25	1.64	1.55	0.35	6.19	1.86	1.86	0.40	7.69	2.18	2.18	0.47	10.05
		20	-	-	-	-	2.20	1.23	0.47	10.18	2.17	1.55	0.47	10.00	2.15	1.87	0.46	9.80	2.19	2.19	0.47	10.12
	5	15	0.75	0.75	0.13	0.71	1.04	1.04	0.18	1.64	1.35	1.35	0.23	3.06	1.68	1.68	0.29	4.41	2.00	2.00	0.34	5.92
		17	0.75	0.75	0.13	0.71	1.04	1.04	0.18	1.64	1.36	1.36	0.23	3.07	1.68	1.68	0.29	4.43	2.00	2.00	0.34	5.94
		19	-	-	-	-	1.11	1.03	0.19	1.99	1.36	1.35	0.23	3.08	1.69	1.69	0.29	4.44	2.00	2.00	0.34	5.96
		20	-	-	-	-	1.67	1.05	0.29	4.38	1.65	1.37	0.28	4.28	1.70	1.69	0.29	4.49	2.01	2.01	0.35	5.97
6	15	0.59	0.59	0.08	0.43	0.89	0.89	0.13	0.70	1.18	1.18	0.17	1.44	1.49	1.49	0.21	2.58	1.81	1.81	0.26	3.67	
	17	0.59	0.59	0.08	0.43	0.89	0.89	0.13	0.70	1.18	1.18	0.17	1.44	1.49	1.49	0.21	2.59	1.82	1.82	0.26	3.68	
	19	-	-	-	-	0.89	0.88	0.13	0.70	1.18	1.18	0.17	1.45	1.49	1.49	0.21	2.60	1.82	1.82	0.26	3.69	
	20	-	-	-	-	1.13	0.86	0.16	1.28	1.19	1.18	0.17	1.47	1.50	1.50	0.21	2.60	1.82	1.82	0.26	3.70	
13	3	15	0.76	0.76	0.22	2.68	1.09	1.09	0.31	5.00	1.41	1.41	0.40	7.78	1.72	1.72	0.50	11.02	2.03	2.03	0.58	14.48
		17	0.76	0.76	0.22	2.69	1.09	1.09	0.31	5.01	1.41	1.41	0.41	7.80	1.73	1.73	0.50	11.05	2.04	2.04	0.59	14.81
		19	-	-	-	-	1.27	1.09	0.36	6.52	1.41	1.39	0.40	7.77	1.73	1.73	0.50	11.09	2.04	2.04	0.58	14.57
		20	-	-	-	-	1.81	1.09	0.52	11.97	1.78	1.41	0.51	11.68	1.79	1.73	0.51	11.70	2.04	2.04	0.58	14.59
	4	15	0.60	0.60	0.13	0.71	0.90	0.90	0.19	2.05	1.22	1.22	0.26	3.73	1.54	1.54	0.33	5.48	1.86	1.86	0.40	7.54
		17	0.60	0.60	0.13	0.71	0.90	0.90	0.19	2.06	1.23	1.23	0.26	3.75	1.55	1.55	0.33	5.50	1.86	1.86	0.40	7.56
		19	-	-	-	-	0.89	0.88	0.19	2.04	1.23	1.23	0.26	3.76	1.55	1.55	0.33	5.51	1.87	1.87	0.40	7.58
		20	-	-	-	-	1.26	0.91	0.27	3.92	1.27	1.23	0.27	3.98	1.55	1.55	0.33	5.52	1.87	1.87	0.40	7.60
	5	15	0.44	0.44	0.08	0.37	0.74	0.74	0.13	0.70	1.04	1.04	0.18	1.68	1.36	1.36	0.23	3.02	1.68	1.68	0.29	4.32
		17	0.44	0.44	0.08	0.37	0.75	0.75	0.13	0.70	1.04	1.04	0.18	1.69	1.36	1.36	0.23	3.03	1.68	1.68	0.29	4.34
		19	-	-	-	-	0.75	0.75	0.13	0.70	1.04	1.04	0.18	1.70	1.36	1.36	0.23	3.04	1.69	1.69	0.29	4.35
		20	-	-	-	-	0.78	0.74	0.13	0.79	1.04	1.04	0.18	1.70	1.37	1.37	0.23	3.04	1.69	1.69	0.29	4.36
6	15	0.29	0.29	0.04	0.20	0.59	0.59	0.08	0.41	0.89	0.89	0.13	0.70	1.18	1.18	0.17	1.48	1.50	1.50	0.21	2.58	
	17	0.29	0.29	0.04	0.20	0.59	0.59	0.08	0.41	0.89	0.89	0.13	0.71	1.18	1.18	0.17	1.49	1.50	1.50	0.21	2.59	
	19	-	-	-	-	0.59	0.59	0.08	0.41	0.90	0.90	0.13	0.71	1.18	1.18	0.17	1.50	1.50	1.50	0.21	2.60	
	20	-	-	-	-	0.59	0.58	0.08	0.41	0.90	0.90	0.13	0.71	1.18	1.18	0.17	1.50	1.50	1.50	0.21	2.60	
15	3	15	0.45	0.45	0.13	0.71	0.76	0.76	0.22	2.64	1.09	1.09	0.31	4.86	1.41	1.41	0.40	7.55	1.72	1.72	0.49	10.70
		17	0.45	0.45	0.13	0.71	0.76	0.76	0.22	2.64	1.09	1.09	0.31	4.87	1.41	1.41	0.40	7.58	1.72	1.72	0.49	10.73
		19	-	-	-	-	0.76	0.76	0.22	2.65	1.09	1.09	0.31	4.89	1.41	1.41	0.40	7.60	1.73	1.73	0.49	10.77
		20	-	-	-	-	0.83	0.76	0.24	3.10	1.09	1.08	0.31	4.89	1.41	1.41	0.40	7.61	1.73	1.73	0.49	10.78
	4	15	0.29	0.29	0.06	0.30	0.60	0.60	0.13	0.71	0.90	0.90	0.19	2.09	1.23	1.23	0.26	3.66	1.55	1.55	0.33	5.42
		17	0.30	0.30	0.06	0.30	0.60	0.60	0.13	0.72	0.90	0.90	0.19	2.09	1.23	1.23	0.26	3.67	1.55	1.55	0.33	5.44
		19	-	-	-	-	0.60	0.60	0.13	0.72	0.90	0.90	0.19	2.10	1.23	1.23	0.26	3.68	1.55	1.55	0.33	5.46
		20	-	-	-	-	0.60	0.59	0.13	0.72	0.90	0.90	0.19	2.11	1.23	1.23	0.26	3.69	1.55	1.55	0.33	5.47
	5	15	0.15	0.15	0.03	0.12	0.45	0.45	0.08	0.36	0.75	0.75	0.13	0.73	1.04	1.04	0.18	1.78	1.37	1.37	0.24	3.03
		17	0.15	0.15	0.03	0.12	0.45	0.45	0.08	0.36	0.75	0.75	0.13	0.73	1.04	1.04	0.18	1.79	1.37	1.37	0.24	3.04
		19	-	-	-	-	0.45	0.45	0.08	0.36	0.75	0.75	0.13	0.74	1.05	1.05	0.18	1.80	1.37	1.37	0.24	3.05
		20	-	-	-	-	0.45	0.45	0.08	0.36	0.75	0.75	0.13	0.74	1.05	1.05	0.18	1.80	1.37	1.37	0.24	3.05
6	15	-	-	-	-	0.29	0.29	0.04	0.19	0.60	0.60	0.09	0.39	0.89	0.89	0.13	0.73	1.18	1.18	0.17	1.57	
	17	-	-	-	-	0.29	0.29	0.04	0.19	0.60	0.60	0.09	0.39	0.89	0.89	0.13	0.74	1.19	1.19	0.17	1.57	
	19	-	-	-	-	0.29	0.29	0.04	0.19	0.60	0.60	0.09	0.40	0.90	0.90	0.13	0.74	1.19	1.19	0.17	1.58	
	20	-	-	-	-	0.30	0.30	0.04	0.19	0.60	0.60	0.09	0.40	0.90	0.90	0.13	0.74	1.19	1.19	0.17	1.58	

EWT: Enter Water Temp. (°C) Δt: Temperature Difference (°C) DB: Dry Bulb Temp. (°C) WB: Wet Bulb Temp. (°C)
 TC: Total Cooling Capacity (kW) SC: Sensible Cooling Capacity (kW) WF: Water Flow (m³/h) WPD: Water Pressure Drop (kPa)

Cooling capacity

MDVF-400D302E																						
EWT	ΔT	Indoor temp (W.B.)	Indoor temperature (D.B.)																			
			21				23				25				27				29			
			TC	SC	WF	WPD	TC	SC	WF	WPD	TC	SC	WF	WPD	TC	SC	WF	WPD	TC	SC	WF	WPD
°C	°C	°C	kW	kW	m³/h	kPa	kW	kW	m³/h	kPa	kW	kW	m³/h	kPa	kW	kW	m³/h	kPa	kW	kW	m³/h	kPa
5	3	15	2.89	2.32	0.83	32.80	2.86	2.68	0.82	32.28	3.04	3.04	0.87	35.84	3.39	3.39	0.97	43.44	3.74	3.74	1.07	51.61
		17	3.94	2.32	1.13	56.42	3.92	2.68	1.12	55.86	3.89	3.04	1.12	55.29	3.87	3.40	1.11	54.74	3.85	3.75	1.10	54.07
		19	-	-	-	-	5.05	2.68	1.45	87.45	5.02	3.04	1.44	86.64	5.00	3.40	1.43	85.80	4.97	3.76	1.43	85.00
		20	-	-	-	-	5.66	2.69	1.64	108.60	5.64	3.05	1.63	107.63	5.61	3.41	1.62	106.65	5.58	3.76	1.62	105.65
	4	15	2.40	2.10	0.51	14.46	2.47	2.47	0.53	15.17	2.83	2.83	0.61	19.35	3.18	3.18	0.68	23.46	3.54	3.54	0.76	28.15
		17	3.46	2.10	0.74	27.17	3.44	2.47	0.74	26.90	3.42	2.83	0.73	26.63	3.39	3.19	0.73	26.23	3.54	3.54	0.76	28.21
		19	-	-	-	-	4.58	2.47	0.98	44.20	4.56	2.83	0.98	43.77	4.53	3.19	0.97	43.34	4.50	3.55	0.97	42.90
		20	-	-	-	-	5.19	2.47	1.12	55.18	5.16	2.84	1.11	54.67	5.13	3.20	1.11	54.15	5.10	3.55	1.10	53.64
	5	15	1.92	1.88	0.33	6.70	2.25	2.25	0.39	8.80	2.61	2.61	0.45	11.36	2.97	2.97	0.51	14.16	3.33	3.33	0.57	17.35
		17	2.98	1.89	0.51	14.19	2.96	2.26	0.51	14.03	2.93	2.62	0.50	13.80	2.99	2.98	0.51	14.33	3.34	3.34	0.57	17.40
		19	-	-	-	-	4.09	2.26	0.70	24.56	4.07	2.62	0.70	24.31	4.05	2.98	0.69	24.07	4.02	3.34	0.69	23.82
		20	-	-	-	-	4.71	2.27	0.81	31.49	4.68	2.63	0.81	31.20	4.65	2.99	0.80	30.89	4.63	3.34	0.80	30.59
6	15	1.65	1.65	0.24	3.59	2.03	2.03	0.29	5.41	2.40	2.40	0.34	7.19	2.76	2.76	0.40	9.14	3.12	3.12	0.45	11.25	
	17	2.46	1.67	0.35	7.47	2.43	2.04	0.35	7.33	2.46	2.41	0.35	7.47	2.77	2.77	0.40	9.16	3.13	3.13	0.45	11.28	
	19	-	-	-	-	3.60	2.05	0.52	14.41	3.58	2.42	0.51	14.25	3.56	2.78	0.51	14.10	3.53	3.13	0.51	13.89	
	20	-	-	-	-	4.20	2.05	0.60	18.61	4.17	2.42	0.60	18.42	4.15	2.78	0.59	18.24	4.12	3.13	0.59	18.05	
7	3	15	2.08	1.96	0.60	18.65	2.32	2.32	0.67	22.25	2.69	2.69	0.78	29.01	3.04	3.04	0.88	36.02	3.39	3.39	0.97	43.02
		17	3.14	1.96	0.91	38.06	3.12	2.33	0.90	37.67	3.10	2.69	0.90	37.14	3.09	3.05	0.89	37.04	3.40	3.40	0.98	43.13
		19	-	-	-	-	4.25	2.32	1.22	63.82	4.22	2.69	1.22	63.38	4.20	3.05	1.21	63.07	4.18	3.40	1.21	62.45
		20	-	-	-	-	4.86	2.33	1.41	82.02	4.82	2.69	1.39	79.89	4.79	3.05	1.38	79.10	4.77	3.40	1.37	78.32
	4	15	1.74	1.74	0.38	8.31	2.11	2.11	0.46	11.60	2.48	2.48	0.54	15.20	2.83	2.83	0.61	18.97	3.19	3.19	0.69	23.27
		17	2.63	1.75	0.57	16.72	2.61	2.11	0.56	16.55	2.60	2.48	0.56	16.58	2.83	2.83	0.61	19.01	3.19	3.19	0.69	23.32
		19	-	-	-	-	3.76	2.12	0.81	31.30	3.74	2.48	0.81	30.98	3.72	2.84	0.80	30.65	3.69	3.20	0.80	30.26
		20	-	-	-	-	4.36	2.12	0.94	40.51	4.34	2.48	0.94	40.11	4.30	2.84	0.93	39.15	4.27	3.20	0.92	38.76
	5	15	1.52	1.52	0.26	4.45	1.90	1.90	0.33	6.49	2.26	2.26	0.39	8.77	2.62	2.62	0.45	11.29	2.98	2.98	0.51	14.05
		17	2.10	1.53	0.36	7.72	2.08	1.90	0.36	7.60	2.26	2.26	0.39	8.78	2.63	2.63	0.45	11.32	2.99	2.99	0.51	14.09
		19	-	-	-	-	3.24	1.91	0.56	16.28	3.22	2.27	0.56	16.10	3.20	2.64	0.58	25.96	3.17	2.99	0.55	15.71
		20	-	-	-	-	3.84	1.91	0.66	21.73	3.82	2.27	0.66	21.50	3.79	2.63	0.65	21.27	3.77	2.99	0.65	21.03
6	15	1.32	1.32	0.19	2.09	1.67	1.67	0.24	3.78	2.05	2.05	0.29	5.39	2.41	2.41	0.35	7.13	2.77	2.77	0.40	9.05	
	17	1.51	1.30	0.22	2.97	1.67	1.67	0.24	3.79	2.05	2.05	0.29	5.40	2.42	2.42	0.35	7.15	2.78	2.78	0.40	9.07	
	19	-	-	-	-	2.70	1.69	0.39	8.61	2.67	2.06	0.38	8.47	2.65	2.42	0.38	8.36	2.79	2.79	0.40	9.15	
	20	-	-	-	-	3.31	1.70	0.47	12.21	3.29	2.06	0.47	12.08	3.26	2.43	0.47	11.93	3.23	2.78	0.46	11.74	
9	3	15	1.60	1.60	0.46	11.53	1.96	1.96	0.57	16.54	2.32	2.32	0.67	21.98	2.69	2.69	0.78	28.63	3.04	3.04	0.87	35.01
		17	2.27	1.60	0.65	21.03	2.24	1.96	0.64	20.60	2.33	2.32	0.67	22.04	2.69	2.69	0.78	28.70	3.04	3.04	0.87	35.10
		19	-	-	-	-	3.39	1.97	0.98	43.02	3.36	2.33	0.96	41.48	3.35	2.69	0.97	42.06	3.31	3.04	0.95	40.61
		20	-	-	-	-	3.98	1.96	1.15	56.24	3.96	2.33	1.14	55.65	3.93	2.69	1.13	55.07	3.91	3.05	1.13	54.51
	4	15	1.38	1.38	0.30	5.47	1.75	1.75	0.38	8.21	2.12	2.12	0.46	11.35	2.48	2.48	0.53	14.87	2.84	2.84	0.61	18.85
		17	1.72	1.38	0.37	7.93	1.78	1.76	0.38	8.40	2.12	2.12	0.46	11.38	2.48	2.48	0.53	14.91	2.84	2.84	0.61	18.90
		19	-	-	-	-	2.86	1.76	0.62	19.16	2.84	2.12	0.61	18.92	2.81	2.48	0.61	18.59	2.87	2.85	0.62	19.26
		20	-	-	-	-	3.47	1.76	0.75	26.82	3.44	2.13	0.75	26.52	3.42	2.49	0.74	26.23	3.40	2.85	0.74	25.86
	5	15	1.16	1.16	0.20	2.47	1.53	1.53	0.26	4.46	1.91	1.91	0.33	6.45	2.27	2.27	0.39	8.69	2.63	2.63	0.45	11.18
		17	1.18	1.16	0.20	2.57	1.54	1.54	0.26	4.47	1.91	1.91	0.33	6.47	2.27	2.27	0.39	8.72	2.63	2.63	0.45	11.21
		19	-	-	-	-	2.31	1.55	0.40	8.92	2.28	1.91	0.39	8.73	2.33	2.28	0.40	9.08	2.64	2.64	0.45	11.24
		20	-	-	-	-	2.92	1.55	0.50	13.34	2.90	1.92	0.50	13.17	2.87	2.28	0.49	12.96	2.85	2.64	0.49	12.83
6	15	1.00	1.00	0.14	1.03	1.32	1.32	0.19	2.18	1.69	1.69	0.24	3.81	2.06	2.06	0.30	5.37	2.43	2.43	0.35	7.09	
	17	1.00	0.99	0.14	1.03	1.32	1.32	0.19	2.19	1.69	1.69	0.24	3.82	2.06	2.06	0.30	5.39	2.43	2.43	0.35	7.10	
	19	-	-	-	-	1.67	1.32	0.24	3.75	1.74	1.70	0.25	4.01	2.07	2.06	0.30	5.40	2.43	2.43	0.35	7.12	
	20	-	-	-	-	2.33	1.34	0.33	6.64	2.31	1.70	0.33	6.51	2.29	2.07	0.33	6.43	2.45	2.44	0.35	7.21	

Continued:

MDVF-400D302E																							
EWT	ΔT	Indoor temp (W.B.)	Indoor temperature (D.B.)																				
			21				23				25				27				29				
			TC	SC	WF	WPD	TC	SC	WF	WPD	TC	SC	WF	WPD	TC	SC	WF	WPD	TC	SC	WF	WPD	
°C	°C	°C	kW	kW	m³/h	kPa	kW	kW	m³/h	kPa	kW	kW	m³/h	kPa	kW	kW	m³/h	kPa	kW	kW	m³/h	kPa	
11	3	15	1.23	1.23	0.35	7.19	1.60	1.60	0.46	11.26	1.96	1.96	0.56	16.01	2.32	2.32	0.66	21.44	2.68	2.68	0.77	27.61	
		17	1.33	1.23	0.38	8.15	1.60	1.60	0.46	11.28	1.97	1.97	0.56	16.05	2.33	2.33	0.66	21.50	2.69	2.69	0.77	27.70	
		19	-	-	-	-	2.45	1.60	0.70	23.57	2.43	1.97	0.69	23.12	2.42	2.33	0.69	23.03	2.69	2.69	0.77	27.78	
		20	-	-	-	-	3.06	1.60	0.88	34.78	3.04	1.97	0.87	34.36	3.01	2.33	0.86	33.91	2.98	2.69	0.85	33.00	
	4	15	1.01	1.01	0.22	3.05	1.39	1.39	0.30	5.40	1.76	1.76	0.38	8.07	2.12	2.12	0.45	11.12	2.48	2.48	0.53	14.55	
		17	1.01	1.01	0.22	3.05	1.39	1.39	0.30	5.42	1.76	1.76	0.38	8.09	2.12	2.12	0.45	11.15	2.48	2.48	0.53	14.59	
		19	-	-	-	-	1.88	1.39	0.40	9.05	1.88	1.76	0.40	9.04	2.13	2.12	0.46	11.16	2.49	2.49	0.53	14.63	
		20	-	-	-	-	2.50	1.40	0.54	14.73	2.48	1.76	0.53	14.50	2.45	2.13	0.52	14.22	2.52	2.49	0.54	14.97	
	5	15	0.84	0.84	0.14	1.07	1.17	1.17	0.20	2.61	1.55	1.55	0.27	4.47	1.92	1.92	0.33	6.42	2.28	2.28	0.39	8.63	
		17	0.84	0.84	0.14	1.07	1.17	1.17	0.20	2.62	1.55	1.55	0.27	4.48	1.92	1.92	0.33	6.44	2.28	2.28	0.39	8.65	
		19	-	-	-	-	1.27	1.17	0.22	3.12	1.55	1.54	0.27	4.48	1.92	1.92	0.33	6.46	2.29	2.29	0.39	8.67	
		20	-	-	-	-	1.91	1.19	0.33	6.35	1.88	1.56	0.32	6.21	1.97	1.93	0.34	6.71	2.29	2.29	0.39	8.68	
	6	15	0.67	0.67	0.10	0.57	1.00	1.00	0.14	1.07	1.33	1.33	0.19	2.30	1.70	1.70	0.24	3.84	2.07	2.07	0.30	5.30	
		17	0.67	0.67	0.10	0.57	1.00	1.00	0.14	1.07	1.33	1.33	0.19	2.31	1.71	1.71	0.24	3.85	2.07	2.07	0.30	5.32	
		19	-	-	-	-	1.01	1.01	0.14	1.09	1.34	1.34	0.19	2.32	1.71	1.71	0.25	3.86	2.08	2.08	0.30	5.33	
		20	-	-	-	-	1.24	0.97	0.18	1.93	1.36	1.34	0.19	2.40	1.71	1.71	0.25	3.86	2.08	2.08	0.30	5.34	
	13	3	15	0.87	0.87	0.25	3.94	1.24	1.24	0.36	7.25	1.61	1.61	0.46	11.30	1.97	1.97	0.57	16.05	2.33	2.33	0.67	21.46
			17	0.87	0.87	0.25	3.95	1.24	1.24	0.36	7.27	1.61	1.61	0.46	11.33	1.97	1.97	0.57	16.09	2.33	2.33	0.67	21.51
			19	-	-	-	-	1.45	1.24	0.42	9.45	1.61	1.60	0.46	11.34	1.97	1.97	0.57	16.14	2.33	2.33	0.67	21.57
			20	-	-	-	-	2.06	1.24	0.59	17.41	2.03	1.61	0.58	16.98	2.05	1.98	0.59	17.18	2.34	2.33	0.67	21.59
		4	15	0.67	0.67	0.14	1.10	1.02	1.02	0.22	3.18	1.39	1.39	0.30	5.36	1.76	1.76	0.38	7.98	2.12	2.12	0.46	10.99
			17	0.67	0.67	0.14	1.10	1.02	1.02	0.22	3.19	1.40	1.40	0.30	5.37	1.76	1.76	0.38	8.00	2.13	2.13	0.46	11.02
			19	-	-	-	-	1.02	1.01	0.22	3.17	1.40	1.40	0.30	5.38	1.77	1.77	0.38	8.02	2.13	2.13	0.46	11.05
			20	-	-	-	-	1.43	1.03	0.31	5.55	1.46	1.40	0.31	5.79	1.77	1.76	0.38	8.02	2.13	2.13	0.46	11.06
5		15	0.50	0.50	0.09	0.49	0.84	0.84	0.14	1.09	1.18	1.18	0.20	2.67	1.56	1.56	0.27	4.40	1.92	1.92	0.33	6.30	
		17	0.50	0.50	0.09	0.49	0.84	0.84	0.14	1.09	1.18	1.18	0.20	2.68	1.56	1.56	0.27	4.41	1.93	1.93	0.33	6.32	
		19	-	-	-	-	0.84	0.84	0.14	1.10	1.18	1.18	0.20	2.69	1.56	1.56	0.27	4.42	1.93	1.93	0.33	6.34	
		20	-	-	-	-	0.87	0.83	0.15	1.22	1.18	1.18	0.20	2.69	1.56	1.56	0.27	4.43	1.93	1.93	0.33	6.35	
6		15	0.33	0.33	0.05	0.26	0.67	0.67	0.10	0.54	1.00	1.00	0.14	1.10	1.34	1.34	0.19	2.37	1.71	1.71	0.25	3.79	
		17	0.33	0.33	0.05	0.26	0.67	0.67	0.10	0.54	1.00	1.00	0.14	1.11	1.34	1.34	0.19	2.38	1.72	1.72	0.25	3.80	
		19	-	-	-	-	0.67	0.67	0.10	0.54	1.00	1.00	0.14	1.11	1.34	1.34	0.19	2.39	1.72	1.72	0.25	3.82	
		20	-	-	-	-	0.67	0.66	0.10	0.54	1.01	1.01	0.14	1.11	1.34	1.34	0.19	2.39	1.72	1.72	0.25	3.82	
15		3	15	0.50	0.50	0.14	1.11	0.87	0.87	0.25	3.85	1.24	1.24	0.35	7.07	1.60	1.60	0.46	11.00	1.97	1.97	0.57	15.85
			17	0.50	0.50	0.14	1.11	0.87	0.87	0.25	3.86	1.24	1.24	0.35	7.08	1.61	1.61	0.46	11.03	1.97	1.97	0.57	15.90
			19	-	-	-	-	0.87	0.87	0.25	3.87	1.24	1.24	0.35	7.10	1.61	1.61	0.46	11.06	1.98	1.98	0.57	15.94
			20	-	-	-	-	0.96	0.87	0.27	4.55	1.24	1.23	0.35	7.09	1.61	1.61	0.46	11.07	1.98	1.98	0.57	15.96
		4	15	0.33	0.33	0.07	0.40	0.67	0.67	0.14	1.13	1.03	1.03	0.22	3.15	1.40	1.40	0.30	5.33	1.77	1.77	0.38	7.91
			17	0.33	0.33	0.07	0.40	0.67	0.67	0.14	1.13	1.03	1.03	0.22	3.16	1.40	1.40	0.30	5.34	1.77	1.77	0.38	7.93
			19	-	-	-	-	0.67	0.67	0.14	1.14	1.03	1.03	0.22	3.17	1.41	1.41	0.30	5.36	1.77	1.77	0.38	7.95
			20	-	-	-	-	0.67	0.66	0.14	1.13	1.03	1.03	0.22	3.17	1.41	1.41	0.30	5.37	1.77	1.77	0.38	7.96
	5	15	0.17	0.17	0.03	0.15	0.51	0.51	0.09	0.48	0.84	0.84	0.14	1.16	1.19	1.19	0.21	2.77	1.57	1.57	0.27	4.42	
		17	0.17	0.17	0.03	0.15	0.51	0.51	0.09	0.48	0.84	0.84	0.14	1.17	1.19	1.19	0.21	2.78	1.57	1.57	0.27	4.43	
		19	-	-	-	-	0.51	0.51	0.09	0.48	0.84	0.84	0.15	1.17	1.20	1.20	0.21	2.79	1.57	1.57	0.27	4.45	
		20	-	-	-	-	0.51	0.51	0.09	0.48	0.84	0.84	0.15	1.17	1.20	1.20	0.21	2.79	1.57	1.57	0.27	4.45	
	6	15	-	-	-	-	0.33	0.33	0.05	0.26	0.68	0.68	0.10	0.52	1.00	1.00	0.14	1.17	1.35	1.35	0.19	2.48	
		17	-	-	-	-	0.33	0.33	0.05	0.26	0.68	0.68	0.10	0.52	1.01	1.01	0.14	1.17	1.36	1.36	0.19	2.48	
		19	-	-	-	-	0.33	0.33	0.05	0.26	0.68	0.68	0.10	0.52	1.01	1.01	0.14	1.18	1.36	1.36	0.20	2.49	
		20	-	-	-	-	0.34	0.34	0.05	0.26	0.68	0.68	0.10	0.52	1.01	1.01	0.14	1.18	1.36	1.36	0.20	2.50	

EWT: Enter Water Temp. (°C) Δt: Temperature Difference (°C) DB: Dry Bulb Temp. (°C) WB: Wet Bulb Temp. (°C)
 TC: Total Cooling Capacity (kW) SC: Sensible Cooling Capacity (kW) WF: Water Flow (m³/h) WPD: Water Pressure Drop (kPa)

Cooling capacity

MDVF-500D302E																							
EWT	ΔT	Indoor temp (W.B.)	Indoor temperature (D.B.)																				
			21				23				25				27				29				
			TC	SC	WF	WPD	TC	SC	WF	WPD	TC	SC	WF	WPD	TC	SC	WF	WPD	TC	SC	WF	WPD	
°C	°C	°C	kW	kW	m³/h	kPa	kW	kW	m³/h	kPa	kW	kW	m³/h	kPa	kW	kW	m³/h	kPa	kW	kW	m³/h	kPa	
5	3	15	3.47	2.77	1.00	45.53	3.44	3.19	0.98	44.43	3.62	3.62	1.04	49.27	4.04	4.04	1.16	58.88	4.45	4.45	1.28	69.98	
		17	4.71	2.77	1.36	77.73	4.69	3.20	1.36	77.75	4.67	3.62	1.35	77.06	4.64	4.05	1.34	76.29	4.61	4.46	1.33	75.38	
		19	-	-	-	-	6.03	3.20	1.74	120.76	5.99	3.62	1.73	118.66	5.96	4.05	1.72	117.88	5.94	4.47	1.72	117.91	
		20	-	-	-	-	6.74	3.20	1.95	147.53	6.71	3.63	1.93	145.08	6.68	4.05	1.93	144.63	6.65	4.47	1.93	144.63	
	4	15	2.93	2.52	0.63	20.53	2.99	2.96	0.64	21.24	3.37	3.37	0.72	25.98	3.80	3.80	0.81	31.87	4.22	4.22	0.91	38.63	
		17	4.17	2.52	0.90	37.56	4.15	2.95	0.89	37.17	4.12	3.38	0.88	36.80	4.09	3.80	0.88	36.28	4.23	4.23	0.91	38.74	
		19	-	-	-	-	5.50	2.96	1.19	61.43	5.47	3.39	1.18	60.85	5.44	3.81	1.17	59.88	5.41	4.23	1.17	59.70	
		20	-	-	-	-	6.21	2.96	1.34	76.05	6.18	3.39	1.34	75.37	6.15	3.81	1.33	74.67	6.11	4.23	1.32	73.97	
	5	15	2.38	2.28	0.41	9.68	2.71	2.71	0.46	12.07	3.14	3.14	0.54	15.67	3.56	3.56	0.61	19.47	3.98	3.98	0.68	23.36	
		17	3.63	2.28	0.63	20.10	3.61	2.72	0.62	19.89	3.58	3.14	0.62	19.59	3.63	3.57	0.63	20.12	3.98	3.98	0.68	23.42	
		19	-	-	-	-	4.95	2.72	0.85	34.35	4.92	3.15	0.85	34.01	4.89	3.57	0.84	33.67	4.86	3.99	0.84	33.33	
		20	-	-	-	-	5.65	2.71	0.97	42.91	5.61	3.14	0.96	42.50	5.58	3.57	0.96	42.09	5.55	3.99	0.95	41.68	
	6	15	2.02	2.01	0.29	5.36	2.46	2.46	0.35	7.51	2.90	2.90	0.41	9.90	3.33	3.33	0.48	12.57	3.75	3.75	0.54	15.42	
		17	3.04	2.04	0.44	10.76	3.01	2.47	0.43	10.58	3.03	2.90	0.43	10.71	3.33	3.33	0.48	12.59	3.75	3.75	0.54	15.46	
		19	-	-	-	-	4.37	2.47	0.62	19.95	4.34	2.90	0.62	19.75	4.32	3.33	0.62	19.54	4.28	3.75	0.61	19.26	
		20	-	-	-	-	5.08	2.48	0.73	25.90	5.05	2.91	0.72	25.65	5.02	3.33	0.72	25.39	4.99	3.75	0.71	25.13	
	7	3	15	2.51	2.34	0.72	25.40	2.77	2.77	0.80	30.67	3.20	3.20	0.92	39.32	3.61	3.61	1.04	48.10	4.04	4.04	1.16	58.54
			17	3.76	2.34	1.08	51.88	3.74	2.77	1.08	51.41	3.71	3.20	1.07	50.23	3.70	3.62	1.06	50.12	4.04	4.04	1.16	58.63
			19	-	-	-	-	5.08	2.77	1.46	87.64	5.05	3.20	1.46	87.67	5.03	3.63	1.46	87.19	5.00	4.05	1.45	86.31
			20	-	-	-	-	5.79	2.78	1.68	111.42	5.77	3.21	1.68	111.24	5.72	3.63	1.65	108.39	5.69	4.05	1.64	107.31
		4	15	2.11	2.11	0.46	11.54	2.53	2.53	0.55	15.82	2.96	2.96	0.64	20.45	3.38	3.38	0.73	25.77	3.80	3.80	0.82	31.93
			17	3.19	2.10	0.69	23.32	3.17	2.53	0.68	23.00	3.15	2.96	0.68	22.77	3.38	3.38	0.73	25.82	3.81	3.81	0.82	32.01
			19	-	-	-	-	4.52	2.54	0.98	43.13	4.49	2.96	0.97	42.68	4.47	3.39	0.97	42.24	4.43	3.81	0.96	41.72
			20	-	-	-	-	5.23	2.53	1.13	55.63	5.20	2.97	1.13	55.09	5.17	3.39	1.12	54.53	5.14	3.81	1.11	54.00
5		15	1.85	1.85	0.32	6.23	2.29	2.29	0.39	8.94	2.72	2.72	0.47	12.00	3.15	3.15	0.54	15.45	3.56	3.56	0.61	19.12	
		17	2.60	1.86	0.45	11.08	2.57	2.29	0.44	10.90	2.74	2.73	0.47	12.15	3.15	3.15	0.54	15.50	3.57	3.57	0.61	19.16	
		19	-	-	-	-	3.93	2.29	0.68	22.58	3.90	2.72	0.67	22.33	3.90	3.10	0.70	34.31	3.85	3.57	0.66	21.82	
		20	-	-	-	-	4.65	2.30	0.80	30.48	4.62	2.73	0.80	30.17	4.59	3.16	0.79	29.85	4.57	3.58	0.79	29.54	
6		15	1.59	1.59	0.23	3.41	2.04	2.04	0.29	5.36	2.48	2.48	0.36	7.46	2.91	2.91	0.42	9.80	3.33	3.33	0.48	12.37	
		17	1.93	1.60	0.28	4.88	2.08	2.05	0.30	5.53	2.48	2.48	0.36	7.48	2.91	2.91	0.42	9.83	3.34	3.34	0.48	12.41	
		19	-	-	-	-	3.32	2.05	0.48	12.29	3.29	2.48	0.47	12.11	3.27	2.91	0.47	11.95	3.40	3.34	0.49	12.81	
		20	-	-	-	-	4.04	2.06	0.58	17.24	4.01	2.49	0.58	17.04	3.98	2.92	0.57	16.84	3.95	3.34	0.57	16.58	
9		3	15	1.91	1.91	0.55	15.83	2.34	2.34	0.67	22.30	2.77	2.77	0.80	30.29	3.19	3.19	0.92	38.21	3.62	3.62	1.05	48.16
			17	2.75	1.92	0.79	29.75	2.72	2.35	0.79	29.19	2.80	2.78	0.81	30.70	3.20	3.20	0.92	38.31	3.62	3.62	1.05	48.28
			19	-	-	-	-	4.05	2.34	1.17	58.04	4.03	2.77	1.16	57.40	4.00	3.20	1.15	56.72	3.96	3.62	1.14	55.84
			20	-	-	-	-	4.76	2.34	1.37	77.20	4.74	2.78	1.37	76.66	4.71	3.20	1.36	76.27	4.69	3.63	1.36	75.89
		4	15	1.67	1.67	0.36	7.57	2.11	2.11	0.45	11.25	2.54	2.54	0.55	15.48	2.96	2.96	0.64	20.32	3.39	3.39	0.73	25.73
			17	2.12	1.67	0.46	11.36	2.17	2.11	0.47	11.86	2.54	2.54	0.55	15.52	2.97	2.97	0.64	20.37	3.39	3.39	0.73	25.80
			19	-	-	-	-	3.47	2.11	0.75	26.80	3.44	2.54	0.74	26.47	3.41	2.97	0.74	26.02	3.47	3.40	0.75	26.81
			20	-	-	-	-	4.16	2.11	0.90	36.56	4.14	2.54	0.89	36.15	4.11	2.97	0.89	35.75	4.08	3.39	0.88	35.26
	5	15	1.42	1.42	0.24	3.88	1.86	1.86	0.32	6.20	2.30	2.30	0.40	8.87	2.73	2.73	0.47	11.89	3.15	3.15	0.54	15.31	
		17	1.49	1.42	0.26	4.26	1.86	1.86	0.32	6.21	2.30	2.30	0.40	8.89	2.73	2.73	0.47	11.92	3.16	3.16	0.54	15.35	
		19	-	-	-	-	2.83	1.87	0.49	12.69	2.80	2.30	0.48	12.44	2.85	2.73	0.49	12.84	3.16	3.16	0.54	15.36	
		20	-	-	-	-	3.55	1.87	0.61	18.71	3.52	2.30	0.61	18.49	3.49	2.73	0.60	18.19	3.47	3.16	0.60	18.02	
	6	15	1.19	1.19	0.17	1.64	1.61	1.61	0.23	3.48	2.06	2.06	0.29	5.35	2.49	2.49	0.36	7.41	2.92	2.92	0.42	9.72	
		17	1.19	1.19	0.17	1.64	1.61	1.61	0.23	3.49	2.06	2.06	0.30	5.37	2.49	2.49	0.36	7.43	2.92	2.92	0.42	9.74	
		19	-	-	-	-	2.15	1.62	0.31	5.76	2.20	2.06	0.32	5.99	2.50	2.50	0.36	7.47	2.93	2.93	0.42	9.77	
		20	-	-	-	-	2.90	1.63	0.42	9.61	2.87	2.07	0.41	9.43	2.85	2.50	0.41	9.32	3.00	2.93	0.43	10.19	

Continued:

MDVF-500D302E																							
EWT	ΔT	Indoor temp	Indoor temperature (D.B.)																				
			21				23				25				27				29				
			TC	SC	WF	WPD	TC	SC	WF	WPD	TC	SC	WF	WPD	TC	SC	WF	WPD	TC	SC	WF	WPD	
°C	°C	°C	kW	kW	m³/h	kPa	kW	kW	m³/h	kPa	kW	kW	m³/h	kPa	kW	kW	m³/h	kPa	kW	kW	m³/h	kPa	
11	3	15	1.48	1.48	0.42	9.87	1.92	1.92	0.55	15.36	2.35	2.35	0.67	21.78	2.77	2.77	0.79	29.07	3.19	3.19	0.92	37.50	
		17	1.63	1.48	0.46	11.62	1.92	1.91	0.55	15.36	2.35	2.35	0.67	21.83	2.77	2.77	0.79	29.14	3.20	3.20	0.92	37.60	
		19	-	-	-	-	2.96	1.92	0.84	32.59	2.93	2.35	0.84	32.00	2.92	2.78	0.83	31.89	3.20	3.20	0.92	37.96	
		20	-	-	-	-	3.67	1.92	1.05	47.46	3.64	2.35	1.04	46.91	3.61	2.78	1.03	46.30	3.58	3.20	1.02	45.51	
	4	15	1.24	1.24	0.26	4.42	1.68	1.68	0.36	7.45	2.11	2.11	0.45	11.03	2.54	2.54	0.54	15.15	2.96	2.96	0.63	19.77	
		17	1.23	1.23	0.26	4.42	1.68	1.68	0.36	7.47	2.11	2.11	0.45	11.06	2.54	2.54	0.54	15.19	2.97	2.97	0.64	19.82	
		19	-	-	-	-	2.31	1.68	0.49	12.87	2.31	2.11	0.49	12.84	2.55	2.55	0.55	15.26	2.97	2.97	0.64	19.87	
		20	-	-	-	-	3.03	1.68	0.65	20.57	3.00	2.11	0.64	20.26	2.97	2.54	0.64	19.89	3.05	2.97	0.65	20.81	
	5	15	1.00	1.00	0.17	1.72	1.43	1.43	0.25	3.92	1.88	1.88	0.32	6.19	2.31	2.31	0.40	8.81	2.74	2.74	0.47	11.78	
		17	1.00	1.00	0.17	1.73	1.44	1.44	0.25	3.93	1.88	1.88	0.32	6.20	2.31	2.31	0.40	8.83	2.74	2.74	0.47	11.81	
		19	-	-	-	-	1.64	1.44	0.28	4.91	1.89	1.89	0.33	6.28	2.32	2.32	0.40	8.86	2.74	2.74	0.47	11.84	
		20	-	-	-	-	2.37	1.45	0.41	9.20	2.34	1.88	0.40	9.01	2.43	2.32	0.42	9.58	2.75	2.74	0.47	11.86	
	6	15	0.81	0.81	0.12	0.70	1.20	1.20	0.17	1.73	1.63	1.63	0.23	3.54	2.07	2.07	0.30	5.28	2.50	2.50	0.36	7.30	
		17	0.81	0.81	0.12	0.70	1.20	1.20	0.17	1.74	1.63	1.63	0.23	3.55	2.07	2.07	0.30	5.30	2.50	2.50	0.36	7.32	
		19	-	-	-	-	1.21	1.20	0.17	1.78	1.63	1.63	0.23	3.56	2.07	2.07	0.30	5.31	2.51	2.51	0.36	7.34	
		20	-	-	-	-	1.60	1.19	0.23	3.44	1.72	1.64	0.25	3.90	2.07	2.07	0.30	5.32	2.51	2.51	0.36	7.35	
	13	3	15	1.05	1.05	0.30	5.47	1.49	1.49	0.43	9.93	1.92	1.92	0.55	15.40	2.35	2.35	0.68	21.80	2.77	2.77	0.79	28.66
			17	1.05	1.05	0.30	5.48	1.49	1.49	0.43	9.95	1.92	1.92	0.55	15.44	2.35	2.35	0.68	21.86	2.77	2.77	0.79	28.73
			19	-	-	-	-	1.76	1.48	0.50	13.06	1.94	1.93	0.56	15.62	2.36	2.36	0.68	21.92	2.78	2.78	0.79	28.81
			20	-	-	-	-	2.50	1.49	0.72	24.25	2.46	1.92	0.71	23.70	2.48	2.36	0.71	23.94	2.78	2.77	0.79	28.82
		4	15	0.80	0.80	0.17	1.79	1.25	1.25	0.27	4.47	1.68	1.68	0.36	7.37	2.11	2.11	0.45	10.90	2.54	2.54	0.55	15.14
			17	0.80	0.80	0.17	1.80	1.25	1.25	0.27	4.48	1.69	1.69	0.36	7.39	2.12	2.12	0.45	10.93	2.55	2.55	0.55	15.18
			19	-	-	-	-	1.26	1.26	0.27	4.57	1.69	1.69	0.36	7.41	2.12	2.12	0.45	10.96	2.55	2.55	0.55	15.22
			20	-	-	-	-	1.78	1.25	0.38	8.11	1.81	1.69	0.39	8.37	2.12	2.12	0.45	10.97	2.55	2.55	0.55	15.24
5		15	0.61	0.61	0.10	0.60	1.00	1.00	0.17	1.78	1.44	1.44	0.25	3.87	1.88	1.88	0.32	6.08	2.31	2.31	0.40	8.64	
		17	0.61	0.61	0.10	0.60	1.00	1.00	0.17	1.78	1.44	1.44	0.25	3.88	1.88	1.88	0.32	6.09	2.31	2.31	0.40	8.66	
		19	-	-	-	-	1.00	1.00	0.17	1.79	1.45	1.45	0.25	3.89	1.89	1.89	0.32	6.11	2.32	2.32	0.40	8.69	
		20	-	-	-	-	1.07	1.00	0.18	2.10	1.44	1.44	0.25	3.88	1.89	1.89	0.32	6.12	2.32	2.32	0.40	8.70	
6		15	0.40	0.40	0.06	0.32	0.81	0.81	0.12	0.68	1.20	1.20	0.17	1.80	1.64	1.64	0.23	3.52	2.08	2.08	0.30	5.26	
		17	0.41	0.41	0.06	0.32	0.82	0.82	0.12	0.68	1.20	1.20	0.17	1.81	1.64	1.64	0.23	3.53	2.08	2.08	0.30	5.27	
		19	-	-	-	-	0.82	0.82	0.12	0.68	1.20	1.20	0.17	1.81	1.64	1.64	0.24	3.54	2.09	2.09	0.30	5.29	
		20	-	-	-	-	0.82	0.82	0.12	0.69	1.20	1.20	0.17	1.82	1.65	1.65	0.24	3.54	2.09	2.09	0.30	5.30	
15		3	15	0.60	0.60	0.17	1.81	1.05	1.05	0.30	5.33	1.49	1.49	0.42	9.66	1.92	1.92	0.55	15.21	2.34	2.34	0.67	21.16
			17	0.60	0.60	0.17	1.82	1.05	1.05	0.30	5.35	1.49	1.49	0.43	9.69	1.93	1.93	0.55	15.25	2.35	2.35	0.67	21.22
			19	-	-	-	-	1.05	1.05	0.30	5.36	1.49	1.49	0.43	9.72	1.93	1.93	0.55	15.29	2.35	2.35	0.67	21.28
			20	-	-	-	-	1.20	1.05	0.34	6.72	1.49	1.48	0.43	9.70	1.93	1.93	0.56	15.32	2.35	2.35	0.67	21.31
		4	15	0.41	0.41	0.09	0.48	0.81	0.81	0.17	1.85	1.25	1.25	0.27	4.40	1.69	1.69	0.36	7.32	2.12	2.12	0.46	10.93
			17	0.41	0.41	0.09	0.48	0.81	0.81	0.17	1.85	1.25	1.25	0.27	4.41	1.69	1.69	0.36	7.34	2.13	2.13	0.46	10.96
			19	-	-	-	-	0.81	0.81	0.17	1.86	1.26	1.26	0.27	4.42	1.69	1.69	0.36	7.36	2.13	2.13	0.46	10.99
			20	-	-	-	-	0.81	0.79	0.17	1.85	1.26	1.26	0.27	4.43	1.70	1.70	0.36	7.37	2.13	2.13	0.46	11.00
	5	15	0.21	0.21	0.04	0.19	0.62	0.62	0.11	0.58	1.01	1.01	0.17	1.91	1.46	1.46	0.25	3.90	1.89	1.89	0.33	6.09	
		17	0.21	0.21	0.04	0.19	0.62	0.62	0.11	0.59	1.01	1.01	0.17	1.91	1.46	1.46	0.25	3.91	1.89	1.89	0.33	6.11	
		19	-	-	-	-	0.62	0.62	0.11	0.59	1.01	1.01	0.17	1.92	1.46	1.46	0.25	3.92	1.90	1.90	0.33	6.12	
		20	-	-	-	-	0.62	0.62	0.11	0.59	1.01	1.01	0.17	1.93	1.46	1.46	0.25	3.93	1.90	1.90	0.33	6.13	
	6	15	-	-	-	-	0.41	0.41	0.06	0.31	0.82	0.82	0.12	0.69	1.21	1.21	0.17	1.91	1.65	1.65	0.24	3.54	
		17	-	-	-	-	0.41	0.41	0.06	0.32	0.82	0.82	0.12	0.69	1.21	1.21	0.17	1.92	1.66	1.66	0.24	3.55	
		19	-	-	-	-	0.41	0.41	0.06	0.32	0.82	0.82	0.12	0.70	1.21	1.21	0.17	1.93	1.66	1.66	0.24	3.56	
		20	-	-	-	-	0.41	0.41	0.06	0.32	0.82	0.82	0.12	0.70	1.21	1.21	0.17	1.93	1.66	1.66	0.24	3.57	

EWT: Enter Water Temp. (°C) Δt: Temperature Difference (°C) DB: Dry Bulb Temp. (°C) WB: Wet Bulb Temp. (°C)
 TC: Total Cooling Capacity (kW) SC: Sensible Cooling Capacity (kW) WF: Water Flow (m³/h) WPD: Water Pressure Drop (kPa)

Cooling capacity

MDVF-600D302E																							
EWT	ΔT	Indoor temp (W.B.)	Indoor temperature (D.B.)																				
			21				23				25				27				29				
			TC	SC	WF	WPD	TC	SC	WF	WPD	TC	SC	WF	WPD	TC	SC	WF	WPD	TC	SC	WF	WPD	
°C	°C	°C	kW	kW	m³/h	kPa	kW	kW	m³/h	kPa	kW	kW	m³/h	kPa	kW	kW	m³/h	kPa	kW	kW	m³/h	kPa	
5	3	15	4.41	3.54	1.26	29.23	4.37	4.09	1.25	28.74	4.63	4.63	1.32	31.88	5.17	5.17	1.48	38.61	5.71	5.71	1.65	46.53	
		17	6.02	3.54	1.73	50.89	5.99	4.10	1.73	50.59	5.96	4.64	1.72	50.08	5.92	5.18	1.71	49.53	5.88	5.72	1.69	48.88	
		19	-	-	-	-	7.70	4.09	2.21	77.80	7.67	4.65	2.21	77.74	7.63	5.19	2.21	77.53	7.59	5.73	2.19	76.76	
		20	-	-	-	-	8.62	4.10	2.48	95.00	8.58	4.65	2.46	94.10	8.54	5.19	2.46	93.74	8.50	5.74	2.46	93.71	
	4	15	3.68	3.21	0.79	12.96	3.77	3.76	0.81	13.49	4.32	4.32	0.93	17.23	4.86	4.86	1.05	21.12	5.39	5.39	1.16	25.02	
		17	5.30	3.21	1.14	24.28	5.26	3.77	1.13	24.02	5.23	4.32	1.12	23.76	5.18	4.86	1.11	23.39	5.39	5.39	1.16	25.08	
		19	-	-	-	-	7.00	3.78	1.51	39.64	6.96	4.33	1.50	39.24	6.92	4.87	1.49	38.93	6.87	5.41	1.47	38.19	
		20	-	-	-	-	7.91	3.78	1.70	48.87	7.87	4.33	1.69	48.39	7.82	4.87	1.68	47.92	7.78	5.41	1.67	47.45	
	5	15	2.94	2.88	0.50	6.00	3.44	3.44	0.59	7.85	3.99	3.99	0.68	10.13	4.54	4.54	0.78	12.61	5.08	5.08	0.88	15.44	
		17	4.56	2.89	0.78	12.72	4.53	3.45	0.78	12.57	4.49	4.00	0.77	12.36	4.56	4.55	0.78	12.72	5.09	5.09	0.88	15.48	
		19	-	-	-	-	6.26	3.45	1.07	21.93	6.22	4.00	1.07	21.70	6.18	4.55	1.06	21.48	6.14	5.09	1.05	21.25	
		20	-	-	-	-	7.17	3.46	1.23	27.80	7.13	4.01	1.22	27.52	7.09	4.55	1.22	27.24	7.05	5.09	1.21	26.96	
	6	15	2.53	2.53	0.36	3.26	3.11	3.11	0.44	4.84	3.67	3.67	0.53	6.42	4.22	4.22	0.60	8.14	4.76	4.76	0.68	10.01	
		17	3.78	2.57	0.54	6.74	3.74	3.12	0.54	6.62	3.75	3.68	0.54	6.67	4.23	4.23	0.61	8.17	4.77	4.77	0.68	10.04	
		19	-	-	-	-	5.51	3.14	0.79	12.90	5.48	3.69	0.79	12.76	5.44	4.24	0.78	12.62	5.40	4.78	0.77	12.43	
		20	-	-	-	-	6.42	3.14	0.92	16.65	6.39	3.69	0.92	16.57	6.35	4.25	0.91	16.47	6.32	4.79	0.91	16.30	
	7	3	15	3.18	3.00	0.92	16.67	3.55	3.55	1.02	20.12	4.09	4.09	1.17	25.40	4.64	4.64	1.34	32.02	5.17	5.17	1.50	38.76
			17	4.80	3.00	1.39	33.97	4.77	3.55	1.38	33.59	4.73	4.10	1.37	33.11	4.71	4.64	1.36	32.93	5.18	5.18	1.50	38.87
			19	-	-	-	-	6.49	3.55	1.87	57.31	6.45	4.10	1.86	56.70	6.40	4.64	1.84	55.63	6.36	5.18	1.83	55.06
			20	-	-	-	-	7.41	3.56	2.15	72.95	7.37	4.11	2.14	72.23	7.32	4.65	2.12	71.49	7.28	5.19	2.11	70.78
		4	15	2.66	2.65	0.57	7.41	3.23	3.23	0.69	10.27	3.78	3.78	0.82	13.54	4.32	4.32	0.93	16.86	4.86	4.86	1.04	20.68
			17	4.04	2.68	0.87	15.21	4.01	3.23	0.87	14.98	3.98	3.78	0.86	14.79	4.32	4.32	0.93	16.91	4.86	4.86	1.05	20.73
			19	-	-	-	-	5.73	3.23	1.23	27.54	5.69	3.78	1.22	27.24	5.66	4.33	1.22	26.95	5.61	4.87	1.21	26.57
			20	-	-	-	-	6.64	3.23	1.43	35.62	6.61	3.79	1.43	35.54	6.58	4.34	1.42	35.36	6.54	4.88	1.41	34.99
5		15	2.33	2.33	0.40	3.99	2.90	2.90	0.50	5.80	3.45	3.45	0.59	7.82	4.00	4.00	0.69	10.05	4.54	4.54	0.78	12.50	
		17	3.23	2.35	0.56	6.96	3.19	2.90	0.55	6.83	3.46	3.45	0.59	7.82	4.01	4.01	0.69	10.08	4.55	4.55	0.78	12.53	
		19	-	-	-	-	4.95	2.91	0.85	14.50	4.92	3.47	0.85	14.33	4.92	3.96	0.89	18.54	4.84	4.56	0.83	13.94	
		20	-	-	-	-	5.87	2.92	1.01	19.40	5.83	3.47	1.00	19.19	5.79	4.02	1.00	18.98	5.75	4.56	0.99	18.77	
6		15	2.02	2.02	0.29	1.91	2.56	2.56	0.37	3.41	3.13	3.13	0.45	4.82	3.69	3.69	0.53	6.36	4.23	4.23	0.61	8.05	
		17	2.33	2.00	0.33	2.77	2.56	2.55	0.37	3.41	3.13	3.13	0.45	4.83	3.69	3.69	0.53	6.38	4.24	4.24	0.61	8.08	
		19	-	-	-	-	4.14	2.59	0.59	7.74	4.10	3.15	0.59	7.61	4.06	3.70	0.58	7.50	4.26	4.25	0.61	8.13	
		20	-	-	-	-	5.06	2.60	0.73	10.94	5.03	3.16	0.72	10.82	4.99	3.71	0.72	10.68	4.95	4.25	0.71	10.51	
9		3	15	2.44	2.44	0.70	10.28	2.99	2.99	0.86	14.65	3.54	3.54	1.02	19.55	4.09	4.09	1.17	25.06	4.63	4.63	1.34	31.56
			17	3.46	2.44	0.99	18.78	3.42	2.99	0.98	18.38	3.54	3.53	1.02	19.56	4.09	4.09	1.18	25.13	4.64	4.64	1.34	31.64
			19	-	-	-	-	5.16	3.00	1.48	37.62	5.13	3.55	1.47	37.20	5.09	4.10	1.46	36.74	5.04	4.64	1.45	36.14
			20	-	-	-	-	6.09	3.00	1.76	50.94	6.05	3.56	1.75	50.40	6.01	4.11	1.74	49.85	5.98	4.65	1.73	49.31
		4	15	2.11	2.11	0.45	4.89	2.68	2.68	0.58	7.32	3.23	3.23	0.69	10.11	3.78	3.78	0.82	13.39	4.32	4.32	0.93	16.70
			17	2.64	2.12	0.57	7.13	2.71	2.69	0.58	7.46	3.24	3.24	0.70	10.13	3.79	3.79	0.82	13.42	4.33	4.33	0.93	16.75
			19	-	-	-	-	4.37	2.69	0.94	17.07	4.34	3.24	0.94	16.83	4.29	3.79	0.92	16.51	4.37	4.34	0.94	17.02
			20	-	-	-	-	5.30	2.69	1.15	23.95	5.26	3.25	1.14	23.68	5.23	3.80	1.13	23.41	5.18	4.34	1.12	23.06
	5	15	1.78	1.78	0.31	2.25	2.35	2.35	0.40	3.99	2.91	2.91	0.50	5.75	3.47	3.47	0.60	7.74	4.01	4.01	0.69	9.94	
		17	1.80	1.78	0.31	2.34	2.35	2.35	0.40	4.00	2.92	2.92	0.50	5.77	3.47	3.47	0.60	7.76	4.02	4.02	0.69	9.97	
		19	-	-	-	-	3.53	2.37	0.61	8.00	3.49	2.92	0.60	7.83	3.55	3.48	0.61	8.06	4.02	4.02	0.69	10.00	
		20	-	-	-	-	4.46	2.37	0.77	11.94	4.43	2.93	0.76	11.79	4.39	3.48	0.76	11.59	4.36	4.03	0.75	11.45	
	6	15	1.53	1.53	0.22	0.94	2.02	2.02	0.29	1.99	2.58	2.58	0.37	3.42	3.15	3.15	0.45	4.79	3.70	3.70	0.53	6.31	
		17	1.53	1.52	0.22	0.94	2.03	2.03	0.29	2.00	2.59	2.59	0.37	3.43	3.15	3.15	0.45	4.81	3.71	3.71	0.53	6.33	
		19	-	-	-	-	2.59	2.03	0.37	3.44	2.65	2.60	0.38	3.59	3.16	3.15	0.45	4.82	3.71	3.71	0.53	6.35	
		20	-	-	-	-	3.59	2.05	0.51	5.98	3.54	2.61	0.51	5.86	3.52	3.16	0.50	5.78	3.73	3.72	0.54	6.41	

Continued:

MDVF-600D302E																						
EWT	ΔT	Indoor temp (W.B.)	Indoor temperature (D.B.)																			
			21				23				25				27				29			
			TC	SC	WF	WPD	TC	SC	WF	WPD	TC	SC	WF	WPD	TC	SC	WF	WPD	TC	SC	WF	WPD
°C	°C	°C	kW	kW	m³/h	kPa	kW	kW	m³/h	kPa	kW	kW	m³/h	kPa	kW	kW	m³/h	kPa	kW	kW	m³/h	kPa
11	3	15	1.88	1.88	0.54	6.42	2.44	2.44	0.70	10.03	3.00	3.00	0.86	14.39	3.54	3.54	1.01	19.05	4.08	4.08	1.17	24.41
		17	2.03	1.88	0.58	7.30	2.45	2.44	0.70	10.05	3.00	3.00	0.86	14.42	3.55	3.55	1.01	19.11	4.09	4.09	1.17	24.48
		19	-	-	-	-	3.75	2.45	1.07	21.02	3.71	3.00	1.06	20.62	3.69	3.55	1.05	20.49	4.10	4.10	1.17	24.55
		20	-	-	-	-	4.66	2.45	1.33	30.71	4.63	3.00	1.32	30.34	4.59	3.55	1.31	29.90	4.54	4.10	1.30	29.38
	4	15	1.55	1.55	0.33	2.76	2.12	2.12	0.45	4.82	2.68	2.68	0.57	7.18	3.23	3.23	0.69	9.89	3.78	3.78	0.81	12.93
		17	1.55	1.54	0.33	2.77	2.13	2.13	0.46	4.83	2.69	2.69	0.58	7.20	3.24	3.24	0.69	9.92	3.79	3.79	0.81	12.97
		19	-	-	-	-	2.88	2.13	0.62	8.12	2.87	2.69	0.62	8.08	3.24	3.23	0.69	9.94	3.79	3.79	0.81	13.01
		20	-	-	-	-	3.82	2.14	0.82	13.17	3.78	2.69	0.81	12.95	3.74	3.24	0.80	12.70	3.83	3.80	0.82	13.26
	5	15	1.28	1.28	0.22	0.97	1.79	1.79	0.31	2.37	2.37	2.37	0.41	3.99	2.93	2.93	0.50	5.72	3.48	3.48	0.60	7.67
		17	1.28	1.28	0.22	0.98	1.80	1.80	0.31	2.38	2.37	2.37	0.41	4.00	2.93	2.93	0.50	5.74	3.48	3.48	0.60	7.69
		19	-	-	-	-	1.96	1.80	0.34	2.86	2.37	2.36	0.41	4.00	2.94	2.94	0.51	5.75	3.49	3.49	0.60	7.72
		20	-	-	-	-	2.93	1.82	0.50	5.72	2.89	2.38	0.50	5.59	3.00	2.95	0.52	5.95	3.49	3.49	0.60	7.73
6	15	1.02	1.02	0.15	0.50	1.53	1.53	0.22	0.98	2.04	2.04	0.29	2.09	2.61	2.61	0.37	3.43	3.17	3.17	0.45	4.77	
	17	1.02	1.02	0.15	0.50	1.53	1.53	0.22	0.98	2.04	2.04	0.29	2.10	2.61	2.61	0.37	3.44	3.17	3.17	0.45	4.78	
	19	-	-	-	-	1.54	1.53	0.22	0.99	2.04	2.04	0.29	2.11	2.61	2.61	0.38	3.45	3.18	3.18	0.46	4.79	
	20	-	-	-	-	1.92	1.48	0.28	1.80	2.07	2.06	0.30	2.17	2.62	2.62	0.38	3.45	3.18	3.18	0.46	4.80	
13	3	15	1.32	1.32	0.38	3.52	1.89	1.89	0.54	6.46	2.45	2.45	0.70	10.06	2.99	2.99	0.85	14.04	3.54	3.54	1.02	19.05
		17	1.33	1.33	0.38	3.53	1.90	1.90	0.54	6.48	2.45	2.45	0.70	10.08	3.00	3.00	0.86	14.08	3.55	3.55	1.02	19.11
		19	-	-	-	-	2.22	1.90	0.64	8.46	2.45	2.43	0.70	10.07	3.00	3.00	0.86	14.12	3.56	3.56	1.02	19.16
		20	-	-	-	-	3.15	1.90	0.91	15.54	3.11	2.46	0.89	15.16	3.12	3.01	0.90	15.27	3.56	3.56	1.02	19.19
	4	15	1.03	1.03	0.22	1.00	1.56	1.56	0.34	2.85	2.14	2.14	0.46	4.84	2.69	2.69	0.58	7.10	3.24	3.24	0.69	9.76
		17	1.03	1.03	0.22	1.01	1.57	1.57	0.34	2.86	2.14	2.14	0.46	4.85	2.69	2.69	0.58	7.12	3.24	3.24	0.69	9.79
		19	-	-	-	-	1.56	1.54	0.34	2.84	2.14	2.14	0.46	4.87	2.70	2.70	0.58	7.14	3.25	3.25	0.70	9.82
		20	-	-	-	-	2.21	1.58	0.48	5.12	2.23	2.14	0.48	5.16	2.70	2.69	0.58	7.14	3.25	3.25	0.70	9.83
	5	15	0.77	0.77	0.13	0.43	1.28	1.28	0.22	0.99	1.80	1.80	0.31	2.41	2.37	2.37	0.41	3.92	2.93	2.93	0.50	5.61
		17	0.77	0.77	0.13	0.43	1.28	1.28	0.22	1.00	1.81	1.81	0.31	2.42	2.38	2.38	0.41	3.93	2.94	2.94	0.50	5.62
		19	-	-	-	-	1.28	1.28	0.22	1.00	1.81	1.81	0.31	2.43	2.38	2.38	0.41	3.94	2.94	2.94	0.50	5.64
		20	-	-	-	-	1.33	1.28	0.23	1.12	1.81	1.80	0.31	2.43	2.39	2.39	0.41	3.95	2.94	2.94	0.51	5.65
6	15	0.50	0.50	0.07	0.23	1.03	1.03	0.15	0.48	1.53	1.53	0.22	1.00	2.05	2.05	0.29	2.15	2.62	2.62	0.37	3.38	
	17	0.51	0.51	0.07	0.23	1.03	1.03	0.15	0.48	1.53	1.53	0.22	1.01	2.05	2.05	0.29	2.16	2.62	2.62	0.38	3.39	
	19	-	-	-	-	1.03	1.03	0.15	0.48	1.54	1.54	0.22	1.01	2.06	2.06	0.29	2.16	2.63	2.63	0.38	3.40	
	20	-	-	-	-	1.03	1.02	0.15	0.48	1.54	1.54	0.22	1.01	2.06	2.06	0.29	2.17	2.63	2.63	0.38	3.41	
15	3	15	0.77	0.77	0.22	1.01	1.33	1.33	0.38	3.43	1.89	1.89	0.54	6.29	2.45	2.45	0.70	9.78	2.99	2.99	0.85	13.86
		17	0.77	0.77	0.22	1.01	1.33	1.33	0.38	3.44	1.89	1.89	0.54	6.31	2.45	2.45	0.70	9.81	3.00	3.00	0.86	13.90
		19	-	-	-	-	1.33	1.33	0.38	3.45	1.90	1.90	0.54	6.33	2.45	2.45	0.70	9.83	3.00	3.00	0.86	13.94
		20	-	-	-	-	1.47	1.33	0.42	4.09	1.89	1.88	0.54	6.31	2.46	2.46	0.70	9.85	3.01	3.01	0.86	13.96
	4	15	0.51	0.51	0.11	0.35	1.03	1.03	0.22	1.03	1.57	1.57	0.34	2.82	2.14	2.14	0.46	4.74	2.69	2.69	0.58	7.03
		17	0.51	0.51	0.11	0.35	1.03	1.03	0.22	1.03	1.58	1.58	0.34	2.82	2.14	2.14	0.46	4.76	2.70	2.70	0.58	7.05
		19	-	-	-	-	1.03	1.03	0.22	1.04	1.58	1.58	0.34	2.83	2.15	2.15	0.46	4.77	2.70	2.70	0.58	7.07
		20	-	-	-	-	1.03	1.01	0.22	1.03	1.58	1.58	0.34	2.84	2.15	2.15	0.46	4.78	2.70	2.70	0.58	7.08
	5	15	0.25	0.25	0.04	0.14	0.78	0.78	0.13	0.42	1.28	1.28	0.22	1.06	1.82	1.82	0.31	2.48	2.39	2.39	0.41	3.94
		17	0.26	0.26	0.04	0.14	0.78	0.78	0.13	0.42	1.29	1.29	0.22	1.06	1.83	1.83	0.31	2.49	2.39	2.39	0.41	3.95
		19	-	-	-	-	0.78	0.78	0.13	0.42	1.29	1.29	0.22	1.07	1.83	1.83	0.32	2.50	2.40	2.40	0.41	3.96
		20	-	-	-	-	0.78	0.78	0.13	0.42	1.29	1.29	0.22	1.07	1.83	1.83	0.32	2.50	2.40	2.40	0.41	3.97
6	15	-	-	-	-	0.51	0.51	0.07	0.23	1.04	1.04	0.15	0.46	1.54	1.54	0.22	1.06	2.07	2.07	0.30	2.23	
	17	-	-	-	-	0.51	0.51	0.07	0.23	1.04	1.04	0.15	0.46	1.54	1.54	0.22	1.07	2.07	2.07	0.30	2.23	
	19	-	-	-	-	0.51	0.51	0.07	0.23	1.04	1.04	0.15	0.46	1.54	1.54	0.22	1.07	2.08	2.08	0.30	2.24	
	20	-	-	-	-	0.51	0.51	0.07	0.23	1.04	1.04	0.15	0.46	1.54	1.54	0.22	1.07	2.08	2.08	0.30	2.25	

EWT: Enter Water Temp. (°C) Δt: Temperature Difference (°C) DB: Dry Bulb Temp. (°C) WB: Wet Bulb Temp. (°C)
 TC: Total Cooling Capacity (kW) SC: Sensible Cooling Capacity (kW) WF: Water Flow (m³/h) WPD: Water Pressure Drop (kPa)

Cooling capacity

MDVF-800D302E																							
EWT	ΔT	Indoor temp (W.B.)	Indoor temperature (D.B.)																				
			21				23				25				27				29				
			TC	SC	WF	WPD	TC	SC	WF	WPD	TC	SC	WF	WPD	TC	SC	WF	WPD	TC	SC	WF	WPD	
°C	°C	°C	kW	kW	m³/h	kPa	kW	kW	m³/h	kPa	kW	kW	m³/h	kPa	kW	kW	m³/h	kPa	kW	kW	m³/h	kPa	
5	3	15	5.88	4.70	1.68	28.96	5.82	5.43	1.66	28.47	6.14	6.14	1.76	31.25	6.86	6.86	1.96	37.81	7.56	7.56	2.17	45.18	
		17	8.03	4.72	2.31	50.46	7.98	5.44	2.30	49.91	7.93	6.16	2.29	49.38	7.88	6.87	2.27	48.80	7.81	7.58	2.25	48.13	
		19	-	-	-	-	10.26	5.45	2.96	77.73	10.20	6.17	2.95	76.98	10.14	6.89	2.93	76.19	10.08	7.59	2.91	75.38	
		20	-	-	-	-	11.46	5.45	3.30	93.74	11.41	6.18	3.29	93.55	11.34	6.89	3.28	92.97	11.28	7.60	3.26	92.04	
	4	15	4.94	4.28	1.06	12.98	5.01	5.00	1.07	13.30	5.74	5.74	1.24	16.94	6.45	6.45	1.39	20.73	7.15	7.15	1.53	24.53	
		17	7.08	4.29	1.52	24.12	7.03	5.01	1.51	23.85	6.98	5.74	1.50	23.57	6.92	6.45	1.48	23.19	7.15	7.14	1.53	24.58	
		19	-	-	-	-	9.33	5.03	2.01	39.18	9.28	5.75	2.00	38.88	9.21	6.46	1.98	38.09	9.15	7.17	1.96	37.70	
		20	-	-	-	-	10.53	5.03	2.26	48.22	10.47	5.75	2.25	47.73	10.41	6.47	2.23	47.24	10.35	7.18	2.22	46.75	
	5	15	3.96	3.85	0.68	6.06	4.59	4.59	0.79	7.77	5.31	5.31	0.91	9.99	6.03	6.03	1.03	12.41	6.75	6.75	1.16	15.17	
		17	6.13	3.87	1.05	12.74	6.08	4.60	1.04	12.59	6.02	5.32	1.03	12.38	6.07	6.05	1.04	12.56	6.76	6.76	1.16	15.21	
		19	-	-	-	-	8.37	4.61	1.44	21.80	8.31	5.33	1.43	21.56	8.26	6.05	1.42	21.34	8.21	6.76	1.41	21.09	
		20	-	-	-	-	9.58	4.61	1.64	27.57	9.52	5.34	1.63	27.28	9.46	6.06	1.62	26.99	9.41	6.77	1.61	26.70	
	6	15	3.40	3.40	0.49	3.29	4.16	4.16	0.59	4.81	4.90	4.90	0.70	6.36	5.62	5.62	0.80	8.04	6.34	6.34	0.91	9.86	
		17	5.12	3.45	0.73	6.85	5.06	4.18	0.72	6.73	5.05	4.91	0.72	6.71	5.63	5.63	0.81	8.06	6.35	6.35	0.91	9.89	
		19	-	-	-	-	7.41	4.20	1.06	12.93	7.36	4.93	1.06	12.78	7.31	5.65	1.05	12.63	7.24	6.36	1.04	12.44	
		20	-	-	-	-	8.60	4.20	1.23	16.61	8.56	4.94	1.23	16.60	8.51	5.66	1.22	16.41	8.46	6.37	1.21	16.24	
	7	3	15	4.26	3.98	1.23	16.61	4.71	4.71	1.36	19.77	5.42	5.42	1.56	24.92	6.15	6.15	1.78	31.36	6.85	6.85	1.98	37.91
			17	6.40	3.99	1.85	33.63	6.35	4.72	1.84	33.23	6.30	5.44	1.82	32.75	6.27	6.16	1.81	32.45	6.86	6.86	1.98	38.02
			19	-	-	-	-	8.63	4.72	2.49	56.47	8.56	5.44	2.46	55.35	8.51	6.16	2.45	54.76	8.46	6.87	2.43	54.17
			20	-	-	-	-	9.85	4.73	2.86	71.82	9.79	5.46	2.84	71.05	9.73	6.17	2.82	70.29	9.66	6.88	2.79	68.97
4		15	3.55	3.53	0.77	7.33	4.29	4.29	0.93	10.13	5.02	5.02	1.09	13.32	5.73	5.73	1.23	16.56	6.44	6.44	1.38	20.27	
		17	5.42	3.57	1.17	15.19	5.37	4.30	1.16	14.95	5.33	5.03	1.15	14.74	5.74	5.74	1.23	16.61	6.45	6.45	1.39	20.33	
		19	-	-	-	-	7.65	4.30	1.64	27.30	7.60	5.03	1.63	26.99	7.55	5.75	1.62	26.69	7.48	6.46	1.61	26.30	
		20	-	-	-	-	8.87	4.31	1.91	35.54	8.82	5.04	1.91	35.32	8.76	5.76	1.90	34.94	8.71	6.47	1.88	34.56	
5		15	3.12	3.12	0.54	3.99	3.87	3.87	0.67	5.75	4.60	4.60	0.79	7.72	5.32	5.32	0.92	9.90	6.04	6.04	1.04	12.28	
		17	4.37	3.14	0.75	7.05	4.32	3.88	0.74	6.92	4.60	4.59	0.79	7.73	5.33	5.33	0.92	9.93	6.05	6.05	1.04	12.32	
		19	-	-	-	-	6.64	3.89	1.14	14.49	6.60	4.62	1.13	14.31	6.60	5.34	1.19	19.75	6.49	6.06	1.12	13.89	
		20	-	-	-	-	7.85	3.89	1.35	19.31	7.80	4.62	1.34	19.09	7.75	5.35	1.33	18.87	7.69	6.06	1.32	18.64	
6		15	2.71	2.71	0.39	1.94	3.44	3.44	0.49	3.42	4.18	4.18	0.60	4.78	4.91	4.91	0.70	6.29	5.63	5.63	0.81	7.94	
		17	3.21	2.70	0.46	2.97	3.43	3.41	0.49	3.41	4.19	4.19	0.60	4.79	4.92	4.92	0.70	6.30	5.64	5.64	0.81	7.96	
		19	-	-	-	-	5.59	3.48	0.80	7.83	5.53	4.21	0.79	7.70	5.48	4.93	0.79	7.58	5.67	5.66	0.81	8.03	
		20	-	-	-	-	6.81	3.48	0.98	10.99	6.76	4.22	0.97	10.86	6.71	4.94	0.96	10.72	6.65	5.66	0.95	10.54	
9		3	15	3.25	3.25	0.93	10.14	3.98	3.98	1.14	14.39	4.70	4.70	1.35	19.19	5.42	5.42	1.56	24.55	6.14	6.14	1.78	30.88
			17	4.63	3.25	1.33	18.68	4.57	3.98	1.31	18.30	4.70	4.68	1.35	19.19	5.43	5.43	1.56	24.63	6.15	6.15	1.78	30.97
			19	-	-	-	-	6.88	3.99	1.98	37.19	6.83	4.71	1.96	36.75	6.78	5.43	1.95	36.26	6.71	6.15	1.93	35.67
			20	-	-	-	-	8.10	4.00	2.35	50.26	8.05	4.73	2.33	49.68	8.00	5.45	2.32	49.12	7.95	6.16	2.30	48.58
	4	15	2.82	2.82	0.61	4.85	3.56	3.56	0.77	7.23	4.30	4.30	0.92	9.95	5.03	5.03	1.09	13.15	5.73	5.73	1.23	16.37	
		17	3.56	2.83	0.77	7.21	3.62	3.58	0.78	7.41	4.30	4.30	0.93	9.98	5.03	5.03	1.09	13.19	5.74	5.74	1.24	16.42	
		19	-	-	-	-	5.86	3.58	1.26	17.01	5.81	4.31	1.25	16.76	5.75	5.03	1.24	16.44	5.80	5.76	1.25	16.74	
		20	-	-	-	-	7.08	3.59	1.53	23.78	7.03	4.32	1.52	23.50	6.98	5.04	1.51	23.21	6.91	5.76	1.49	22.68	
	5	15	2.39	2.39	0.41	2.28	3.14	3.14	0.54	3.97	3.88	3.88	0.67	5.69	4.61	4.61	0.79	7.63	5.33	5.33	0.92	9.77	
		17	2.45	2.39	0.42	2.44	3.14	3.14	0.54	3.98	3.89	3.89	0.67	5.71	4.62	4.62	0.79	7.65	5.34	5.34	0.92	9.80	
		19	-	-	-	-	4.77	3.17	0.82	8.07	4.71	3.90	0.81	7.90	4.75	4.63	0.82	8.02	5.35	5.35	0.92	9.83	
		20	-	-	-	-	5.99	3.17	1.03	11.96	5.95	3.91	1.02	11.80	5.89	4.63	1.01	11.60	5.84	5.35	1.01	11.44	
	6	15	2.06	2.06	0.30	0.95	2.72	2.72	0.39	2.01	3.46	3.46	0.50	3.41	4.20	4.20	0.60	4.74	4.93	4.93	0.71	6.22	
		17	2.06	2.04	0.30	0.95	2.72	2.72	0.39	2.02	3.46	3.46	0.50	3.42	4.21	4.21	0.60	4.76	4.93	4.93	0.71	6.24	
		19	-	-	-	-	3.56	2.73	0.51	3.59	3.60	3.47	0.52	3.65	4.21	4.21	0.60	4.77	4.94	4.94	0.71	6.26	
		20	-	-	-	-	4.86	2.76	0.70	6.09	4.81	3.49	0.69	5.96	4.76	4.22	0.68	5.87	4.98	4.96	0.71	6.34	

Continued:

MDVF-800D302E																							
EWT	ΔT	Indoor temp (W.B.)	Indoor temperature (D.B.)																				
			21				23				25				27				29				
			TC	SC	WF	WPD	TC	SC	WF	WPD	TC	SC	WF	WPD	TC	SC	WF	WPD	TC	SC	WF	WPD	
°C	°C	°C	kW	kW	m³/h	kPa	kW	kW	m³/h	kPa	kW	kW	m³/h	kPa	kW	kW	m³/h	kPa	kW	kW	m³/h	kPa	
11	3	15	2.51	2.51	0.71	6.35	3.25	3.25	0.93	9.87	3.98	3.98	1.14	14.17	4.70	4.70	1.34	18.68	5.41	5.41	1.54	23.89	
		17	2.74	2.51	0.78	7.36	3.25	3.25	0.93	9.90	3.99	3.99	1.14	14.20	4.71	4.71	1.34	18.73	5.42	5.42	1.55	23.96	
		19	-	-	-	-	5.01	3.26	1.43	20.87	4.95	3.99	1.41	20.46	4.93	4.71	1.41	20.28	5.43	5.43	1.55	24.04	
		20	-	-	-	-	6.22	3.26	1.77	30.40	6.17	3.99	1.76	30.01	6.12	4.72	1.75	29.56	6.06	5.43	1.73	29.06	
	4	15	2.07	2.07	0.44	2.77	2.83	2.83	0.61	4.78	3.57	3.57	0.76	7.08	4.30	4.30	0.92	9.73	5.01	5.01	1.07	12.69	
		17	2.08	2.06	0.44	2.77	2.84	2.84	0.61	4.79	3.58	3.58	0.77	7.11	4.30	4.30	0.92	9.76	5.02	5.02	1.08	12.72	
		19	-	-	-	-	3.89	2.85	0.83	8.18	3.87	3.58	0.83	8.11	4.31	4.29	0.92	9.77	5.03	5.03	1.08	12.76	
		20	-	-	-	-	5.12	2.85	1.10	13.16	5.07	3.59	1.09	12.94	5.02	4.31	1.07	12.69	5.10	5.05	1.09	13.06	
	5	15	1.73	1.73	0.30	0.99	2.41	2.41	0.41	2.38	3.16	3.16	0.54	3.96	3.90	3.90	0.67	5.64	4.62	4.62	0.80	7.55	
		17	1.73	1.73	0.30	0.99	2.41	2.41	0.42	2.39	3.17	3.17	0.55	3.97	3.90	3.90	0.67	5.66	4.63	4.63	0.80	7.57	
		19	-	-	-	-	2.69	2.42	0.46	3.00	3.17	3.14	0.55	3.97	3.91	3.91	0.67	5.68	4.64	4.64	0.80	7.60	
		20	-	-	-	-	3.97	2.44	0.68	5.82	3.92	3.18	0.67	5.69	4.01	3.92	0.69	5.92	4.64	4.64	0.80	7.61	
	6	15	1.38	1.38	0.20	0.50	2.06	2.06	0.30	0.99	2.74	2.74	0.39	2.11	3.48	3.48	0.50	3.40	4.22	4.22	0.61	4.71	
		17	1.38	1.38	0.20	0.50	2.06	2.06	0.30	0.99	2.74	2.74	0.39	2.12	3.49	3.49	0.50	3.41	4.22	4.22	0.61	4.72	
		19	-	-	-	-	2.07	2.07	0.30	1.01	2.75	2.75	0.39	2.12	3.49	3.49	0.50	3.42	4.23	4.23	0.61	4.74	
		20	-	-	-	-	2.66	2.00	0.38	1.97	2.79	2.76	0.40	2.21	3.50	3.49	0.50	3.43	4.24	4.24	0.61	4.74	
	13	3	15	1.77	1.77	0.51	3.50	2.52	2.52	0.72	6.38	3.25	3.25	0.93	9.88	3.97	3.97	1.13	13.77	4.70	4.70	1.35	18.65
			17	1.77	1.77	0.51	3.51	2.52	2.52	0.72	6.39	3.26	3.26	0.94	9.91	3.98	3.98	1.13	13.81	4.71	4.71	1.35	18.71
			19	-	-	-	-	2.98	2.52	0.86	8.51	3.26	3.23	0.94	9.90	3.98	3.98	1.14	13.85	4.71	4.71	1.36	18.77
			20	-	-	-	-	4.22	2.53	1.21	15.48	4.16	3.26	1.20	15.10	4.16	4.00	1.20	15.13	4.72	4.71	1.36	18.79
		4	15	1.38	1.38	0.30	1.02	2.09	2.09	0.45	2.84	2.85	2.85	0.61	4.78	3.57	3.57	0.77	6.98	4.30	4.30	0.92	9.58
			17	1.38	1.38	0.30	1.02	2.10	2.10	0.45	2.85	2.85	2.85	0.61	4.80	3.58	3.58	0.77	7.01	4.30	4.30	0.92	9.61
			19	-	-	-	-	2.09	2.06	0.45	2.83	2.86	2.86	0.62	4.81	3.58	3.58	0.77	7.03	4.31	4.31	0.92	9.64
			20	-	-	-	-	2.97	2.11	0.64	5.10	3.00	2.85	0.64	5.19	3.58	3.57	0.77	7.03	4.31	4.31	0.92	9.66
5		15	1.04	1.04	0.18	0.43	1.72	1.72	0.29	1.01	2.41	2.41	0.41	2.41	3.17	3.17	0.54	3.88	3.90	3.90	0.67	5.52	
		17	1.04	1.04	0.18	0.43	1.72	1.72	0.30	1.01	2.42	2.42	0.41	2.42	3.17	3.17	0.54	3.89	3.91	3.91	0.67	5.54	
		19	-	-	-	-	1.72	1.72	0.30	1.02	2.42	2.42	0.42	2.43	3.18	3.18	0.55	3.90	3.91	3.91	0.67	5.56	
		20	-	-	-	-	1.82	1.71	0.31	1.18	2.42	2.41	0.42	2.43	3.18	3.18	0.55	3.91	3.92	3.92	0.67	5.57	
6		15	0.69	0.69	0.10	0.24	1.39	1.39	0.20	0.48	2.06	2.06	0.29	1.02	2.75	2.75	0.39	2.15	3.49	3.49	0.50	3.35	
		17	0.69	0.69	0.10	0.24	1.39	1.39	0.20	0.48	2.06	2.06	0.29	1.02	2.75	2.75	0.39	2.16	3.50	3.50	0.50	3.36	
		19	-	-	-	-	1.39	1.39	0.20	0.48	2.06	2.06	0.30	1.03	2.76	2.76	0.39	2.17	3.51	3.51	0.50	3.37	
		20	-	-	-	-	1.39	1.38	0.20	0.48	2.07	2.07	0.30	1.03	2.76	2.76	0.39	2.17	3.51	3.51	0.50	3.38	
15		3	15	1.04	1.04	0.30	1.02	1.77	1.77	0.50	3.41	2.52	2.52	0.72	6.20	3.25	3.25	0.93	9.60	3.97	3.97	1.13	13.58
			17	1.04	1.04	0.30	1.03	1.77	1.77	0.51	3.42	2.52	2.52	0.72	6.21	3.25	3.25	0.93	9.63	3.98	3.98	1.13	13.62
			19	-	-	-	-	1.78	1.78	0.51	3.43	2.52	2.52	0.72	6.23	3.26	3.26	0.93	9.66	3.98	3.98	1.14	13.66
			20	-	-	-	-	2.00	1.78	0.57	4.19	2.52	2.50	0.72	6.22	3.26	3.26	0.93	9.68	3.99	3.99	1.14	13.69
		4	15	0.69	0.69	0.15	0.35	1.38	1.38	0.30	1.04	2.10	2.10	0.45	2.80	2.85	2.85	0.61	4.68	3.58	3.58	0.77	6.91
			17	0.70	0.70	0.15	0.35	1.38	1.38	0.30	1.05	2.11	2.11	0.45	2.80	2.85	2.85	0.61	4.69	3.58	3.58	0.77	6.93
			19	-	-	-	-	1.38	1.38	0.30	1.05	2.11	2.11	0.45	2.81	2.86	2.86	0.61	4.71	3.59	3.59	0.77	6.95
			20	-	-	-	-	1.38	1.36	0.30	1.04	2.11	2.11	0.45	2.82	2.86	2.86	0.61	4.72	3.59	3.59	0.77	6.96
	5	15	0.35	0.35	0.06	0.14	1.05	1.05	0.18	0.42	1.72	1.72	0.30	1.07	2.44	2.44	0.42	2.47	3.18	3.18	0.55	3.89	
		17	0.35	0.35	0.06	0.14	1.05	1.05	0.18	0.42	1.73	1.73	0.30	1.07	2.44	2.44	0.42	2.48	3.19	3.19	0.55	3.90	
		19	-	-	-	-	1.05	1.05	0.18	0.42	1.73	1.73	0.30	1.08	2.45	2.45	0.42	2.48	3.20	3.20	0.55	3.91	
		20	-	-	-	-	1.05	1.05	0.18	0.42	1.73	1.73	0.30	1.08	2.45	2.45	0.42	2.49	3.20	3.20	0.55	3.92	
	6	15	-	-	-	-	0.70	0.70	0.10	0.23	1.40	1.40	0.20	0.46	2.06	2.06	0.30	1.07	2.77	2.77	0.40	2.22	
		17	-	-	-	-	0.70	0.70	0.10	0.23	1.40	1.40	0.20	0.46	2.06	2.06	0.30	1.08	2.77	2.77	0.40	2.22	
		19	-	-	-	-	0.70	0.70	0.10	0.23	1.40	1.40	0.20	0.46	2.07	2.07	0.30	1.08	2.78	2.78	0.40	2.23	
		20	-	-	-	-	0.70	0.70	0.10	0.23	1.40	1.40	0.20	0.46	2.07	2.07	0.30	1.08	2.78	2.78	0.40	2.24	

EWT: Enter Water Temp. (°C) Δt: Temperature Difference (°C) DB: Dry Bulb Temp. (°C) WB: Wet Bulb Temp. (°C)
 TC: Total Cooling Capacity (kW) SC: Sensible Cooling Capacity (kW) WF: Water Flow (m³/h) WPD: Water Pressure Drop (kPa)

Cooling capacity

MDVF-1000D302E																							
EWT	ΔT	Indoor temp (W.B.)	Indoor temperature (D.B.)																				
			21				23				25				27				29				
			TC	SC	WF	WPD	TC	SC	WF	WPD	TC	SC	WF	WPD	TC	SC	WF	WPD	TC	SC	WF	WPD	
°C	°C	°C	kW	kW	m³/h	kPa	kW	kW	m³/h	kPa	kW	kW	m³/h	kPa	kW	kW	m³/h	kPa	kW	kW	m³/h	kPa	
5	3	15	6.97	5.54	1.99	42.32	6.92	6.40	1.99	41.99	7.24	7.24	2.08	45.55	8.08	8.08	2.31	54.76	8.91	8.91	2.57	65.97	
		17	9.48	5.56	2.74	73.51	9.42	6.41	2.72	72.76	9.35	7.25	2.68	70.82	9.28	8.08	2.66	70.01	9.22	8.91	2.64	69.14	
		19	-	-	-	-	12.10	6.42	3.51	113.49	12.01	7.26	3.46	110.55	11.95	8.10	3.44	109.65	11.89	8.94	3.44	109.65	
		20	-	-	-	-	13.52	6.42	3.91	137.70	13.43	7.26	3.87	134.96	13.35	8.11	3.85	133.67	13.28	8.94	3.83	132.38	
	4	15	5.91	5.07	1.27	19.39	5.99	5.93	1.29	19.84	6.76	6.76	1.45	24.23	7.60	7.60	1.63	29.69	8.43	8.43	1.81	35.55	
		17	8.40	5.07	1.80	35.28	8.34	5.92	1.79	34.91	8.29	6.77	1.78	34.53	8.22	7.61	1.76	34.01	8.45	8.45	1.81	35.68	
		19	-	-	-	-	11.05	5.94	2.39	57.53	10.98	6.79	2.37	56.94	10.91	7.63	2.35	56.00	10.84	8.46	2.34	55.44	
		20	-	-	-	-	12.44	5.93	2.67	70.23	12.37	6.78	2.66	69.53	12.30	7.63	2.64	68.84	12.23	8.46	2.63	68.16	
	5	15	4.81	4.58	0.83	9.17	5.44	5.44	0.93	11.31	6.29	6.29	1.08	14.51	7.14	7.14	1.23	18.17	7.96	7.96	1.37	21.76	
		17	7.33	4.60	1.26	18.99	7.28	5.46	1.25	18.77	7.21	6.31	1.24	18.47	7.29	7.16	1.26	18.80	7.98	7.98	1.37	21.82	
		19	-	-	-	-	9.95	5.46	1.72	32.28	9.89	6.31	1.71	31.94	9.84	7.16	1.70	31.61	9.77	8.00	1.68	31.26	
		20	-	-	-	-	11.37	5.46	1.96	40.69	11.30	6.32	1.95	40.28	11.24	7.16	1.94	39.87	11.17	8.00	1.93	39.46	
6	15	4.08	4.06	0.58	5.06	4.96	4.96	0.71	7.06	5.82	5.82	0.83	9.27	6.67	6.67	0.96	11.75	7.51	7.51	1.08	14.39		
	17	6.17	4.11	0.88	10.25	6.11	4.97	0.88	10.07	6.12	5.83	0.88	10.10	6.68	6.67	0.96	11.77	7.52	7.52	1.08	14.43		
	19	-	-	-	-	8.81	4.98	1.26	18.83	8.76	5.83	1.25	18.62	8.70	6.68	1.24	18.41	8.62	7.52	1.23	18.14		
	20	-	-	-	-	10.24	4.98	1.46	24.39	10.17	5.84	1.46	24.14	10.11	6.69	1.45	23.88	10.05	7.53	1.44	23.63		
7	3	15	5.05	4.69	1.45	23.89	5.56	5.55	1.61	28.61	6.40	6.40	1.85	36.61	7.23	7.23	2.08	44.75	8.06	8.06	2.32	54.18	
		17	7.55	4.69	2.17	48.20	7.50	5.55	2.15	47.66	7.44	6.40	2.14	46.99	7.41	7.24	2.13	46.74	8.08	8.08	2.32	54.33	
		19	-	-	-	-	10.20	5.57	2.96	83.09	10.14	6.42	2.94	82.24	10.06	7.25	2.90	79.98	10.00	8.09	2.88	79.15	
		20	-	-	-	-	11.60	5.56	3.35	103.02	11.53	6.42	3.33	102.34	11.48	7.27	3.33	102.39	11.42	8.11	3.32	101.56	
	4	15	4.23	4.23	0.91	10.73	5.08	5.08	1.10	14.78	5.92	5.92	1.27	19.08	6.77	6.77	1.46	24.01	7.61	7.61	1.65	29.72	
		17	6.43	4.22	1.38	21.97	6.37	5.08	1.37	21.64	6.33	5.93	1.36	21.40	6.77	6.77	1.46	24.06	7.62	7.62	1.65	29.80	
		19	-	-	-	-	9.06	5.08	1.95	39.88	9.00	5.94	1.94	39.43	8.94	6.78	1.93	39.00	8.88	7.62	1.91	38.48	
		20	-	-	-	-	10.50	5.09	2.27	52.11	10.43	5.95	2.26	51.56	10.37	6.80	2.25	51.03	10.31	7.64	2.23	50.50	
	5	15	3.73	3.73	0.64	5.86	4.60	4.60	0.79	8.38	5.46	5.46	0.94	11.22	6.30	6.30	1.08	14.38	7.14	7.14	1.23	17.81	
		17	5.26	3.74	0.90	10.53	5.21	4.60	0.90	10.35	5.50	5.47	0.95	11.37	6.31	6.31	1.09	14.42	7.15	7.15	1.23	17.86	
		19	-	-	-	-	7.91	4.61	1.36	21.27	7.86	5.47	1.35	21.03	7.82	6.26	1.41	30.46	7.74	7.16	1.33	20.49	
		20	-	-	-	-	9.36	4.62	1.62	28.66	9.30	5.48	1.61	28.35	9.24	6.33	1.60	28.04	9.18	7.17	1.59	27.73	
6	15	3.23	3.23	0.46	3.25	4.11	4.11	0.59	5.05	4.98	4.98	0.71	6.99	5.83	5.83	0.84	9.16	6.68	6.68	0.96	11.55		
	17	3.96	3.23	0.57	4.74	4.19	4.12	0.60	5.22	4.99	4.99	0.71	7.01	5.84	5.84	0.84	9.19	6.69	6.69	0.96	11.58		
	19	-	-	-	-	6.72	4.14	0.96	11.66	6.66	5.00	0.95	11.48	6.60	5.85	0.95	11.32	6.82	6.70	0.98	11.98		
	20	-	-	-	-	8.15	4.15	1.17	16.26	8.09	5.01	1.16	16.07	8.03	5.86	1.15	15.88	7.96	6.70	1.14	15.62		
9	3	15	3.84	3.84	1.10	14.73	4.70	4.70	1.35	20.81	5.56	5.56	1.61	28.22	6.39	6.39	1.84	35.55	7.23	7.23	2.10	44.76	
		17	5.53	3.85	1.60	27.97	5.47	4.71	1.58	27.43	5.60	5.57	1.62	28.57	6.40	6.40	1.84	35.65	7.25	7.25	2.10	44.89	
		19	-	-	-	-	8.13	4.70	2.34	54.30	8.08	5.56	2.33	53.66	8.02	6.40	2.31	52.99	7.95	7.24	2.29	52.13	
		20	-	-	-	-	9.57	4.71	2.78	73.39	9.50	5.56	2.74	71.37	9.46	6.42	2.75	71.83	9.40	7.26	2.73	71.02	
	4	15	3.36	3.36	0.72	7.10	4.23	4.23	0.91	10.52	5.08	5.08	1.09	14.44	5.93	5.93	1.28	18.95	6.77	6.77	1.47	23.95	
		17	4.29	3.36	0.92	10.78	4.37	4.24	0.94	11.12	5.09	5.09	1.10	14.48	5.94	5.94	1.28	19.00	6.78	6.78	1.47	24.02	
		19	-	-	-	-	6.98	4.24	1.51	25.21	6.92	5.10	1.50	24.88	6.86	5.95	1.48	24.45	6.94	6.80	1.50	24.97	
		20	-	-	-	-	8.37	4.23	1.80	34.30	8.32	5.09	1.79	33.91	8.26	5.94	1.78	33.51	8.19	6.79	1.76	33.01	
	5	15	2.86	2.86	0.49	3.67	3.75	3.75	0.64	5.82	4.61	4.61	0.79	8.30	5.47	5.47	0.94	11.10	6.32	6.32	1.09	14.29	
		17	3.04	2.87	0.52	4.09	3.75	3.74	0.65	5.83	4.62	4.62	0.80	8.32	5.48	5.48	0.94	11.13	6.33	6.33	1.09	14.33	
		19	-	-	-	-	5.73	3.76	0.99	12.02	5.66	4.62	0.97	11.78	5.73	5.48	0.99	12.03	6.33	6.32	1.09	14.36	
		20	-	-	-	-	7.16	3.77	1.23	17.65	7.11	4.63	1.22	17.43	7.04	5.48	1.21	17.14	6.99	6.33	1.20	16.95	
6	15	2.41	2.41	0.35	1.59	3.25	3.25	0.47	3.30	4.14	4.14	0.59	5.03	5.00	5.00	0.72	6.94	5.85	5.85	0.84	9.07		
	17	2.42	2.41	0.35	1.59	3.25	3.25	0.47	3.31	4.14	4.14	0.59	5.04	5.01	5.01	0.72	6.96	5.86	5.86	0.84	9.10		
	19	-	-	-	-	4.39	3.28	0.63	5.55	4.44	4.15	0.64	5.68	5.02	5.02	0.72	6.99	5.87	5.87	0.84	9.12		
	20	-	-	-	-	5.88	3.30	0.84	9.14	5.81	4.16	0.83	8.97	5.77	5.01	0.83	8.85	6.02	5.88	0.86	9.54		

Continued:

MDVF-1000D302E																							
EWT	ΔT	Indoor temp (W.B.)	Indoor temperature (D.B.)																				
			21				23				25				27				29				
°C	°C	°C	TC	SC	WF	WPD	TC	SC	WF	WPD	TC	SC	WF	WPD	TC	SC	WF	WPD	TC	SC	WF	WPD	
			kW	kW	m³/h	kPa	kW	kW	m³/h	kPa	kW	kW	m³/h	kPa	kW	kW	m³/h	kPa	kW	kW	m³/h	kPa	
11	3	15	2.98	2.98	0.85	9.24	3.85	3.85	1.10	14.46	4.70	4.70	1.34	20.29	5.54	5.54	1.59	27.15	6.39	6.39	1.83	34.86	
		17	3.29	2.97	0.94	11.00	3.85	3.83	1.10	14.47	4.70	4.70	1.34	20.34	5.55	5.55	1.59	27.23	6.40	6.40	1.83	34.95	
		19	-	-	-	-	5.95	3.84	1.70	30.59	5.88	4.70	1.68	30.00	5.86	5.56	1.67	29.82	6.40	6.39	1.84	35.03	
		20	-	-	-	-	7.36	3.84	2.10	44.43	7.31	4.70	2.09	43.90	7.25	5.56	2.07	43.27	7.19	6.41	2.06	42.85	
	4	15	2.49	2.49	0.53	4.17	3.37	3.37	0.72	6.98	4.23	4.23	0.91	10.30	5.08	5.08	1.09	14.12	5.93	5.93	1.27	18.40	
		17	2.49	2.47	0.53	4.16	3.38	3.38	0.72	7.00	4.24	4.24	0.91	10.33	5.09	5.09	1.09	14.16	5.93	5.93	1.27	18.45	
		19	-	-	-	-	4.67	3.38	1.00	12.18	4.65	4.24	1.00	12.11	5.11	5.10	1.09	14.23	5.94	5.94	1.27	18.50	
		20	-	-	-	-	6.11	3.38	1.31	19.39	6.05	4.24	1.30	19.06	5.99	5.09	1.28	18.72	6.11	5.96	1.31	19.38	
	5	15	2.03	2.03	0.35	1.66	2.89	2.89	0.50	3.69	3.77	3.77	0.65	5.79	4.63	4.63	0.80	8.23	5.48	5.48	0.94	10.98	
		17	2.03	2.03	0.35	1.67	2.90	2.90	0.50	3.70	3.78	3.78	0.65	5.81	4.64	4.64	0.80	8.25	5.49	5.49	0.94	11.01	
		19	-	-	-	-	3.34	2.90	0.58	4.72	3.81	3.79	0.66	5.89	4.65	4.65	0.80	8.28	5.50	5.50	0.95	11.04	
		20	-	-	-	-	4.80	2.91	0.83	8.74	4.74	3.78	0.82	8.56	4.87	4.65	0.84	8.98	5.50	5.49	0.95	11.05	
	6	15	1.65	1.65	0.24	0.66	2.42	2.42	0.35	1.67	3.28	3.28	0.47	3.34	4.16	4.16	0.60	5.00	5.01	5.01	0.72	6.82	
		17	1.65	1.65	0.24	0.67	2.43	2.43	0.35	1.68	3.29	3.29	0.47	3.35	4.17	4.17	0.60	5.01	5.02	5.02	0.72	6.84	
		19	-	-	-	-	2.45	2.44	0.35	1.72	3.29	3.29	0.47	3.36	4.17	4.17	0.60	5.03	5.03	5.03	0.72	6.86	
		20	-	-	-	-	3.31	2.41	0.48	3.39	3.48	3.30	0.50	3.69	4.18	4.17	0.60	5.03	5.03	5.03	0.72	6.87	
	13	3	15	2.11	2.11	0.61	5.13	2.99	2.99	0.86	9.28	3.84	3.84	1.10	14.11	4.70	4.70	1.35	20.30	5.54	5.54	1.59	26.83
			17	2.12	2.12	0.61	5.15	2.99	2.99	0.86	9.30	3.84	3.84	1.10	14.15	4.71	4.71	1.35	20.35	5.55	5.55	1.59	26.91
			19	-	-	-	-	3.58	2.99	1.03	12.66	3.87	3.86	1.10	14.29	4.72	4.72	1.36	20.41	5.56	5.56	1.59	26.99
			20	-	-	-	-	5.03	2.99	1.44	22.79	4.96	3.86	1.43	22.27	4.97	4.72	1.43	22.39	5.56	5.54	1.59	27.00
		4	15	1.63	1.63	0.35	1.73	2.51	2.51	0.54	4.20	3.38	3.38	0.72	6.89	4.23	4.23	0.91	10.17	5.08	5.08	1.09	13.92
			17	1.63	1.63	0.35	1.73	2.51	2.51	0.54	4.21	3.38	3.38	0.72	6.91	4.24	4.24	0.91	10.19	5.09	5.09	1.09	13.96
			19	-	-	-	-	2.54	2.53	0.55	4.29	3.39	3.39	0.73	6.93	4.25	4.25	0.91	10.22	5.10	5.10	1.09	14.00
			20	-	-	-	-	3.61	2.51	0.77	7.73	3.66	3.39	0.78	7.90	4.25	4.24	0.91	10.23	5.10	5.10	1.09	14.03
5		15	1.24	1.24	0.21	0.57	2.02	2.02	0.35	1.71	2.90	2.90	0.50	3.63	3.77	3.77	0.65	5.68	4.63	4.63	0.79	8.06	
		17	1.24	1.24	0.21	0.57	2.03	2.03	0.35	1.71	2.91	2.91	0.50	3.64	3.78	3.78	0.65	5.70	4.64	4.64	0.80	8.08	
		19	-	-	-	-	2.03	2.03	0.35	1.72	2.91	2.91	0.50	3.65	3.79	3.79	0.65	5.71	4.65	4.65	0.80	8.10	
		20	-	-	-	-	2.18	2.02	0.37	2.08	2.91	2.89	0.50	3.65	3.79	3.79	0.65	5.72	4.65	4.65	0.80	8.12	
6		15	0.83	0.83	0.12	0.31	1.66	1.66	0.24	0.65	2.43	2.43	0.35	1.73	3.30	3.30	0.47	3.31	4.17	4.17	0.60	4.92	
		17	0.83	0.83	0.12	0.31	1.66	1.66	0.24	0.65	2.43	2.43	0.35	1.73	3.30	3.30	0.47	3.32	4.18	4.18	0.60	4.93	
		19	-	-	-	-	1.66	1.66	0.24	0.65	2.43	2.43	0.35	1.74	3.31	3.31	0.47	3.33	4.19	4.19	0.60	4.95	
		20	-	-	-	-	1.68	1.67	0.24	0.66	2.44	2.44	0.35	1.75	3.31	3.31	0.47	3.33	4.19	4.19	0.60	4.96	
15		3	15	1.22	1.22	0.35	1.74	2.11	2.11	0.60	5.00	2.98	2.98	0.85	9.02	3.84	3.84	1.10	13.94	4.69	4.69	1.35	19.99
			17	1.22	1.22	0.35	1.75	2.12	2.12	0.60	5.01	2.99	2.99	0.85	9.04	3.85	3.85	1.10	13.98	4.70	4.70	1.35	20.05
			19	-	-	-	-	2.12	2.12	0.60	5.03	2.99	2.99	0.85	9.07	3.85	3.85	1.10	14.02	4.71	4.71	1.35	20.11
			20	-	-	-	-	2.44	2.12	0.70	6.40	2.99	2.97	0.85	9.06	3.86	3.86	1.10	14.04	4.71	4.71	1.36	20.14
		4	15	0.83	0.83	0.18	0.46	1.63	1.63	0.35	1.77	2.52	2.52	0.54	4.12	3.39	3.39	0.73	6.83	4.25	4.25	0.92	10.18
			17	0.83	0.83	0.18	0.46	1.63	1.63	0.35	1.78	2.52	2.52	0.54	4.13	3.39	3.39	0.73	6.85	4.26	4.26	0.92	10.21
			19	-	-	-	-	1.63	1.63	0.35	1.79	2.53	2.53	0.54	4.14	3.40	3.40	0.73	6.87	4.26	4.26	0.92	10.24
			20	-	-	-	-	1.63	1.60	0.35	1.77	2.53	2.53	0.54	4.15	3.40	3.40	0.73	6.88	4.27	4.27	0.92	10.25
	5	15	0.42	0.42	0.07	0.18	1.26	1.26	0.22	0.56	2.04	2.04	0.35	1.82	2.92	2.92	0.50	3.66	3.79	3.79	0.65	5.68	
		17	0.42	0.42	0.07	0.18	1.26	1.26	0.22	0.56	2.04	2.04	0.35	1.83	2.93	2.93	0.50	3.67	3.80	3.80	0.65	5.70	
		19	-	-	-	-	1.26	1.26	0.22	0.56	2.05	2.05	0.35	1.83	2.94	2.94	0.51	3.68	3.80	3.80	0.66	5.72	
		20	-	-	-	-	1.26	1.26	0.22	0.56	2.05	2.05	0.35	1.84	2.94	2.94	0.51	3.68	3.81	3.81	0.66	5.73	
	6	15	-	-	-	-	0.84	0.84	0.12	0.30	1.66	1.66	0.24	0.66	2.44	2.44	0.35	1.82	3.32	3.32	0.48	3.32	
		17	-	-	-	-	0.84	0.84	0.12	0.30	1.67	1.67	0.24	0.67	2.45	2.45	0.35	1.83	3.33	3.33	0.48	3.33	
		19	-	-	-	-	0.84	0.84	0.12	0.30	1.67	1.67	0.24	0.67	2.45	2.45	0.35	1.84	3.34	3.34	0.48	3.34	
		20	-	-	-	-	0.84	0.84	0.12	0.30	1.67	1.67	0.24	0.67	2.45	2.45	0.35	1.84	3.34	3.34	0.48	3.34	

EWT: Enter Water Temp. (°C) Δt: Temperature Difference (°C) DB: Dry Bulb Temp. (°C) WB: Wet Bulb Temp. (°C)
 TC: Total Cooling Capacity (kW) SC: Sensible Cooling Capacity (kW) WF: Water Flow (m³/h) WPD: Water Pressure Drop (kPa)

Cooling capacity

MDVF-1200D302E																						
EWT	ΔT	Indoor temp (W.B.)	Indoor temperature (D.B.)																			
			21				23				25				27				29			
			TC	SC	WF	WPD	TC	SC	WF	WPD	TC	SC	WF	WPD	TC	SC	WF	WPD	TC	SC	WF	WPD
°C	°C	°C	kW	kW	m³/h	kPa	kW	kW	m³/h	kPa	kW	kW	m³/h	kPa	kW	kW	m³/h	kPa	kW	kW	m³/h	kPa
5	3	15	8.65	6.81	2.50	76.15	8.58	7.85	2.48	75.01	8.87	8.87	2.54	78.56	9.88	9.88	2.84	95.12	10.90	10.90	3.16	114.73
		17	11.66	6.82	3.37	128.47	11.61	7.86	3.37	128.48	11.54	8.89	3.35	127.11	11.47	9.90	3.33	125.64	11.37	10.90	3.27	122.16
		19	-	-	-	-	14.83	7.86	4.28	195.53	14.75	8.89	4.26	193.63	14.67	9.91	4.23	191.81	14.60	10.92	4.21	190.07
		20	-	-	-	-	16.56	7.86	4.78	237.40	16.47	8.89	4.75	235.24	16.38	9.92	4.73	233.00	16.30	10.93	4.70	230.87
	4	15	7.38	6.24	1.58	34.25	7.48	7.29	1.60	35.05	8.32	8.32	1.79	42.18	9.34	9.34	2.01	51.65	10.35	10.35	2.24	62.43
		17	10.45	6.26	2.26	63.40	10.38	7.30	2.24	62.73	10.32	8.33	2.23	62.07	10.24	9.35	2.21	61.23	10.46	10.37	2.26	63.51
		19	-	-	-	-	13.63	7.31	2.95	101.37	13.56	8.34	2.94	100.38	13.48	9.37	2.92	99.41	13.41	10.38	2.90	98.43
		20	-	-	-	-	15.35	7.31	3.32	124.45	15.26	8.34	3.30	123.40	15.19	9.37	3.29	122.89	15.11	10.39	3.28	121.72
	5	15	6.18	5.70	1.06	17.18	6.75	6.75	1.16	20.05	7.77	7.77	1.33	25.32	8.80	8.80	1.52	31.65	9.81	9.81	1.69	38.23
		17	9.18	5.70	1.58	34.05	9.12	6.74	1.57	33.67	9.04	7.77	1.56	33.16	9.14	8.81	1.57	33.77	9.82	9.82	1.69	38.32
		19	-	-	-	-	12.36	6.75	2.13	57.01	12.29	7.78	2.12	56.42	12.21	8.80	2.10	55.54	12.13	9.82	2.08	54.95
		20	-	-	-	-	14.10	6.76	2.44	72.07	14.02	7.80	2.42	71.37	13.95	8.82	2.41	70.68	13.87	9.84	2.39	69.98
6	15	5.22	5.14	0.75	9.36	6.19	6.19	0.89	12.56	7.23	7.23	1.04	16.37	8.24	8.24	1.18	20.40	9.26	9.26	1.32	24.93	
	17	7.84	5.13	1.12	18.69	7.77	6.17	1.11	18.39	7.79	7.22	1.11	18.50	8.31	8.26	1.19	20.67	9.28	9.28	1.33	24.99	
	19	-	-	-	-	11.08	6.20	1.59	34.17	11.01	7.24	1.58	33.82	10.94	8.27	1.57	33.46	10.85	9.28	1.56	32.99	
	20	-	-	-	-	12.80	6.20	1.84	43.95	12.72	7.24	1.83	43.50	12.65	8.27	1.82	43.07	12.58	9.29	1.81	42.63	
7	3	15	6.30	5.76	1.81	42.68	6.81	6.80	1.96	48.91	7.84	7.84	2.26	63.14	8.86	8.86	2.55	77.74	9.87	9.87	2.85	94.18
		17	9.36	5.78	2.72	86.80	9.30	6.82	2.70	85.85	9.23	7.85	2.68	84.74	9.21	8.88	2.67	84.33	9.88	9.88	2.85	94.43
		19	-	-	-	-	12.54	6.82	3.64	144.79	12.46	7.86	3.61	142.80	12.39	8.88	3.59	141.28	12.33	9.90	3.58	140.98
		20	-	-	-	-	14.27	6.83	4.17	183.87	14.20	7.87	4.14	182.12	14.12	8.91	4.12	180.49	14.04	9.92	4.10	178.65
	4	15	5.31	5.22	1.14	19.17	6.26	6.26	1.35	25.50	7.30	7.30	1.58	33.62	8.33	8.33	1.80	42.22	9.34	9.34	2.02	51.58
		17	8.03	5.21	1.73	39.28	7.97	6.26	1.71	38.72	7.92	7.29	1.71	38.36	8.37	8.34	1.81	42.61	9.35	9.35	2.03	51.72
		19	-	-	-	-	11.25	6.27	2.43	71.26	11.18	7.31	2.42	70.49	11.11	8.34	2.40	69.75	11.02	9.35	2.38	68.70
		20	-	-	-	-	12.98	6.28	2.82	92.12	12.91	7.32	2.80	91.22	12.84	8.35	2.79	90.28	12.76	9.37	2.77	89.34
	5	15	4.66	4.65	0.80	10.41	5.71	5.71	0.98	14.76	6.75	6.75	1.16	19.63	7.78	7.78	1.34	25.08	8.80	8.80	1.52	31.32
		17	6.68	4.66	1.15	19.27	6.62	5.70	1.14	18.98	6.93	6.76	1.19	20.53	7.79	7.79	1.34	25.14	8.82	8.82	1.52	31.41
		19	-	-	-	-	9.90	5.71	1.70	38.09	9.83	6.75	1.69	37.67	9.85	8.19	1.77	59.62	9.70	8.80	1.67	36.80
		20	-	-	-	-	11.65	5.73	2.01	51.00	11.58	6.77	2.00	50.46	11.51	7.80	1.99	49.93	11.43	8.82	1.98	49.35
6	15	4.09	4.09	0.59	6.07	5.16	5.16	0.74	9.01	6.20	6.20	0.89	12.36	7.24	7.24	1.04	16.11	8.26	8.26	1.19	20.28	
	17	5.23	4.09	0.75	9.23	5.46	5.16	0.78	9.94	6.22	6.21	0.89	12.40	7.25	7.25	1.04	16.15	8.27	8.27	1.19	20.34	
	19	-	-	-	-	8.53	5.17	1.22	21.41	8.45	6.21	1.21	21.09	8.39	7.24	1.21	20.83	8.63	8.28	1.24	21.88	
	20	-	-	-	-	10.24	5.17	1.47	29.28	10.17	6.21	1.46	28.95	10.10	7.24	1.45	28.61	10.01	8.27	1.44	28.18	
9	3	15	4.73	4.73	1.36	25.61	5.77	5.77	1.66	36.19	6.81	6.81	1.97	49.00	7.84	7.84	2.27	62.69	8.85	8.85	2.55	76.67
		17	6.88	4.73	1.99	49.78	6.80	5.78	1.97	48.84	6.95	6.83	2.01	50.74	7.85	7.85	2.28	62.73	8.86	8.86	2.55	76.79
		19	-	-	-	-	10.05	5.78	2.90	96.12	9.99	6.82	2.88	95.02	9.93	7.85	2.87	94.28	9.86	8.88	2.87	94.13
		20	-	-	-	-	11.80	5.79	3.44	129.16	11.74	6.83	3.42	128.40	11.67	7.87	3.40	127.01	11.60	8.89	3.38	125.59
	4	15	4.18	4.18	0.90	12.54	5.23	5.23	1.13	18.53	6.27	6.27	1.36	25.47	7.29	7.29	1.57	32.76	8.32	8.32	1.80	41.64
		17	5.46	4.17	1.18	19.90	5.55	5.24	1.20	20.48	6.28	6.27	1.36	25.52	7.30	7.30	1.57	32.84	8.33	8.33	1.81	41.75
		19	-	-	-	-	8.71	5.24	1.89	45.05	8.65	6.28	1.87	44.50	8.56	7.31	1.86	43.77	8.67	8.35	1.88	44.71
		20	-	-	-	-	10.40	5.23	2.24	60.90	10.33	6.27	2.23	60.22	10.27	7.31	2.21	59.57	10.18	8.33	2.20	58.74
	5	15	3.62	3.62	0.62	6.65	4.68	4.68	0.81	10.33	5.73	5.73	0.99	14.67	6.76	6.76	1.16	19.41	7.78	7.78	1.34	24.77
		17	4.05	3.61	0.70	8.05	4.71	4.69	0.81	10.46	5.74	5.74	0.99	14.70	6.77	6.77	1.17	19.47	7.79	7.79	1.34	24.84
		19	-	-	-	-	7.26	4.68	1.25	21.94	7.18	5.72	1.24	21.53	7.27	6.77	1.25	22.00	7.85	7.81	1.35	25.14
		20	-	-	-	-	8.98	4.68	1.55	31.76	8.92	5.73	1.54	31.38	8.84	6.76	1.52	30.90	8.79	7.79	1.51	30.60
6	15	3.03	3.03	0.43	3.45	4.12	4.12	0.59	6.05	5.18	5.18	0.74	8.94	6.22	6.22	0.89	12.24	7.25	7.25	1.04	15.91	
	17	3.06	3.04	0.44	3.54	4.12	4.12	0.59	6.07	5.19	5.19	0.74	8.97	6.23	6.23	0.89	12.27	7.26	7.26	1.04	15.95	
	19	-	-	-	-	5.72	4.12	0.82	10.60	5.80	5.18	0.83	10.84	6.36	6.24	0.91	12.71	7.27	7.27	1.04	15.99	
	20	-	-	-	-	7.50	4.13	1.08	16.88	7.42	5.18	1.07	16.57	7.38	6.22	1.06	16.40	7.66	7.27	1.10	17.50	

Continued:

MDVF-1200D302E																							
EWT	ΔT	Indoor temp (W.B.)	Indoor temperature (D.B.)																				
			21				23				25				27				29				
°C	°C	°C	TC	SC	WF	WPD	TC	SC	WF	WPD	TC	SC	WF	WPD	TC	SC	WF	WPD	TC	SC	WF	WPD	
			kW	kW	m³/h	kPa	kW	kW	m³/h	kPa	kW	kW	m³/h	kPa	kW	kW	m³/h	kPa	kW	kW	m³/h	kPa	
11	3	15	3.68	3.68	1.05	16.19	4.73	4.73	1.35	24.99	5.78	5.78	1.66	35.54	6.80	6.80	1.94	46.98	7.82	7.82	2.24	60.07	
		17	4.18	3.68	1.19	20.17	4.74	4.74	1.35	25.09	5.78	5.78	1.66	35.63	6.81	6.81	1.95	47.11	7.83	7.83	2.24	60.22	
		19	-	-	-	-	7.41	4.74	2.13	55.03	7.35	5.79	2.12	54.59	7.33	6.82	2.11	54.27	7.85	7.84	2.25	60.44	
		20	-	-	-	-	9.12	4.73	2.61	78.88	9.06	5.78	2.60	77.94	8.99	6.81	2.58	76.86	8.91	7.84	2.55	75.60	
	4	15	3.13	3.13	0.67	7.46	4.19	4.19	0.90	12.29	5.23	5.23	1.12	18.02	6.27	6.27	1.34	24.62	7.29	7.29	1.57	32.21	
		17	3.18	3.14	0.68	7.65	4.20	4.20	0.90	12.32	5.24	5.24	1.12	18.07	6.28	6.28	1.35	24.68	7.31	7.31	1.57	32.30	
		19	-	-	-	-	5.90	4.18	1.26	22.18	5.89	5.23	1.26	22.11	6.36	6.29	1.36	25.28	7.32	7.32	1.57	32.39	
		20	-	-	-	-	7.69	4.20	1.66	35.47	7.62	5.25	1.64	34.92	7.55	6.28	1.63	34.31	7.68	7.33	1.66	35.41	
	5	15	2.55	2.55	0.44	3.57	3.64	3.64	0.63	6.63	4.70	4.70	0.81	10.25	5.73	5.73	0.98	14.29	6.77	6.77	1.17	19.21	
		17	2.55	2.55	0.44	3.58	3.65	3.65	0.63	6.65	4.71	4.71	0.81	10.28	5.74	5.74	0.98	14.33	6.78	6.78	1.17	19.26	
		19	-	-	-	-	4.39	3.63	0.76	9.13	4.87	4.72	0.84	10.88	5.75	5.74	0.99	14.37	6.79	6.79	1.17	19.31	
		20	-	-	-	-	6.14	3.65	1.06	16.23	6.07	4.70	1.05	15.89	6.23	5.75	1.07	16.61	6.85	6.80	1.18	19.60	
	6	15	2.06	2.06	0.30	1.31	3.06	3.06	0.44	3.56	4.13	4.13	0.59	5.97	5.19	5.19	0.74	8.79	6.23	6.23	0.89	12.02	
		17	2.06	2.06	0.30	1.31	3.06	3.06	0.44	3.57	4.14	4.14	0.59	5.98	5.20	5.20	0.74	8.82	6.24	6.24	0.89	12.05	
		19	-	-	-	-	3.19	3.08	0.46	3.86	4.14	4.13	0.59	5.99	5.21	5.21	0.74	8.84	6.25	6.25	0.89	12.08	
		20	-	-	-	-	4.43	3.06	0.63	6.71	4.62	4.14	0.66	7.20	5.30	5.21	0.76	9.12	6.25	6.25	0.89	12.10	
	13	3	15	2.64	2.64	0.76	9.10	3.70	3.70	1.06	16.26	4.74	4.74	1.36	25.01	5.77	5.77	1.65	34.78	6.80	6.80	1.96	47.00
			17	2.64	2.64	0.76	9.12	3.70	3.70	1.06	16.30	4.75	4.75	1.37	25.08	5.77	5.77	1.65	34.87	6.81	6.81	1.96	47.12
			19	-	-	-	-	4.53	3.69	1.30	23.12	4.85	4.76	1.40	26.04	5.78	5.78	1.65	34.97	6.82	6.82	1.97	47.26
			20	-	-	-	-	6.27	3.69	1.80	40.50	6.19	4.74	1.77	39.36	6.21	5.79	1.78	39.70	6.83	6.83	1.97	47.38
		4	15	2.06	2.06	0.44	3.63	3.14	3.14	0.67	7.38	4.19	4.19	0.90	12.14	5.24	5.24	1.13	18.00	6.27	6.27	1.35	24.54
			17	2.06	2.06	0.44	3.64	3.14	3.14	0.67	7.40	4.20	4.20	0.90	12.17	5.25	5.25	1.13	18.05	6.28	6.28	1.35	24.61
			19	-	-	-	-	3.28	3.15	0.70	7.98	4.20	4.19	0.90	12.19	5.26	5.26	1.13	18.10	6.29	6.29	1.36	24.68
			20	-	-	-	-	4.68	3.14	1.01	14.77	4.72	4.21	1.02	15.02	5.32	5.27	1.15	18.46	6.29	6.29	1.36	24.71
5		15	1.56	1.56	0.27	1.03	2.56	2.56	0.44	3.57	3.65	3.65	0.63	6.51	4.70	4.70	0.81	10.04	5.74	5.74	0.98	14.13	
		17	1.56	1.56	0.27	1.03	2.57	2.57	0.44	3.58	3.65	3.65	0.63	6.52	4.71	4.71	0.81	10.06	5.75	5.75	0.99	14.17	
		19	-	-	-	-	2.57	2.56	0.44	3.58	3.66	3.66	0.63	6.54	4.72	4.72	0.81	10.09	5.76	5.76	0.99	14.21	
		20	-	-	-	-	3.00	2.57	0.52	4.67	3.73	3.67	0.64	6.77	4.72	4.71	0.81	10.10	5.76	5.76	0.99	14.24	
6		15	1.07	1.07	0.15	0.48	2.06	2.06	0.29	1.34	3.08	3.08	0.44	3.56	4.16	4.16	0.59	5.94	5.20	5.20	0.74	8.71	
		17	0.49	0.49	0.03	0.08	2.06	2.06	0.29	1.35	3.08	3.08	0.44	3.57	4.16	4.16	0.60	5.95	5.21	5.21	0.75	8.74	
		19	-	-	-	-	2.06	2.06	0.30	1.35	3.09	3.09	0.44	3.58	4.17	4.17	0.60	5.97	5.22	5.22	0.75	8.76	
		20	-	-	-	-	2.11	2.07	0.30	1.44	3.09	3.09	0.44	3.59	4.17	4.17	0.60	5.98	5.23	5.23	0.75	8.78	
15		3	15	1.55	1.55	0.44	3.59	2.63	2.63	0.75	8.85	3.70	3.70	1.06	16.06	4.73	4.73	1.35	24.26	5.76	5.76	1.65	34.25
			17	1.55	1.55	0.44	3.60	2.64	2.64	0.75	8.87	3.70	3.70	1.06	16.10	4.73	4.73	1.35	24.32	5.77	5.77	1.65	34.34
			19	-	-	-	-	2.64	2.63	0.75	8.88	3.71	3.71	1.07	16.15	4.74	4.74	1.35	24.39	5.78	5.78	1.65	34.44
			20	-	-	-	-	3.16	2.63	0.90	12.08	3.74	3.73	1.08	16.40	4.74	4.74	1.36	24.43	5.78	5.78	1.65	34.49
		4	15	1.06	1.06	0.23	0.73	2.07	2.07	0.44	3.59	3.15	3.15	0.68	7.33	4.21	4.21	0.91	12.16	5.23	5.23	1.12	17.55
			17	1.06	1.06	0.23	0.73	2.07	2.07	0.44	3.60	3.16	3.16	0.68	7.35	4.22	4.22	0.91	12.20	5.24	5.24	1.12	17.60
			19	-	-	-	-	2.08	2.08	0.45	3.61	3.16	3.16	0.68	7.37	4.22	4.22	0.91	12.23	5.25	5.25	1.13	17.65
			20	-	-	-	-	2.09	2.09	0.45	3.66	3.16	3.16	0.68	7.38	4.23	4.23	0.91	12.25	5.25	5.25	1.13	17.67
	5	15	0.55	0.55	0.10	0.29	1.57	1.57	0.27	1.09	2.59	2.59	0.45	3.62	3.67	3.67	0.63	6.52	4.71	4.71	0.81	10.02	
		17	0.55	0.55	0.10	0.29	1.57	1.57	0.27	1.09	2.60	2.60	0.45	3.63	3.67	3.67	0.63	6.54	4.72	4.72	0.81	10.05	
		19	-	-	-	-	1.57	1.57	0.27	1.10	2.60	2.60	0.45	3.64	3.68	3.68	0.63	6.56	4.73	4.73	0.82	10.08	
		20	-	-	-	-	1.57	1.57	0.27	1.10	2.61	2.61	0.45	3.65	3.68	3.68	0.63	6.57	4.73	4.73	0.82	10.10	
	6	15	-	-	-	-	1.08	1.08	0.16	0.47	2.06	2.06	0.30	1.42	3.11	3.11	0.45	3.59	4.18	4.18	0.60	5.94	
		17	-	-	-	-	1.08	1.08	0.16	0.47	2.07	2.07	0.30	1.42	3.11	3.11	0.45	3.60	4.18	4.18	0.60	5.95	
		19	-	-	-	-	1.08	1.08	0.16	0.47	2.07	2.07	0.30	1.43	3.12	3.12	0.45	3.61	4.19	4.19	0.60	5.97	
		20	-	-	-	-	1.08	1.08	0.16	0.47	2.07	2.07	0.30	1.43	3.12	3.12	0.45	3.62	4.19	4.19	0.60	5.98	

EWT: Enter Water Temp. (°C) Δt: Temperature Difference (°C) DB: Dry Bulb Temp. (°C) WB: Wet Bulb Temp. (°C)
 TC: Total Cooling Capacity (kW) SC: Sensible Cooling Capacity (kW) WF: Water Flow (m³/h) WPD: Water Pressure Drop (kPa)

Cooling capacity

MDVF-1400D302E																						
EWT	ΔT	Indoor temp (W.B.)	Indoor temperature (D.B.)																			
			21				23				25				27				29			
			TC	SC	WF	WPD	TC	SC	WF	WPD	TC	SC	WF	WPD	TC	SC	WF	WPD	TC	SC	WF	WPD
°C	°C	°C	kW	kW	m ³ /h	kPa	kW	kW	m ³ /h	kPa	kW	kW	m ³ /h	kPa	kW	kW	m ³ /h	kPa	kW	kW	m ³ /h	kPa
5	3	15	9.53	7.46	2.74	98.22	9.45	8.59	2.72	96.82	9.74	9.72	2.82	103.55	10.81	10.81	3.14	124.65	11.90	11.90	3.45	147.00
		17	12.82	7.48	3.70	166.46	12.74	8.60	3.68	164.72	12.67	9.72	3.66	163.09	12.58	10.81	3.63	161.06	12.50	11.90	3.61	159.21
		19	-	-	-	-	16.27	8.61	4.70	253.45	16.18	9.73	4.67	250.87	16.09	10.83	4.64	248.35	16.00	11.93	4.62	245.88
		20	-	-	-	-	18.15	8.62	5.24	307.49	18.05	9.74	5.21	304.47	17.95	10.85	5.18	301.43	17.85	11.94	5.15	298.46
	4	15	8.23	6.88	1.77	45.58	8.31	8.01	1.78	46.37	9.13	9.13	1.97	54.91	10.22	10.22	2.20	66.60	11.31	11.31	2.43	79.60
		17	11.54	6.89	2.48	82.34	11.46	8.02	2.47	81.41	11.38	9.13	2.45	80.43	11.30	10.23	2.43	79.36	11.50	11.34	2.47	81.87
		19	-	-	-	-	15.03	8.04	3.26	132.80	14.91	9.15	3.22	129.72	14.83	10.26	3.20	128.32	14.74	11.35	3.18	126.99
		20	-	-	-	-	16.90	8.05	3.67	163.51	16.80	9.17	3.65	161.87	16.71	10.28	3.63	160.24	16.61	11.37	3.61	158.61
	5	15	6.94	6.29	1.19	22.92	7.48	7.44	1.28	26.09	8.56	8.56	1.48	33.20	9.66	9.66	1.66	40.86	10.75	10.75	1.85	48.95
		17	10.21	6.30	1.75	44.72	10.14	7.43	1.74	44.20	10.05	8.54	1.73	43.54	10.13	9.66	1.74	44.15	10.77	10.77	1.85	49.14
		19	-	-	-	-	13.68	7.44	2.35	74.65	13.60	8.57	2.34	73.86	13.53	9.68	2.33	73.48	13.46	10.78	2.32	73.03
		20	-	-	-	-	15.56	7.45	2.68	93.65	15.47	8.57	2.66	92.65	15.37	9.68	2.65	91.66	15.28	10.79	2.63	90.70
6	15	5.93	5.73	0.85	12.84	6.86	6.86	0.98	16.46	7.97	7.97	1.14	21.19	9.08	9.08	1.30	26.52	10.19	10.19	1.46	32.56	
	17	8.84	5.71	1.26	25.29	8.76	6.84	1.25	24.87	8.77	7.97	1.25	24.93	9.24	9.10	1.32	27.31	10.21	10.21	1.47	32.65	
	19	-	-	-	-	12.35	6.87	1.77	45.44	12.27	8.00	1.76	44.93	12.19	9.11	1.75	44.41	12.09	10.21	1.74	43.77	
	20	-	-	-	-	14.19	6.87	2.03	57.57	14.11	7.99	2.02	56.95	14.02	9.11	2.01	56.35	13.93	10.21	2.00	55.72	
7	3	15	7.02	6.34	2.02	57.16	7.47	7.47	2.15	63.44	8.58	8.58	2.47	80.96	9.69	9.69	2.82	101.83	10.79	10.79	3.14	123.24
		17	10.31	6.34	2.98	112.02	10.25	7.47	2.97	111.41	10.15	8.58	2.93	109.03	10.13	9.70	2.92	108.66	10.80	10.80	3.15	123.53
		19	-	-	-	-	13.79	7.49	4.02	190.50	13.71	8.61	4.00	188.49	13.63	9.72	3.98	186.49	13.55	10.82	3.95	184.48
		20	-	-	-	-	15.66	7.50	4.57	238.43	15.57	8.62	4.54	236.00	15.48	9.73	4.52	233.53	15.39	10.83	4.49	231.08
	4	15	5.93	5.76	1.28	25.53	6.90	6.90	1.49	33.52	8.02	8.02	1.74	43.51	9.12	9.12	1.98	54.51	10.21	10.21	2.20	65.77
		17	8.96	5.77	1.94	52.87	8.89	6.89	1.92	52.05	8.84	8.02	1.91	51.54	9.22	9.14	2.00	55.56	10.22	10.22	2.20	65.96
		19	-	-	-	-	12.44	6.91	2.70	94.14	12.36	8.03	2.68	93.06	12.29	9.15	2.67	92.09	12.20	10.25	2.65	90.84
		20	-	-	-	-	14.32	6.92	3.11	120.68	14.23	8.04	3.10	119.52	14.15	9.16	3.08	118.23	14.06	10.26	3.06	116.95
	5	15	5.18	5.18	0.89	13.71	6.31	6.31	1.09	19.25	7.43	7.43	1.28	25.54	8.54	8.54	1.47	32.49	9.64	9.64	1.66	40.10
		17	7.51	5.17	1.29	25.99	7.45	6.30	1.28	25.62	7.75	7.46	1.34	27.65	8.56	8.55	1.47	32.57	9.66	9.66	1.66	40.22
		19	-	-	-	-	11.04	6.33	1.91	51.12	10.97	7.45	1.90	50.53	10.89	8.85	1.96	60.90	10.81	9.67	1.87	49.31
		20	-	-	-	-	12.89	6.32	2.22	66.55	12.80	7.45	2.21	65.79	12.72	8.57	2.19	65.05	12.63	9.67	2.18	64.17
6	15	4.58	4.58	0.66	8.10	5.73	5.73	0.82	11.87	6.86	6.86	0.98	16.18	7.98	7.98	1.15	21.03	9.09	9.09	1.31	26.41	
	17	6.01	4.57	0.86	12.86	6.23	5.74	0.90	13.79	6.92	6.88	0.99	16.41	7.99	7.99	1.15	21.09	9.10	9.10	1.31	26.48	
	19	-	-	-	-	9.55	5.73	1.37	28.57	9.46	6.86	1.36	28.11	9.42	7.98	1.35	27.92	9.63	9.10	1.38	28.98	
	20	-	-	-	-	11.44	5.74	1.64	39.10	11.37	6.87	1.63	38.64	11.28	7.99	1.62	38.15	11.18	9.10	1.60	37.58	
9	3	15	5.20	5.19	1.49	33.22	6.34	6.34	1.84	47.59	7.46	7.46	2.15	62.78	8.56	8.56	2.47	79.65	9.66	9.66	2.79	98.54
		17	7.60	5.20	2.19	64.49	7.52	6.33	2.16	63.27	7.66	7.47	2.21	65.44	8.58	8.58	2.47	79.89	9.69	9.69	2.82	100.43
		19	-	-	-	-	11.12	6.36	3.24	128.39	11.04	7.48	3.22	126.82	10.94	8.59	3.18	123.75	10.86	9.70	3.17	123.23
		20	-	-	-	-	12.96	6.35	3.76	166.56	12.88	7.48	3.74	164.78	12.80	8.60	3.71	162.86	12.71	9.70	3.69	160.95
	4	15	4.63	4.63	1.00	16.45	5.77	5.77	1.25	24.25	6.88	6.88	1.48	32.61	8.01	8.01	1.74	42.87	9.11	9.11	1.98	53.69
		17	6.14	4.62	1.33	27.00	6.22	5.77	1.35	27.61	6.90	6.90	1.49	32.77	8.02	8.02	1.74	42.99	9.12	9.12	1.98	53.85
		19	-	-	-	-	9.63	5.76	2.08	58.67	9.57	6.89	2.07	58.15	9.50	8.02	2.06	57.79	9.58	9.13	2.07	58.13
		20	-	-	-	-	11.51	5.77	2.49	80.28	11.43	6.90	2.47	79.28	11.35	8.02	2.45	78.32	11.26	9.12	2.43	77.18
	5	15	4.04	4.04	0.69	8.82	5.18	5.18	0.89	13.54	6.32	6.32	1.09	19.01	7.43	7.43	1.28	25.19	8.54	8.54	1.47	32.01
		17	4.66	4.03	0.80	11.25	5.30	5.21	0.92	14.13	6.33	6.33	1.09	19.07	7.45	7.45	1.28	25.27	8.55	8.55	1.47	32.10
		19	-	-	-	-	8.13	5.18	1.40	29.39	8.05	6.31	1.39	28.87	8.13	7.45	1.40	29.37	8.68	8.57	1.50	32.94
		20	-	-	-	-	10.05	5.20	1.74	42.82	9.98	6.33	1.73	42.28	9.88	7.45	1.71	41.59	9.83	8.57	1.70	41.20
6	15	3.42	3.42	0.49	4.86	4.60	4.60	0.66	8.03	5.74	5.74	0.82	11.74	6.86	6.86	0.98	15.95	7.98	7.98	1.14	20.66	
	17	3.55	3.44	0.51	5.17	4.60	4.59	0.66	8.05	5.75	5.75	0.82	11.77	6.88	6.88	0.99	15.99	7.99	7.99	1.15	20.72	
	19	-	-	-	-	6.53	4.59	0.94	14.63	6.59	5.74	0.95	14.86	7.13	6.89	1.02	17.00	8.00	8.00	1.15	20.78	
	20	-	-	-	-	8.46	4.61	1.21	22.84	8.37	5.74	1.20	22.41	8.32	6.86	1.19	22.19	8.59	8.00	1.23	23.45	

Continued:

MDVF-1400D302E																							
EWT	ΔT	Indoor temp (W.B.)	Indoor temperature (D.B.)																				
			21				23				25				27				29				
°C	°C	°C	TC	SC	WF	WPD	TC	SC	WF	WPD	TC	SC	WF	WPD	TC	SC	WF	WPD	TC	SC	WF	WPD	
			kW	kW	m³/h	kPa	kW	kW	m³/h	kPa	kW	kW	m³/h	kPa	kW	kW	m³/h	kPa	kW	kW	m³/h	kPa	
11	3	15	4.06	4.06	1.16	21.11	5.20	5.20	1.48	32.38	6.32	6.32	1.81	45.57	7.44	7.44	2.13	60.59	8.54	8.54	2.45	77.41	
		17	4.71	4.06	1.35	27.30	5.23	5.22	1.49	32.75	6.33	6.33	1.81	45.70	7.45	7.45	2.13	60.77	8.56	8.56	2.45	77.62	
		19	-	-	-	-	8.22	5.21	2.37	73.22	8.14	6.34	2.35	71.87	8.12	7.47	2.34	71.51	8.60	8.58	2.46	78.27	
		20	-	-	-	-	10.11	5.22	2.92	105.63	10.03	6.35	2.90	104.29	9.95	7.47	2.88	102.74	9.85	8.58	2.84	100.66	
	4	15	3.48	3.48	0.75	9.84	4.63	4.63	0.99	16.03	5.76	5.76	1.23	23.40	6.88	6.88	1.48	32.05	7.98	7.98	1.71	41.31	
		17	3.59	3.49	0.77	10.39	4.63	4.63	0.99	16.07	5.77	5.77	1.24	23.46	6.89	6.89	1.48	32.14	8.00	8.00	1.72	41.43	
		19	-	-	-	-	6.63	4.63	1.42	29.95	6.61	5.76	1.42	29.83	7.07	6.92	1.52	33.69	8.01	8.01	1.72	41.55	
		20	-	-	-	-	8.53	4.63	1.83	46.34	8.44	5.76	1.81	45.52	8.36	6.89	1.79	44.78	8.50	8.02	1.82	46.08	
	5	15	2.88	2.88	0.50	4.90	4.05	4.05	0.70	8.75	5.18	5.18	0.89	13.24	6.32	6.32	1.09	18.79	7.44	7.44	1.28	24.86	
		17	2.88	2.87	0.50	4.91	4.06	4.06	0.70	8.78	5.19	5.19	0.89	13.28	6.33	6.33	1.09	18.84	7.45	7.45	1.28	24.93	
		19	-	-	-	-	5.03	4.04	0.87	12.66	5.47	5.20	0.94	14.51	6.35	6.35	1.09	18.92	7.46	7.46	1.29	25.01	
		20	-	-	-	-	6.92	4.05	1.19	21.93	6.85	5.19	1.18	21.54	6.99	6.34	1.21	22.35	7.60	7.47	1.31	25.79	
	6	15	2.30	2.30	0.33	1.95	3.45	3.45	0.49	4.86	4.60	4.60	0.66	7.88	5.74	5.74	0.82	11.50	6.87	6.87	0.99	15.77	
		17	2.30	2.30	0.33	1.96	3.45	3.45	0.50	4.87	4.61	4.61	0.66	7.91	5.75	5.75	0.82	11.54	6.89	6.89	0.99	15.81	
		19	-	-	-	-	3.72	3.45	0.53	5.47	4.64	4.63	0.66	8.00	5.76	5.76	0.82	11.58	6.90	6.90	0.99	15.86	
		20	-	-	-	-	5.15	3.44	0.74	9.52	5.31	4.61	0.76	10.04	5.97	5.77	0.85	12.29	6.91	6.90	0.99	15.90	
	13	3	15	2.92	2.92	0.84	11.92	4.07	4.07	1.17	21.12	5.19	5.19	1.48	31.89	6.32	6.32	1.82	45.57	7.43	7.43	2.14	60.55
			17	2.92	2.92	0.84	11.95	4.07	4.07	1.17	21.18	5.20	5.20	1.49	31.98	6.34	6.34	1.82	45.70	7.45	7.45	2.15	60.73
			19	-	-	-	-	5.05	4.05	1.44	30.35	5.37	5.22	1.53	33.82	6.34	6.34	1.83	45.83	7.46	7.46	2.15	60.92
			20	-	-	-	-	6.95	4.06	1.99	53.07	6.86	5.20	1.96	51.92	6.89	6.33	1.97	52.25	7.50	7.48	2.16	61.42
		4	15	2.32	2.32	0.50	4.90	3.48	3.48	0.75	9.70	4.63	4.63	1.00	16.02	5.76	5.76	1.24	23.31	6.86	6.86	1.47	31.32
			17	2.32	2.32	0.50	4.92	3.49	3.49	0.75	9.73	4.64	4.64	1.00	16.06	5.77	5.77	1.24	23.37	6.87	6.87	1.47	31.42
			19	-	-	-	-	3.72	3.50	0.80	10.89	4.65	4.64	1.00	16.11	5.78	5.78	1.25	23.45	6.89	6.89	1.48	31.51
			20	-	-	-	-	5.27	3.48	1.14	19.97	5.32	4.64	1.15	20.31	5.90	5.79	1.27	24.34	6.89	6.89	1.48	31.56
5		15	1.74	1.74	0.30	1.52	2.89	2.89	0.50	4.81	4.05	4.05	0.70	8.56	5.19	5.19	0.89	13.08	6.32	6.32	1.09	18.51	
		17	1.74	1.74	0.30	1.53	2.89	2.89	0.50	4.82	4.06	4.06	0.70	8.59	5.20	5.20	0.89	13.12	6.33	6.33	1.09	18.56	
		19	-	-	-	-	2.90	2.89	0.50	4.84	4.07	4.07	0.70	8.61	5.21	5.21	0.89	13.16	6.34	6.34	1.09	18.62	
		20	-	-	-	-	3.54	2.88	0.61	6.78	4.23	4.08	0.73	9.22	5.21	5.20	0.89	13.18	6.35	6.35	1.09	18.65	
6	15	1.21	1.21	0.17	0.60	2.30	2.30	0.33	2.00	3.46	3.46	0.50	4.78	4.62	4.62	0.66	7.81	5.76	5.76	0.83	11.47		
	17	1.21	1.21	0.17	0.60	2.30	2.30	0.33	2.01	3.47	3.47	0.50	4.80	4.62	4.62	0.66	7.83	5.77	5.77	0.83	11.51		
	19	-	-	-	-	2.31	2.31	0.33	2.02	3.47	3.47	0.50	4.81	4.63	4.63	0.66	7.86	5.78	5.78	0.83	11.54		
	20	-	-	-	-	2.40	2.31	0.34	2.24	3.47	3.46	0.50	4.82	4.64	4.64	0.66	7.87	5.79	5.79	0.83	11.56		
15	3	15	1.74	1.74	0.50	4.82	2.91	2.91	0.83	11.58	4.06	4.06	1.17	20.81	5.18	5.18	1.48	31.37	6.30	6.30	1.80	44.17	
		17	1.75	1.75	0.50	4.84	2.92	2.92	0.83	11.61	4.07	4.07	1.17	20.86	5.19	5.19	1.48	31.46	6.31	6.31	1.81	44.30	
		19	-	-	-	-	2.92	2.90	0.83	11.62	4.08	4.08	1.17	20.89	5.20	5.20	1.49	31.56	6.32	6.32	1.81	44.43	
		20	-	-	-	-	3.61	2.92	1.04	16.98	4.14	4.09	1.18	21.20	5.20	5.20	1.49	31.61	6.33	6.33	1.81	44.51	
	4	15	1.19	1.19	0.25	1.01	2.32	2.32	0.50	4.81	3.50	3.50	0.75	9.75	4.63	4.63	1.00	15.79	5.75	5.75	1.23	22.71	
		17	1.19	1.19	0.26	1.02	2.33	2.33	0.50	4.82	3.51	3.51	0.76	9.78	4.64	4.64	1.00	15.84	5.76	5.76	1.23	22.78	
		19	-	-	-	-	2.33	2.33	0.50	4.84	3.51	3.51	0.76	9.81	4.65	4.65	1.00	15.89	5.77	5.77	1.24	22.85	
		20	-	-	-	-	2.40	2.35	0.51	5.08	3.51	3.50	0.76	9.81	4.65	4.65	1.00	15.92	5.77	5.77	1.24	22.89	
	5	15	0.63	0.63	0.11	0.36	1.75	1.75	0.30	1.62	2.91	2.91	0.50	4.83	4.06	4.06	0.70	8.55	5.19	5.19	0.90	13.03	
		17	0.63	0.63	0.11	0.36	1.75	1.75	0.30	1.63	2.91	2.91	0.50	4.85	4.07	4.07	0.70	8.57	5.20	5.20	0.90	13.07	
		19	-	-	-	-	1.75	1.75	0.30	1.63	2.92	2.92	0.50	4.86	4.08	4.08	0.70	8.60	5.21	5.21	0.90	13.11	
		20	-	-	-	-	1.75	1.74	0.30	1.63	2.92	2.92	0.50	4.87	4.08	4.08	0.70	8.61	5.22	5.22	0.90	13.13	
6	15	-	-	-	-	1.22	1.22	0.18	0.58	2.31	2.31	0.33	2.11	3.48	3.48	0.50	4.78	4.62	4.62	0.66	7.70		
	17	-	-	-	-	1.22	1.22	0.18	0.58	2.31	2.31	0.33	2.12	3.48	3.48	0.50	4.80	4.62	4.62	0.66	7.72		
	19	-	-	-	-	1.22	1.22	0.18	0.58	2.32	2.32	0.33	2.13	3.49	3.49	0.50	4.81	4.63	4.63	0.66	7.75		
	20	-	-	-	-	1.23	1.23	0.18	0.58	2.32	2.32	0.33	2.14	3.49	3.49	0.50	4.82	4.64	4.64	0.66	7.76		

EWT: Enter Water Temp. (°C) Δt: Temperature Difference (°C) DB: Dry Bulb Temp. (°C) WB: Wet Bulb Temp. (°C)
 TC: Total Cooling Capacity (kW) SC: Sensible Cooling Capacity (kW) WF: Water Flow (m³/h) WPD: Water Pressure Drop (kPa)

Cooling capacity modification coefficient table:

Speed	200		300		400		500		600		800		1000		1200		1400	
	TC	SC	TC	SC	TC	SC	TC	SC	TC	SC	TC	SC	TC	SC	TC	SC	TC	SC
High	1	1	1	1	1	1	1	1	1	1	1	1	1	1	1	1	1	1
Med	0.87	0.84	0.86	0.82	0.86	0.83	0.85	0.81	0.83	0.79	0.84	0.8	0.86	0.82	0.85	0.81	0.85	0.81
Low	0.76	0.73	0.75	0.71	0.74	0.7	0.74	0.7	0.74	0.7	0.76	0.72	0.72	0.68	0.73	0.69	0.75	0.71

2-row Duct Heating Capacity

EWT: Enter Water Temp. (°C) **Δt:** Temperature Difference (°C) **DB:** Dry Bulb Temp. (°C) **WB:** Wet Bulb Temp. (°C)
TC: Total Cooling Capacity (kW) **SC:** Sensible Cooling Capacity (kW) **WF:** Water Flow (m³/h) **WPD:** Water Pressure Drop (kPa)

MDVF-200D302E													
EWT	ΔT	Indoor temperature (W.B.)											
		16			18			20			22		
		TH	WF	WPD	TH	WF	WPD	TH	WF	WPD	TH	WF	WPD
°C	°C	kW	m³/h	kPa	kW	m³/h	kPa	kW	m³/h	kPa	kW	m³/h	kPa
40	8	2.02	0.22	2.01	1.75	0.19	1.58	1.49	0.16	1.19	1.22	0.13	0.82
	10	1.74	0.15	1.07	1.47	0.13	0.75	1.22	0.11	0.46	0.98	0.08	0.26
	12	1.47	0.11	0.45	1.23	0.09	0.29	0.98	0.07	0.21	0.73	0.05	0.16
	14	1.23	0.08	0.23	0.97	0.06	0.18	0.73	0.04	0.14	0.48	0.03	0.09
	16	0.97	0.05	0.17	0.73	0.04	0.12	0.48	0.03	0.08	0.24	0.01	0.04
45	8	2.68	0.29	3.18	2.41	0.26	2.65	2.15	0.23	2.17	1.88	0.20	1.73
	10	2.41	0.21	1.82	2.14	0.18	1.49	1.88	0.16	1.19	1.61	0.14	0.91
	12	2.13	0.15	1.10	1.86	0.13	0.86	1.60	0.12	0.60	1.35	0.10	0.38
	14	1.85	0.11	0.58	1.60	0.10	0.39	1.36	0.08	0.26	1.11	0.07	0.19
	16	1.61	0.09	0.28	1.36	0.07	0.21	1.11	0.06	0.17	0.86	0.05	0.13
50	8	3.34	0.36	4.53	3.07	0.33	3.92	2.80	0.30	3.34	2.54	0.27	2.82
	10	3.08	0.27	2.70	2.81	0.24	2.31	2.54	0.22	1.94	2.27	0.20	1.61
	12	2.81	0.20	1.69	2.54	0.18	1.43	2.27	0.16	1.18	2.00	0.14	0.95
	14	2.53	0.16	1.10	2.26	0.14	0.91	1.98	0.12	0.71	1.72	0.11	0.51
	16	2.24	0.12	0.69	1.98	0.11	0.51	1.73	0.09	0.35	1.49	0.08	0.24
55	8	4.00	0.43	6.06	3.73	0.40	5.36	3.46	0.37	4.70	3.19	0.34	4.09
	10	3.74	0.32	3.70	3.47	0.30	3.24	3.20	0.28	2.82	2.93	0.25	2.42
	12	3.47	0.25	2.38	3.20	0.23	2.07	2.93	0.21	1.78	2.66	0.19	1.51
	14	3.20	0.20	1.61	2.93	0.18	1.38	2.66	0.16	1.17	2.39	0.15	0.98
	16	2.93	0.16	1.10	2.65	0.14	0.94	2.38	0.13	0.78	2.11	0.11	0.62
60	8	4.66	0.50	7.80	4.39	0.47	7.01	4.11	0.44	6.26	3.84	0.41	5.56
	10	4.40	0.38	4.78	4.12	0.36	4.27	3.85	0.33	3.79	3.58	0.31	3.35
	12	4.14	0.30	3.15	3.86	0.28	2.80	3.59	0.26	2.47	3.32	0.24	2.16
	14	3.87	0.24	2.17	3.60	0.22	1.91	3.33	0.20	1.67	3.06	0.19	1.45
	16	3.60	0.19	1.53	3.33	0.18	1.34	3.06	0.16	1.16	2.79	0.15	0.99

Heating capacity

MDVF-300D302E													
EWT	ΔT	Indoor temperature (W.B.)											
		16			18			20			22		
		TH	WF	WPD	TH	WF	WPD	TH	WF	WPD	TH	WF	WPD
°C	°C	kW	m³/h	kPa	kW	m³/h	kPa	kW	m³/h	kPa	kW	m³/h	kPa
40	8	2.69	0.29	3.88	2.34	0.25	3.06	1.99	0.21	2.32	1.64	0.18	1.68
	10	2.33	0.20	2.09	1.97	0.17	1.58	1.62	0.14	1.10	1.29	0.11	0.63
	12	1.95	0.14	1.10	1.61	0.12	0.69	1.30	0.09	0.39	0.98	0.07	0.25
	14	1.62	0.10	0.45	1.30	0.08	0.29	0.97	0.06	0.22	0.65	0.04	0.15
	16	1.30	0.07	0.26	0.97	0.05	0.20	0.65	0.03	0.13	0.32	0.02	0.07
45	8	3.56	0.38	6.13	3.21	0.35	5.13	2.86	0.31	4.21	2.51	0.27	3.37
	10	3.21	0.28	3.52	2.86	0.25	2.89	2.51	0.22	2.31	2.16	0.19	1.79
	12	2.85	0.21	2.13	2.50	0.18	1.70	2.15	0.15	1.32	1.79	0.13	0.94
	14	2.48	0.15	1.30	2.12	0.13	0.96	1.78	0.11	0.62	1.47	0.09	0.37
	16	2.11	0.11	0.68	1.80	0.10	0.44	1.48	0.08	0.28	1.15	0.06	0.21
50	8	4.43	0.48	8.76	4.07	0.44	7.58	3.72	0.40	6.48	3.37	0.36	5.47
	10	4.09	0.35	5.23	3.73	0.32	4.47	3.38	0.29	3.77	3.03	0.26	3.13
	12	3.74	0.27	3.28	3.38	0.24	2.77	3.03	0.22	2.30	2.68	0.19	1.86
	14	3.38	0.21	2.14	3.02	0.19	1.77	2.67	0.16	1.44	2.32	0.14	1.13
	16	3.02	0.16	1.42	2.66	0.14	1.15	2.30	0.12	0.87	1.96	0.11	0.59
55	8	5.29	0.57	11.74	4.94	0.53	10.39	4.58	0.49	9.12	4.23	0.46	7.94
	10	4.96	0.43	7.16	4.60	0.40	6.29	4.25	0.37	5.48	3.90	0.34	4.72
	12	4.61	0.33	4.62	4.26	0.31	4.02	3.91	0.28	3.46	3.56	0.26	2.95
	14	4.27	0.26	3.13	3.92	0.24	2.69	3.56	0.22	2.29	3.21	0.20	1.92
	16	3.92	0.21	2.15	3.56	0.19	1.83	3.20	0.17	1.53	2.85	0.15	1.25
60	8	6.17	0.67	15.14	5.80	0.63	13.54	5.45	0.59	12.11	5.09	0.55	10.76
	10	5.83	0.50	9.27	5.47	0.47	8.30	5.11	0.44	7.38	4.76	0.41	6.51
	12	5.49	0.40	6.13	5.13	0.37	5.45	4.78	0.34	4.82	4.42	0.32	4.22
	14	5.15	0.32	4.21	4.79	0.30	3.72	4.44	0.27	3.26	4.08	0.25	2.82
	16	4.80	0.26	2.98	4.45	0.24	2.61	4.09	0.22	2.27	3.74	0.20	1.94

Heating capacity

MDVF-400D302E													
EWT	ΔT	Indoor temperature (W.B.)											
		16			18			20			22		
		TH	WF	WPD	TH	WF	WPD	TH	WF	WPD	TH	WF	WPD
°C	°C	kW	m ³ /h	kPa	kW	m ³ /h	kPa	kW	m ³ /h	kPa	kW	m ³ /h	kPa
40	8	3.20	0.35	6.07	2.79	0.30	4.80	2.38	0.26	3.66	1.98	0.21	2.66
	10	2.79	0.24	3.29	2.37	0.20	2.51	1.96	0.17	1.81	1.54	0.13	1.14
	12	2.35	0.17	1.83	1.93	0.14	1.26	1.54	0.11	0.71	1.18	0.08	0.36
	14	1.92	0.12	0.82	1.56	0.10	0.47	1.18	0.07	0.30	0.79	0.05	0.20
	16	1.57	0.08	0.38	1.18	0.06	0.28	0.79	0.04	0.19	0.40	0.02	0.10
45	8	4.23	0.46	9.59	3.82	0.41	8.03	3.41	0.37	6.60	3.00	0.32	5.30
	10	3.83	0.33	5.52	3.41	0.29	4.54	3.00	0.26	3.64	2.59	0.22	2.83
	12	3.42	0.25	3.36	3.00	0.22	2.69	2.59	0.19	2.09	2.17	0.16	1.55
	14	2.99	0.18	2.07	2.57	0.16	1.60	2.14	0.13	1.14	1.75	0.11	0.68
	16	2.54	0.14	1.22	2.14	0.12	0.81	1.77	0.10	0.48	1.39	0.08	0.30
50	8	5.25	0.57	13.69	4.84	0.52	11.86	4.42	0.48	10.15	4.01	0.43	8.57
	10	4.86	0.42	8.18	4.45	0.38	7.01	4.03	0.35	5.93	3.62	0.31	4.92
	12	4.46	0.32	5.15	4.04	0.29	4.35	3.63	0.26	3.62	3.22	0.23	2.95
	14	4.05	0.25	3.38	3.63	0.22	2.80	3.22	0.20	2.28	2.80	0.17	1.80
	16	3.63	0.20	2.25	3.21	0.17	1.83	2.79	0.15	1.44	2.36	0.13	1.07
55	8	6.27	0.68	18.44	5.86	0.63	16.33	5.44	0.59	14.36	5.02	0.54	12.44
	10	5.89	0.51	11.20	5.47	0.47	9.85	5.06	0.44	8.58	4.64	0.40	7.40
	12	5.49	0.39	7.23	5.07	0.36	6.31	4.66	0.33	5.44	4.25	0.31	4.64
	14	5.10	0.31	4.91	4.68	0.29	4.24	4.26	0.26	3.61	3.85	0.24	3.03
	16	4.69	0.25	3.39	4.27	0.23	2.89	3.85	0.21	2.42	3.44	0.19	1.99
60	8	7.31	0.79	23.52	6.88	0.74	21.17	6.46	0.70	18.95	6.05	0.65	16.95
	10	6.92	0.60	14.56	6.49	0.56	12.98	6.08	0.52	11.55	5.66	0.49	10.21
	12	6.53	0.47	9.60	6.11	0.44	8.55	5.69	0.41	7.56	5.27	0.38	6.63
	14	6.13	0.38	6.60	5.71	0.35	5.84	5.29	0.33	5.12	4.88	0.30	4.45
	16	5.74	0.31	4.71	5.32	0.29	4.13	4.90	0.26	3.58	4.48	0.24	3.07

Heating capacity

MDVF-500D302E													
EWT	ΔT	Indoor temperature (W.B.)											
		16			18			20			22		
		TH	WF	WPD	TH	WF	WPD	TH	WF	WPD	TH	WF	WPD
°C	°C	kW	m³/h	kPa	kW	m³/h	kPa	kW	m³/h	kPa	kW	m³/h	kPa
40	8	3.83	0.41	8.32	3.34	0.36	6.54	2.86	0.31	5.01	2.38	0.26	3.65
	10	3.35	0.29	4.51	2.86	0.25	3.45	2.37	0.21	2.51	1.88	0.16	1.69
	12	2.86	0.21	2.55	2.36	0.17	1.84	1.86	0.13	1.15	1.41	0.10	0.55
	14	2.33	0.14	1.33	1.86	0.11	0.75	1.43	0.09	0.39	0.96	0.06	0.25
	16	1.89	0.10	0.54	1.43	0.08	0.34	0.97	0.05	0.23	0.49	0.03	0.12
45	8	5.04	0.54	13.01	4.55	0.49	10.90	4.07	0.44	8.97	3.59	0.39	7.21
	10	4.57	0.39	7.52	4.09	0.35	6.19	3.60	0.31	4.98	3.12	0.27	3.88
	12	4.10	0.30	4.60	3.61	0.26	3.70	3.12	0.23	2.88	2.63	0.19	2.16
	14	3.61	0.22	2.85	3.11	0.19	2.22	2.62	0.16	1.65	2.11	0.13	1.10
	16	3.10	0.17	1.78	2.60	0.14	1.28	2.12	0.11	0.78	1.68	0.09	0.42
50	8	6.25	0.67	18.55	5.76	0.62	16.08	5.27	0.57	13.77	4.79	0.52	11.64
	10	5.79	0.50	11.11	5.30	0.46	9.53	4.82	0.42	8.06	4.33	0.37	6.70
	12	5.33	0.38	7.01	4.84	0.35	5.93	4.35	0.31	4.94	3.86	0.28	4.03
	14	4.86	0.30	4.61	4.36	0.27	3.84	3.87	0.24	3.13	3.38	0.21	2.48
	16	4.38	0.24	3.10	3.88	0.21	2.52	3.38	0.18	2.00	2.89	0.16	1.53
55	8	7.46	0.80	24.85	6.97	0.75	22.13	6.48	0.70	19.46	5.99	0.65	16.95
	10	7.01	0.60	15.12	6.51	0.56	13.30	6.02	0.52	11.65	5.54	0.48	10.06
	12	6.55	0.47	9.82	6.05	0.44	8.57	5.56	0.40	7.40	5.07	0.36	6.31
	14	6.09	0.38	6.68	5.60	0.35	5.77	5.10	0.31	4.92	4.61	0.28	4.14
	16	5.61	0.30	4.63	5.12	0.28	3.95	4.63	0.25	3.32	4.14	0.22	2.74
60	8	8.68	0.94	32.01	8.18	0.88	28.76	7.68	0.83	25.68	7.19	0.77	22.85
	10	8.23	0.71	19.74	7.72	0.67	17.68	7.22	0.62	15.74	6.74	0.58	13.91
	12	7.77	0.56	13.03	7.27	0.52	11.60	6.78	0.49	10.26	6.29	0.45	9.00
	14	7.31	0.45	8.97	6.81	0.42	7.93	6.32	0.39	6.96	5.83	0.36	6.05
	16	6.85	0.37	6.40	6.36	0.34	5.62	5.86	0.32	4.89	5.37	0.29	4.20

Heating capacity

MDVF-600D302E													
EWT	ΔT	Indoor temperature (W.B.)											
		16			18			20			22		
		TH	WF	WPD	TH	WF	WPD	TH	WF	WPD	TH	WF	WPD
°C	°C	kW	m³/h	kPa	kW	m³/h	kPa	kW	m³/h	kPa	kW	m³/h	kPa
40	8	4.95	0.53	5.55	4.32	0.47	4.38	3.69	0.40	3.34	3.06	0.33	2.43
	10	4.32	0.37	3.01	3.68	0.32	2.29	3.04	0.26	1.66	2.39	0.21	1.07
	12	3.66	0.26	1.69	3.01	0.22	1.18	2.40	0.17	0.67	1.83	0.13	0.34
	14	2.99	0.18	0.78	2.42	0.15	0.44	1.83	0.11	0.27	1.23	0.08	0.18
	16	2.44	0.13	0.34	1.84	0.10	0.25	1.23	0.07	0.17	0.62	0.03	0.09
45	8	6.53	0.70	8.75	5.90	0.64	7.32	5.26	0.57	6.01	4.63	0.50	4.82
	10	5.92	0.51	5.04	5.28	0.46	4.14	4.64	0.40	3.32	4.01	0.35	2.58
	12	5.29	0.38	3.07	4.65	0.33	2.46	4.01	0.29	1.91	3.36	0.24	1.42
	14	4.63	0.29	1.89	3.98	0.25	1.46	3.33	0.21	1.06	2.71	0.17	0.65
	16	3.95	0.21	1.14	3.32	0.18	0.76	2.74	0.15	0.46	2.16	0.12	0.27
50	8	8.11	0.87	12.48	7.47	0.81	10.80	6.83	0.74	9.24	6.20	0.67	7.80
	10	7.51	0.65	7.46	6.86	0.59	6.39	6.23	0.54	5.39	5.59	0.48	4.48
	12	6.89	0.50	4.70	6.24	0.45	3.97	5.61	0.40	3.30	4.97	0.36	2.68
	14	6.26	0.39	3.08	5.61	0.35	2.56	4.97	0.31	2.08	4.33	0.27	1.64
	16	5.62	0.30	2.06	4.97	0.27	1.67	4.32	0.23	1.32	3.67	0.20	0.99
55	8	9.70	1.05	16.80	9.05	0.98	14.87	8.40	0.91	12.99	7.76	0.84	11.31
	10	9.10	0.79	10.20	8.45	0.73	8.96	7.80	0.67	7.81	7.16	0.62	6.73
	12	8.47	0.61	6.59	7.83	0.56	5.74	7.19	0.52	4.95	6.55	0.47	4.21
	14	7.87	0.49	4.47	7.22	0.45	3.86	6.58	0.41	3.28	5.94	0.37	2.76
	16	7.24	0.39	3.09	6.59	0.36	2.63	5.95	0.32	2.20	5.30	0.29	1.81
60	8	11.28	1.22	21.43	10.62	1.14	19.28	9.98	1.08	17.34	9.33	1.01	15.41
	10	10.68	0.92	13.20	10.02	0.86	11.82	9.37	0.81	10.51	8.73	0.75	9.28
	12	10.08	0.73	8.74	9.41	0.68	7.78	8.78	0.63	6.87	8.13	0.59	6.02
	14	9.46	0.58	6.01	8.81	0.54	5.31	8.17	0.50	4.65	7.51	0.46	4.04
	16	8.85	0.48	4.28	8.20	0.44	3.75	7.56	0.41	3.26	6.91	0.37	2.78

Heating capacity

MDVF-800D302E													
EWT	ΔT	Indoor temperature (W.B.)											
		16			18			20			22		
		TH	WF	WPD	TH	WF	WPD	TH	WF	WPD	TH	WF	WPD
°C	°C	kW	m³/h	kPa	kW	m³/h	kPa	kW	m³/h	kPa	kW	m³/h	kPa
40	8	6.36	0.69	5.14	5.54	0.60	4.06	4.73	0.51	3.10	3.92	0.42	2.25
	10	5.54	0.48	2.79	4.72	0.41	2.13	3.89	0.34	1.54	3.07	0.27	0.98
	12	4.69	0.34	1.56	3.86	0.28	1.07	3.09	0.22	0.61	2.35	0.17	0.31
	14	3.85	0.24	0.71	3.12	0.19	0.40	2.35	0.15	0.26	1.58	0.10	0.18
	16	3.14	0.17	0.32	2.36	0.13	0.24	1.58	0.09	0.16	0.80	0.04	0.08
45	8	8.39	0.91	8.11	7.57	0.82	6.78	6.75	0.73	5.57	5.94	0.64	4.47
	10	7.59	0.66	4.67	6.77	0.58	3.83	5.95	0.51	3.08	5.14	0.44	2.39
	12	6.79	0.49	2.84	5.96	0.43	2.28	5.14	0.37	1.77	4.31	0.31	1.32
	14	5.94	0.37	1.75	5.10	0.31	1.36	4.27	0.26	0.96	3.49	0.22	0.58
	16	5.07	0.27	1.04	4.27	0.23	0.69	3.53	0.19	0.41	2.78	0.15	0.26
50	8	10.42	1.12	11.57	9.59	1.03	10.01	8.77	0.95	8.56	7.95	0.86	7.22
	10	9.64	0.83	6.91	8.81	0.76	5.92	7.99	0.69	4.99	7.17	0.62	4.15
	12	8.84	0.64	4.35	8.01	0.58	3.68	7.19	0.52	3.05	6.37	0.46	2.48
	14	8.03	0.49	2.85	7.20	0.44	2.37	6.37	0.39	1.92	5.55	0.34	1.52
	16	7.21	0.39	1.91	6.37	0.34	1.55	5.53	0.30	1.22	4.70	0.25	0.90
55	8	12.46	1.35	15.57	11.61	1.25	13.70	10.78	1.16	12.03	9.96	1.07	10.47
	10	11.68	1.01	9.45	10.84	0.94	8.31	10.01	0.87	7.23	9.19	0.79	6.23
	12	10.89	0.78	6.10	10.05	0.72	5.32	9.22	0.66	4.58	8.40	0.60	3.90
	14	10.10	0.62	4.14	9.27	0.57	3.57	8.44	0.52	3.04	7.62	0.47	2.55
	16	9.28	0.50	2.86	8.45	0.46	2.43	7.62	0.41	2.04	6.79	0.37	1.68
60	8	14.50	1.56	19.86	13.65	1.47	17.93	12.81	1.38	16.06	11.97	1.29	14.20
	10	13.71	1.18	12.23	12.86	1.11	10.95	12.03	1.04	9.73	11.20	0.97	8.59
	12	12.94	0.93	8.10	12.09	0.87	7.20	11.26	0.81	6.36	10.43	0.75	5.57
	14	12.15	0.75	5.57	11.31	0.70	4.92	10.47	0.65	4.31	9.65	0.59	3.74
	16	11.36	0.61	3.96	10.52	0.57	3.47	9.68	0.52	3.00	8.85	0.48	2.58

Heating capacity

MDVF-1000D302E													
EWT	ΔT	Indoor temperature (W.B.)											
		16			18			20			22		
		TH	WF	WPD	TH	WF	WPD	TH	WF	WPD	TH	WF	WPD
$^{\circ}\text{C}$	$^{\circ}\text{C}$	kW	m ³ /h	kPa	kW	m ³ /h	kPa	kW	m ³ /h	kPa	kW	m ³ /h	kPa
40	8	7.59	0.82	7.58	6.63	0.71	6.00	5.67	0.61	4.59	4.71	0.51	3.34
	10	6.65	0.57	4.14	5.68	0.49	3.17	4.71	0.41	2.30	3.73	0.32	1.55
	12	5.66	0.41	2.34	4.68	0.34	1.69	3.70	0.27	1.06	2.82	0.20	0.51
	14	4.63	0.29	1.22	3.72	0.23	0.70	2.84	0.18	0.36	1.92	0.12	0.23
	16	3.77	0.20	0.50	2.86	0.15	0.31	1.93	0.10	0.21	0.99	0.05	0.11
45	8	9.99	1.08	11.93	9.02	0.97	9.99	8.06	0.87	8.21	7.10	0.77	6.60
	10	9.07	0.78	6.89	8.10	0.70	5.67	7.13	0.62	4.56	6.17	0.53	3.55
	12	8.13	0.59	4.21	7.16	0.52	3.39	6.19	0.45	2.64	5.22	0.38	1.97
	14	7.16	0.44	2.62	6.17	0.38	2.03	5.19	0.32	1.52	4.20	0.26	1.01
	16	6.16	0.33	1.63	5.15	0.28	1.17	4.22	0.23	0.72	3.34	0.18	0.39
50	8	12.39	1.34	17.01	11.41	1.23	14.73	10.44	1.13	12.61	9.48	1.02	10.65
	10	11.48	0.99	10.18	10.51	0.91	8.72	9.54	0.82	7.37	8.57	0.74	6.13
	12	10.55	0.76	6.42	9.58	0.69	5.43	8.61	0.62	4.52	7.64	0.55	3.68
	14	9.62	0.59	4.22	8.64	0.53	3.51	7.66	0.47	2.86	6.69	0.41	2.27
	16	8.67	0.47	2.84	7.68	0.41	2.31	6.70	0.36	1.83	5.71	0.31	1.40
55	8	14.80	1.60	22.84	13.80	1.49	20.27	12.83	1.39	17.81	11.85	1.28	15.51
	10	13.89	1.20	13.85	12.91	1.12	12.23	11.93	1.03	10.66	10.96	0.95	9.19
	12	12.97	0.93	8.99	11.99	0.86	7.84	11.01	0.79	6.77	10.04	0.72	5.77
	14	12.06	0.74	6.11	11.08	0.68	5.28	10.10	0.62	4.50	9.11	0.56	3.78
	16	11.12	0.60	4.23	10.13	0.55	3.61	9.15	0.49	3.03	8.18	0.44	2.50
60	8	17.21	1.86	29.27	16.20	1.75	26.27	15.21	1.64	23.50	14.24	1.53	20.90
	10	16.30	1.41	18.08	15.31	1.32	16.18	14.32	1.24	14.40	13.33	1.15	12.66
	12	15.41	1.11	11.93	14.41	1.04	10.62	13.42	0.97	9.38	12.44	0.90	8.22
	14	14.48	0.89	8.21	13.49	0.83	7.25	12.51	0.77	6.36	11.53	0.71	5.52
	16	13.56	0.73	5.86	12.57	0.68	5.14	11.59	0.63	4.46	10.61	0.57	3.83

Heating capacity

MDVF-1200D302E													
EWT	ΔT	Indoor temperature (W.B.)											
		16			18			20			22		
		TH	WF	WPD	TH	WF	WPD	TH	WF	WPD	TH	WF	WPD
°C	°C	kW	m³/h	kPa	kW	m³/h	kPa	kW	m³/h	kPa	kW	m³/h	kPa
40	8	9.86	1.07	14.56	8.63	0.93	11.55	7.40	0.80	8.86	6.17	0.67	6.45
	10	8.69	0.75	7.98	7.45	0.64	6.13	6.22	0.54	4.49	4.98	0.43	3.08
	12	7.50	0.54	4.58	6.25	0.45	3.36	4.99	0.36	2.29	3.73	0.27	1.30
	14	6.24	0.38	2.59	4.96	0.31	1.72	3.75	0.23	0.86	2.59	0.16	0.39
	16	4.98	0.27	1.26	3.82	0.21	0.62	2.61	0.14	0.35	1.35	0.07	0.18
45	8	12.91	1.39	22.66	11.67	1.26	18.99	10.43	1.13	15.63	9.21	0.99	12.58
	10	11.77	1.02	13.15	10.53	0.91	10.84	9.29	0.80	8.73	8.06	0.70	6.83
	12	10.61	0.76	8.10	9.37	0.67	6.53	8.13	0.59	5.11	6.89	0.50	3.85
	14	9.42	0.58	5.08	8.16	0.50	3.98	6.91	0.43	2.99	5.65	0.35	2.13
	16	8.20	0.44	3.23	6.93	0.37	2.43	5.65	0.30	1.71	4.40	0.24	0.97
50	8	15.96	1.72	32.21	14.72	1.59	28.05	13.47	1.46	24.03	12.23	1.32	20.20
	10	14.84	1.28	19.35	13.59	1.17	16.59	12.35	1.07	14.03	11.11	0.96	11.68
	12	13.69	0.98	12.25	12.44	0.89	10.37	11.19	0.80	8.64	9.96	0.72	7.06
	14	12.53	0.77	8.10	11.28	0.69	6.75	10.03	0.62	5.52	8.79	0.54	4.40
	16	11.35	0.61	5.46	10.09	0.54	4.46	8.85	0.48	3.57	7.59	0.41	2.75
55	8	19.01	2.06	43.29	17.78	1.92	38.26	16.52	1.78	33.64	15.27	1.64	29.22
	10	17.90	1.54	26.25	16.63	1.43	23.09	15.39	1.33	20.13	14.14	1.22	17.37
	12	16.75	1.21	17.16	15.51	1.12	14.97	14.25	1.02	12.87	13.01	0.94	10.98
	14	15.63	0.96	11.66	14.37	0.89	10.07	13.12	0.81	8.60	11.87	0.73	7.24
	16	14.47	0.78	8.13	13.21	0.71	6.94	11.95	0.65	5.85	10.69	0.58	4.82
60	8	22.09	2.38	55.13	20.82	2.25	49.90	19.55	2.10	44.42	18.30	1.97	39.60
	10	20.98	1.81	34.16	19.70	1.70	30.51	18.44	1.59	27.27	17.20	1.49	24.10
	12	19.85	1.43	22.54	18.58	1.33	20.07	17.31	1.24	17.74	16.07	1.16	15.62
	14	18.71	1.15	15.60	17.44	1.07	13.79	16.18	1.00	12.10	14.93	0.92	10.52
	16	17.58	0.95	11.16	16.31	0.88	9.79	15.04	0.81	8.52	13.79	0.74	7.32

Heating capacity

MDVF-1400D302E													
EWT	ΔT	Indoor temperature (W.B.)											
		16			18			20			22		
		TH	WF	WPD	TH	WF	WPD	TH	WF	WPD	TH	WF	WPD
$^{\circ}\text{C}$	$^{\circ}\text{C}$	kW	m ³ /h	kPa	kW	m ³ /h	kPa	kW	m ³ /h	kPa	kW	m ³ /h	kPa
40	8	10.39	1.12	17.56	9.09	0.98	13.94	7.80	0.84	10.69	6.51	0.70	7.79
	10	9.17	0.79	9.64	7.87	0.68	7.41	6.57	0.57	5.44	5.27	0.45	3.73
	12	7.94	0.57	5.55	6.62	0.48	4.07	5.30	0.38	2.79	3.96	0.29	1.65
	14	6.64	0.41	3.18	5.28	0.33	2.14	3.98	0.25	1.11	2.74	0.17	0.46
	16	5.30	0.29	1.61	4.05	0.22	0.79	2.77	0.15	0.41	1.43	0.08	0.22
45	8	13.60	1.47	27.46	12.28	1.32	22.87	10.99	1.18	18.82	9.71	1.05	15.25
	10	12.40	1.07	15.85	11.09	0.96	13.06	9.79	0.84	10.53	8.50	0.73	8.24
	12	11.19	0.81	9.77	9.88	0.71	7.88	8.57	0.62	6.18	7.27	0.52	4.66
	14	9.94	0.61	6.14	8.62	0.53	4.81	7.31	0.45	3.63	5.99	0.37	2.59
	16	8.68	0.47	3.91	7.34	0.40	2.95	6.00	0.32	2.10	4.67	0.25	1.24
50	8	16.81	1.82	38.99	15.48	1.67	33.68	14.16	1.53	28.73	12.87	1.39	24.43
	10	15.62	1.35	23.31	14.30	1.24	19.97	12.99	1.12	16.89	11.70	1.01	14.06
	12	14.41	1.04	14.77	13.10	0.94	12.50	11.79	0.85	10.42	10.49	0.75	8.51
	14	13.20	0.81	9.77	11.89	0.73	8.14	10.57	0.65	6.66	9.27	0.57	5.31
	16	11.97	0.65	6.60	10.65	0.57	5.39	9.32	0.50	4.30	8.02	0.43	3.33
55	8	20.01	2.16	52.07	18.68	2.02	46.11	17.36	1.88	40.54	16.05	1.73	35.25
	10	18.83	1.63	31.72	17.51	1.51	27.91	16.18	1.40	24.22	14.87	1.28	20.89
	12	17.65	1.27	20.66	16.32	1.18	18.02	15.01	1.08	15.56	13.69	0.98	13.21
	14	16.45	1.01	13.99	15.13	0.93	12.13	13.81	0.85	10.36	12.50	0.77	8.71
	16	15.24	0.82	9.80	13.91	0.75	8.37	12.59	0.68	7.05	11.28	0.61	5.83
60	8	23.23	2.51	66.67	21.87	2.35	59.65	20.54	2.21	53.37	19.23	2.08	47.74
	10	22.05	1.90	40.98	20.72	1.79	36.78	19.38	1.67	32.64	18.06	1.56	28.89
	12	20.87	1.50	27.12	19.53	1.40	24.14	18.21	1.31	21.34	16.88	1.21	18.71
	14	19.69	1.21	18.77	18.35	1.13	16.60	17.02	1.05	14.56	15.71	0.97	12.65
	16	18.50	1.00	13.44	17.16	0.93	11.79	15.83	0.85	10.25	14.51	0.78	8.81

3-row Duct 12Pa Cooling capacity

EWT: Enter Water Temp. (°C) **Δt:** Temperature Difference (°C) **DB:** Dry Bulb Temp. (°C) **WB:** Wet Bulb Temp. (°C)

TC: Total Cooling Capacity (kW) **SC:** Sensible Cooling Capacity (kW) **WF:** Water Flow (m³/h) **WPD:** Water Pressure Drop (kPa)

MDVF-200D3E																						
EWT	ΔT	Indoor temp (W.B.)	Indoor temperature (D.B.)																			
			21				23				25				27				29			
			TC	SC	WF	WPD	TC	SC	WF	WPD	TC	SC	WF	WPD	TC	SC	WF	WPD	TC	SC	WF	WPD
°C	°C	°C	kW	kW	m³/h	kPa	kW	kW	m³/h	kPa	kW	kW	m³/h	kPa	kW	kW	m³/h	kPa	kW	kW	m³/h	kPa
5	3	15	1.78	1.42	0.51	15.65	1.76	1.63	0.51	15.37	1.84	1.84	0.53	16.41	2.06	2.06	0.59	20.07	2.27	2.27	0.65	23.70
		17	2.42	1.42	0.69	26.46	2.40	1.64	0.69	26.26	2.39	1.85	0.69	25.95	2.37	2.06	0.68	25.60	2.35	2.27	0.68	25.21
		19	-	-	-	-	3.09	1.64	0.88	40.21	3.07	1.85	0.88	39.65	3.05	2.07	0.87	39.14	3.03	2.27	0.87	38.67
		20	-	-	-	-	3.46	1.64	1.00	49.37	3.43	1.86	0.99	48.82	3.41	2.07	0.98	48.27	3.39	2.28	0.98	47.72
	4	15	1.49	1.29	0.32	7.03	1.50	1.49	0.32	7.09	1.72	1.72	0.37	8.96	1.93	1.93	0.41	10.81	2.14	2.14	0.46	12.89
		17	2.14	1.29	0.46	12.87	2.12	1.51	0.45	12.71	2.11	1.72	0.45	12.54	2.09	1.93	0.45	12.34	2.14	2.14	0.46	12.92
		19	-	-	-	-	2.82	1.52	0.61	20.84	2.80	1.73	0.60	20.59	2.78	1.94	0.60	20.35	2.76	2.15	0.59	20.12
		20	-	-	-	-	3.17	1.52	0.68	25.39	3.15	1.73	0.68	25.10	3.13	1.94	0.67	24.81	3.11	2.15	0.67	24.52
	5	15	1.19	1.16	0.21	2.68	1.37	1.37	0.24	3.85	1.59	1.59	0.27	5.29	1.80	1.80	0.31	6.56	2.02	2.02	0.35	7.92
		17	1.84	1.16	0.32	6.79	1.83	1.38	0.31	6.70	1.81	1.59	0.31	6.58	1.80	1.80	0.31	6.57	2.02	2.02	0.35	7.95
		19	-	-	-	-	2.53	1.39	0.43	11.63	2.51	1.60	0.43	11.49	2.49	1.82	0.43	11.35	2.47	2.03	0.42	11.21
		20	-	-	-	-	2.90	1.40	0.50	14.87	2.87	1.61	0.49	14.49	2.85	1.82	0.49	14.32	2.83	2.03	0.49	14.16
6	15	1.05	1.05	0.15	1.23	1.26	1.26	0.18	1.90	1.46	1.46	0.21	2.87	1.68	1.68	0.24	4.04	1.89	1.89	0.27	5.18	
	17	1.53	1.03	0.22	3.22	1.51	1.25	0.22	3.14	1.50	1.47	0.21	3.07	1.68	1.68	0.24	4.06	1.89	1.89	0.27	5.20	
	19	-	-	-	-	2.22	1.26	0.32	6.86	2.21	1.48	0.32	6.77	2.19	1.69	0.31	6.68	2.17	1.90	0.31	6.57	
	20	-	-	-	-	2.60	1.27	0.37	8.91	2.58	1.48	0.37	8.80	2.56	1.70	0.37	8.70	2.54	1.91	0.36	8.59	
7	3	15	1.28	1.19	0.37	8.67	1.41	1.41	0.40	10.29	1.63	1.63	0.47	13.12	1.84	1.84	0.53	16.43	2.05	2.05	0.59	19.79
		17	1.93	1.20	0.56	17.84	1.92	1.42	0.55	17.60	1.90	1.63	0.55	17.31	1.88	1.85	0.54	17.09	2.06	2.06	0.59	19.85
		19	-	-	-	-	2.60	1.42	0.75	29.88	2.59	1.64	0.75	29.53	2.57	1.85	0.74	29.18	2.55	2.06	0.74	28.82
		20	-	-	-	-	2.97	1.42	0.86	37.48	2.95	1.64	0.85	37.05	2.93	1.85	0.85	36.62	2.91	2.06	0.84	36.19
	4	15	1.06	1.06	0.23	3.63	1.28	1.28	0.28	5.37	1.50	1.50	0.32	7.01	1.72	1.72	0.37	8.79	1.93	1.93	0.42	10.72
		17	1.63	1.07	0.35	8.05	1.61	1.29	0.35	7.91	1.60	1.51	0.34	7.78	1.72	1.72	0.37	8.82	1.93	1.93	0.42	10.75
		19	-	-	-	-	2.31	1.30	0.50	14.68	2.30	1.51	0.50	14.50	2.28	1.73	0.49	14.32	2.26	1.94	0.49	14.10
		20	-	-	-	-	2.67	1.30	0.57	18.65	2.65	1.52	0.57	18.42	2.63	1.73	0.57	18.20	2.62	1.94	0.56	17.98
	5	15	0.95	0.95	0.16	1.54	1.16	1.16	0.20	2.58	1.37	1.37	0.24	3.95	1.59	1.59	0.27	5.23	1.80	1.80	0.31	6.48
		17	1.30	0.94	0.22	3.49	1.29	1.16	0.22	3.39	1.37	1.37	0.24	3.96	1.59	1.59	0.27	5.25	1.81	1.81	0.31	6.50
		19	-	-	-	-	2.00	1.17	0.34	7.73	1.99	1.39	0.34	7.63	1.97	1.61	0.35	17.68	1.95	1.81	0.34	7.38
		20	-	-	-	-	2.37	1.18	0.41	10.31	2.35	1.39	0.40	10.18	2.34	1.61	0.40	10.05	2.32	1.82	0.40	9.91
6	15	0.85	0.85	0.12	0.87	1.06	1.06	0.15	1.26	1.26	1.26	0.18	2.01	1.47	1.47	0.21	3.03	1.68	1.68	0.24	4.15	
	17	1.04	0.84	0.15	1.22	1.06	1.06	0.15	1.29	1.26	1.26	0.18	2.02	1.47	1.47	0.21	3.04	1.68	1.68	0.24	4.17	
	19	-	-	-	-	1.67	1.04	0.24	4.11	1.65	1.26	0.24	4.02	1.63	1.47	0.24	3.92	1.68	1.66	0.24	4.15	
	20	-	-	-	-	2.05	1.05	0.29	5.86	2.03	1.26	0.29	5.78	2.01	1.48	0.29	5.69	1.99	1.69	0.29	5.59	
9	3	15	0.97	0.97	0.28	5.38	1.19	1.19	0.34	7.62	1.41	1.41	0.40	10.12	1.62	1.62	0.47	12.89	1.84	1.84	0.53	16.01
		17	1.40	0.98	0.40	9.97	1.38	1.20	0.40	9.77	1.41	1.39	0.40	10.06	1.63	1.63	0.47	12.93	1.84	1.84	0.53	16.07
		19	-	-	-	-	2.08	1.20	0.60	19.65	2.06	1.42	0.59	19.39	2.04	1.63	0.59	19.09	2.02	1.84	0.58	18.77
		20	-	-	-	-	2.44	1.20	0.70	26.00	2.42	1.42	0.70	25.68	2.40	1.63	0.69	25.36	2.39	1.85	0.69	25.03
	4	15	0.85	0.85	0.18	2.12	1.07	1.07	0.23	3.78	1.28	1.28	0.28	5.26	1.50	1.50	0.32	6.85	1.71	1.71	0.37	8.59
		17	1.07	0.85	0.23	3.78	1.07	1.07	0.23	3.81	1.29	1.29	0.28	5.28	1.50	1.50	0.32	6.88	1.72	1.72	0.37	8.62
		19	-	-	-	-	1.76	1.08	0.38	9.03	1.75	1.29	0.38	8.88	1.73	1.51	0.37	8.72	1.73	1.72	0.37	8.74
		20	-	-	-	-	2.13	1.08	0.46	12.47	2.12	1.30	0.46	12.31	2.10	1.51	0.45	12.14	2.08	1.72	0.45	11.94
	5	15	0.74	0.74	0.13	0.90	0.95	0.95	0.16	1.57	1.16	1.16	0.20	2.68	1.37	1.37	0.24	3.99	1.59	1.59	0.27	5.15
		17	0.80	0.74	0.14	1.01	0.95	0.95	0.16	1.58	1.16	1.16	0.20	2.69	1.38	1.38	0.24	4.00	1.59	1.59	0.27	5.17
		19	-	-	-	-	1.42	0.95	0.24	4.26	1.40	1.16	0.24	4.16	1.40	1.38	0.24	4.14	1.60	1.60	0.27	5.19
		20	-	-	-	-	1.80	0.95	0.31	6.38	1.79	1.17	0.31	6.28	1.77	1.39	0.30	6.17	1.75	1.60	0.30	6.07
6	15	0.63	0.63	0.09	0.62	0.85	0.85	0.12	0.83	1.05	1.05	0.15	1.29	1.26	1.26	0.18	2.07	1.47	1.47	0.21	3.09	
	17	0.63	0.63	0.09	0.62	0.85	0.85	0.12	0.83	1.05	1.05	0.15	1.29	1.26	1.26	0.18	2.08	1.47	1.47	0.21	3.10	
	19	-	-	-	-	1.11	0.83	0.16	1.48	1.11	1.05	0.16	1.48	1.26	1.26	0.18	2.10	1.47	1.47	0.21	3.12	
	20	-	-	-	-	1.45	0.82	0.21	3.00	1.43	1.04	0.20	2.91	1.41	1.26	0.20	2.83	1.46	1.45	0.21	3.09	

Continued:

MDVF-200D3E																							
EWT	ΔT	Indoor temp (W.B.)	Indoor temperature (D.B.)																				
			21				23				25				27				29				
			TC	SC	WF	WPD	TC	SC	WF	WPD	TC	SC	WF	WPD	TC	SC	WF	WPD	TC	SC	WF	WPD	
°C	°C	°C	kW	kW	m³/h	kPa	kW	kW	m³/h	kPa	kW	kW	m³/h	kPa	kW	kW	m³/h	kPa	kW	kW	m³/h	kPa	
11	3	15	0.75	0.75	0.21	3.20	0.97	0.97	0.28	5.23	1.19	1.19	0.34	7.39	1.41	1.41	0.40	9.81	1.62	1.62	0.46	12.49	
		17	0.81	0.75	0.23	3.84	0.97	0.97	0.28	5.25	1.19	1.19	0.34	7.41	1.41	1.41	0.40	9.85	1.62	1.62	0.46	12.54	
		19	-	-	-	-	1.51	0.98	0.43	11.08	1.49	1.20	0.43	10.86	1.48	1.41	0.42	10.72	1.63	1.63	0.46	12.58	
		20	-	-	-	-	1.88	0.98	0.54	16.10	1.86	1.20	0.53	15.87	1.84	1.42	0.53	15.60	1.83	1.63	0.52	15.36	
	4	15	0.64	0.64	0.14	1.02	0.85	0.85	0.18	2.14	1.07	1.07	0.23	3.71	1.28	1.28	0.27	5.14	1.50	1.50	0.32	6.68	
		17	0.64	0.63	0.14	1.01	0.85	0.85	0.18	2.15	1.07	1.07	0.23	3.73	1.29	1.29	0.28	5.15	1.50	1.50	0.32	6.70	
		19	-	-	-	-	1.16	0.85	0.25	4.34	1.15	1.07	0.25	4.28	1.29	1.29	0.28	5.17	1.51	1.51	0.32	6.73	
		20	-	-	-	-	1.54	0.86	0.33	7.02	1.53	1.08	0.33	6.89	1.51	1.29	0.32	6.75	1.52	1.51	0.32	6.82	
	5	15	0.53	0.53	0.09	0.60	0.75	0.75	0.13	0.89	0.95	0.95	0.16	1.64	1.16	1.16	0.20	2.78	1.38	1.38	0.24	3.97	
		17	0.53	0.53	0.09	0.60	0.75	0.75	0.13	0.89	0.95	0.95	0.16	1.65	1.16	1.16	0.20	2.79	1.38	1.38	0.24	3.99	
		19	-	-	-	-	0.85	0.74	0.15	1.22	0.95	0.94	0.16	1.65	1.17	1.17	0.20	2.81	1.38	1.38	0.24	4.00	
		20	-	-	-	-	1.18	0.73	0.20	2.89	1.16	0.95	0.20	2.80	1.17	1.17	0.20	2.86	1.38	1.38	0.24	4.01	
	6	15	0.42	0.42	0.06	0.39	0.64	0.64	0.09	0.59	0.85	0.85	0.12	0.81	1.05	1.05	0.15	1.33	1.26	1.26	0.18	2.16	
		17	0.43	0.43	0.06	0.39	0.64	0.64	0.09	0.59	0.85	0.85	0.12	0.81	1.05	1.05	0.15	1.34	1.26	1.26	0.18	2.17	
		19	-	-	-	-	0.64	0.64	0.09	0.59	0.85	0.85	0.12	0.81	1.06	1.06	0.15	1.35	1.26	1.26	0.18	2.18	
		20	-	-	-	-	0.88	0.63	0.13	0.87	0.89	0.85	0.13	0.89	1.06	1.05	0.15	1.35	1.26	1.26	0.18	2.19	
	13	3	15	0.53	0.53	0.15	1.39	0.75	0.75	0.22	3.33	0.97	0.97	0.28	5.22	1.19	1.19	0.34	7.36	1.41	1.41	0.40	9.77
			17	0.54	0.54	0.15	1.40	0.75	0.75	0.22	3.34	0.98	0.98	0.28	5.24	1.19	1.19	0.34	7.39	1.41	1.41	0.40	9.80
			19	-	-	-	-	0.89	0.76	0.26	4.52	0.97	0.95	0.28	5.20	1.20	1.20	0.34	7.41	1.41	1.41	0.41	9.84
			20	-	-	-	-	1.27	0.76	0.36	8.21	1.25	0.98	0.36	8.03	1.25	1.20	0.36	7.98	1.41	1.41	0.41	9.86
		4	15	0.43	0.43	0.09	0.58	0.64	0.64	0.14	1.05	0.85	0.85	0.18	2.26	1.07	1.07	0.23	3.73	1.28	1.28	0.28	5.11
			17	0.43	0.43	0.09	0.58	0.64	0.64	0.14	1.06	0.85	0.85	0.18	2.27	1.07	1.07	0.23	3.74	1.28	1.28	0.28	5.06
			19	-	-	-	-	0.64	0.62	0.14	1.04	0.85	0.85	0.18	2.28	1.07	1.07	0.23	3.76	1.29	1.29	0.28	5.08
			20	-	-	-	-	0.89	0.63	0.19	2.55	0.89	0.85	0.19	2.55	1.07	1.07	0.23	3.76	1.29	1.29	0.28	5.09
5		15	0.32	0.32	0.05	0.34	0.53	0.53	0.09	0.57	0.74	0.74	0.13	0.88	0.95	0.95	0.16	1.67	1.16	1.16	0.20	2.80	
		17	0.32	0.32	0.05	0.34	0.53	0.53	0.09	0.57	0.74	0.74	0.13	0.88	0.95	0.95	0.16	1.68	1.16	1.16	0.20	2.81	
		19	-	-	-	-	0.53	0.53	0.09	0.57	0.75	0.75	0.13	0.89	0.95	0.95	0.16	1.69	1.16	1.16	0.20	2.83	
		20	-	-	-	-	0.60	0.53	0.10	0.63	0.75	0.74	0.13	0.89	0.95	0.95	0.16	1.69	1.16	1.16	0.20	2.83	
6		15	0.21	0.21	0.03	0.18	0.42	0.42	0.06	0.37	0.64	0.64	0.09	0.56	0.85	0.85	0.12	0.79	1.05	1.05	0.15	1.36	
		17	0.21	0.21	0.03	0.18	0.43	0.43	0.06	0.37	0.64	0.64	0.09	0.56	0.85	0.85	0.12	0.80	1.05	1.05	0.15	1.37	
		19	-	-	-	-	0.43	0.43	0.06	0.37	0.64	0.64	0.09	0.56	0.85	0.85	0.12	0.80	1.05	1.05	0.15	1.38	
		20	-	-	-	-	0.43	0.42	0.06	0.37	0.64	0.64	0.09	0.56	0.85	0.85	0.12	0.80	1.05	1.05	0.15	1.38	
15		3	15	0.32	0.32	0.09	0.56	0.53	0.53	0.15	1.40	0.75	0.75	0.21	3.26	0.97	0.97	0.28	5.06	1.19	1.19	0.34	7.13
			17	0.32	0.32	0.09	0.56	0.53	0.53	0.15	1.41	0.75	0.75	0.21	3.27	0.97	0.97	0.28	5.08	1.19	1.19	0.34	7.15
			19	-	-	-	-	0.53	0.53	0.15	1.42	0.75	0.75	0.21	3.29	0.97	0.97	0.28	5.10	1.19	1.19	0.34	7.18
			20	-	-	-	-	0.60	0.53	0.17	1.90	0.75	0.75	0.21	3.29	0.98	0.98	0.28	5.11	1.19	1.19	0.34	7.19
		4	15	0.21	0.21	0.05	0.27	0.43	0.43	0.09	0.55	0.64	0.64	0.14	1.07	0.85	0.85	0.18	2.29	1.07	1.07	0.23	3.64
			17	0.21	0.21	0.05	0.27	0.43	0.43	0.09	0.55	0.64	0.64	0.14	1.07	0.85	0.85	0.18	2.30	1.07	1.07	0.23	3.65
			19	-	-	-	-	0.43	0.43	0.09	0.55	0.64	0.64	0.14	1.08	0.85	0.85	0.18	2.31	1.07	1.07	0.23	3.66
			20	-	-	-	-	0.43	0.42	0.09	0.55	0.64	0.64	0.14	1.08	0.85	0.85	0.18	2.32	1.07	1.07	0.23	3.67
	5	15	0.11	0.11	0.02	0.11	0.32	0.32	0.06	0.33	0.53	0.53	0.09	0.54	0.74	0.74	0.13	0.91	0.95	0.95	0.16	1.76	
		17	0.11	0.11	0.02	0.11	0.32	0.32	0.06	0.33	0.54	0.54	0.09	0.54	0.74	0.74	0.13	0.91	0.95	0.95	0.16	1.77	
		19	-	-	-	-	0.32	0.32	0.06	0.33	0.54	0.54	0.09	0.55	0.75	0.75	0.13	0.92	0.95	0.95	0.16	1.78	
		20	-	-	-	-	0.32	0.32	0.06	0.33	0.54	0.54	0.09	0.55	0.75	0.75	0.13	0.92	0.95	0.95	0.16	1.78	
	6	15	-	-	-	-	0.21	0.21	0.03	0.18	0.43	0.43	0.06	0.35	0.64	0.64	0.09	0.53	0.85	0.85	0.12	0.81	
		17	-	-	-	-	0.22	0.22	0.03	0.18	0.43	0.43	0.06	0.36	0.64	0.64	0.09	0.53	0.85	0.85	0.12	0.81	
		19	-	-	-	-	0.22	0.22	0.03	0.18	0.43	0.43	0.06	0.36	0.64	0.64	0.09	0.53	0.85	0.85	0.12	0.81	
		20	-	-	-	-	0.22	0.22	0.03	0.18	0.43	0.43	0.06	0.36	0.64	0.64	0.09	0.53	0.85	0.85	0.12	0.82	

Cooling capacity

MDVF-300D3E																						
EWT	ΔT	Indoor temp (W.B.)	Indoor temperature (D.B.)																			
			21				23				25				27				29			
			TC	SC	WF	WPD	TC	SC	WF	WPD	TC	SC	WF	WPD	TC	SC	WF	WPD	TC	SC	WF	WPD
°C	°C	°C	kW	kW	m³/h	kPa	kW	kW	m³/h	kPa	kW	kW	m³/h	kPa	kW	kW	m³/h	kPa	kW	kW	m³/h	kPa
5	3	15	2.58	2.03	0.74	34.97	2.56	2.34	0.73	34.41	2.64	2.63	0.75	36.27	2.94	2.94	0.84	43.72	3.23	3.23	0.93	51.63
		17	3.49	2.04	1.00	58.97	3.46	2.34	0.99	58.29	3.44	2.64	0.99	57.60	3.41	2.94	0.98	56.80	3.39	3.24	0.97	56.03
		19	-	-	-	-	4.44	2.35	1.28	91.40	4.41	2.66	1.28	90.33	4.38	2.95	1.26	88.98	4.35	3.25	1.25	86.89
		20	-	-	-	-	4.95	2.35	1.42	109.64	4.92	2.66	1.42	109.65	4.89	2.96	1.42	108.52	4.86	3.26	1.41	107.34
	4	15	2.21	1.86	0.47	16.19	2.23	2.18	0.48	16.55	2.48	2.48	0.53	19.88	2.77	2.77	0.59	23.92	3.07	3.07	0.66	28.50
		17	3.12	1.87	0.67	29.34	3.10	2.18	0.66	28.98	3.07	2.48	0.66	28.57	3.05	2.78	0.65	28.16	3.09	3.08	0.66	28.83
		19	-	-	-	-	4.07	2.18	0.87	46.54	4.04	2.49	0.87	46.01	4.02	2.79	0.86	45.47	3.99	3.08	0.86	44.95
		20	-	-	-	-	4.59	2.19	0.99	57.96	4.56	2.49	0.99	57.30	4.53	2.80	0.98	56.66	4.50	3.09	0.97	55.67
	5	15	1.83	1.69	0.31	7.96	2.00	2.00	0.34	9.32	2.31	2.31	0.40	11.87	2.61	2.61	0.45	14.64	2.91	2.91	0.50	17.78
		17	2.75	1.71	0.47	16.15	2.73	2.01	0.47	15.92	2.71	2.32	0.47	15.67	2.71	2.62	0.47	15.70	2.92	2.92	0.50	17.83
		19	-	-	-	-	3.70	2.02	0.63	26.61	3.67	2.32	0.63	26.28	3.65	2.62	0.63	25.97	3.62	2.92	0.62	25.63
		20	-	-	-	-	4.22	2.02	0.73	33.68	4.19	2.33	0.72	33.29	4.16	2.63	0.72	32.89	4.13	2.93	0.71	32.52
6	15	1.53	1.53	0.22	3.84	1.83	1.83	0.26	5.82	2.14	2.14	0.31	7.65	2.45	2.45	0.35	9.59	2.75	2.75	0.39	11.72	
	17	2.35	1.53	0.34	8.93	2.32	1.84	0.33	8.77	2.31	2.15	0.33	8.71	2.45	2.45	0.35	9.63	2.75	2.75	0.40	11.76	
	19	-	-	-	-	3.32	1.86	0.48	16.15	3.29	2.16	0.47	15.95	3.27	2.46	0.47	15.74	3.24	2.76	0.46	15.50	
	20	-	-	-	-	3.83	1.86	0.55	20.52	3.80	2.16	0.54	20.27	3.77	2.46	0.54	20.03	3.75	2.76	0.54	19.79	
7	3	15	1.89	1.72	0.55	20.49	2.03	2.02	0.58	22.76	2.34	2.34	0.67	29.44	2.63	2.63	0.76	36.29	2.93	2.93	0.84	43.08
		17	2.80	1.73	0.81	40.37	2.78	2.04	0.80	39.86	2.75	2.34	0.80	39.21	2.74	2.64	0.79	38.86	2.93	2.93	0.84	43.23
		19	-	-	-	-	3.75	2.04	1.08	66.83	3.72	2.34	1.07	66.01	3.69	2.64	1.06	64.92	3.66	2.94	1.06	63.89
		20	-	-	-	-	4.27	2.05	1.24	84.49	4.24	2.35	1.23	83.52	4.20	2.65	1.21	81.20	4.18	2.95	1.21	81.56
	4	15	1.57	1.56	0.34	8.94	1.87	1.87	0.40	12.10	2.17	2.17	0.47	15.68	2.47	2.47	0.53	19.38	2.77	2.77	0.60	23.59
		17	2.41	1.56	0.52	18.53	2.38	1.87	0.51	18.21	2.36	2.17	0.51	17.99	2.48	2.47	0.53	19.47	2.77	2.77	0.60	23.66
		19	-	-	-	-	3.37	1.88	0.73	33.43	3.34	2.18	0.72	33.03	3.32	2.48	0.72	32.60	3.29	2.78	0.71	32.11
		20	-	-	-	-	3.88	1.88	0.84	42.79	3.85	2.19	0.83	42.28	3.83	2.49	0.83	41.81	3.80	2.79	0.82	41.29
	5	15	1.38	1.38	0.24	4.76	1.70	1.70	0.29	6.94	2.00	2.00	0.34	9.21	2.31	2.31	0.40	11.71	2.61	2.61	0.45	14.44
		17	2.00	1.39	0.34	9.14	1.98	1.70	0.34	9.00	2.04	2.01	0.35	9.49	2.31	2.31	0.40	11.75	2.61	2.61	0.45	14.49
		19	-	-	-	-	2.96	1.71	0.51	17.95	2.94	2.01	0.51	17.70	2.93	2.33	0.53	41.01	2.89	2.62	0.50	17.31
		20	-	-	-	-	3.48	1.71	0.60	23.69	3.45	2.02	0.59	23.40	3.43	2.32	0.59	23.11	3.40	2.62	0.59	22.78
6	15	1.23	1.23	0.18	2.24	1.53	1.53	0.22	3.98	1.83	1.83	0.26	5.78	2.14	2.14	0.31	7.53	2.45	2.45	0.35	9.42	
	17	1.55	1.22	0.22	4.16	1.59	1.53	0.23	4.37	1.84	1.84	0.26	5.80	2.15	2.15	0.31	7.55	2.45	2.45	0.35	9.45	
	19	-	-	-	-	2.55	1.54	0.36	10.08	2.52	1.85	0.36	9.90	2.50	2.15	0.36	9.76	2.54	2.46	0.36	10.04	
	20	-	-	-	-	3.07	1.55	0.44	13.96	3.05	1.86	0.44	13.83	3.03	2.16	0.44	13.63	3.00	2.46	0.43	13.42	
9	3	15	1.41	1.41	0.40	12.03	1.72	1.72	0.50	17.01	2.02	2.02	0.58	22.39	2.33	2.33	0.67	28.90	2.62	2.62	0.75	35.11
		17	2.05	1.41	0.59	22.90	2.03	1.72	0.58	22.47	2.05	2.03	0.59	22.98	2.33	2.33	0.67	29.00	2.63	2.63	0.76	35.23
		19	-	-	-	-	3.01	1.73	0.87	45.29	2.99	2.04	0.87	44.71	2.96	2.34	0.86	44.01	2.94	2.64	0.85	43.35
		20	-	-	-	-	3.52	1.73	1.01	58.66	3.49	2.04	1.01	57.94	3.47	2.34	1.00	57.23	3.44	2.64	0.99	56.44
	4	15	1.24	1.24	0.27	5.89	1.55	1.55	0.33	8.64	1.86	1.86	0.40	11.76	2.16	2.16	0.47	15.25	2.47	2.47	0.53	19.15
		17	1.63	1.24	0.35	9.34	1.64	1.56	0.35	9.46	1.86	1.86	0.40	11.80	2.17	2.17	0.47	15.30	2.47	2.47	0.53	19.22
		19	-	-	-	-	2.60	1.56	0.56	20.99	2.58	1.87	0.56	20.65	2.55	2.17	0.55	20.32	2.56	2.48	0.55	20.48
		20	-	-	-	-	3.11	1.56	0.67	28.46	3.09	1.87	0.66	28.09	3.07	2.18	0.66	27.94	3.04	2.48	0.66	27.65
	5	15	1.07	1.07	0.18	2.61	1.38	1.38	0.24	4.80	1.70	1.70	0.29	6.83	2.00	2.00	0.34	9.06	2.30	2.30	0.40	11.51
		17	1.19	1.07	0.20	3.40	1.38	1.38	0.24	4.81	1.70	1.70	0.29	6.85	2.01	2.01	0.35	9.09	2.31	2.31	0.40	11.55
		19	-	-	-	-	2.17	1.40	0.37	10.34	2.14	1.70	0.37	10.16	2.15	2.01	0.37	10.21	2.32	2.32	0.40	11.62
		20	-	-	-	-	2.69	1.40	0.46	15.09	2.67	1.71	0.46	14.86	2.64	2.02	0.46	14.60	2.63	2.32	0.45	14.45
6	15	0.93	0.93	0.13	1.15	1.22	1.22	0.18	2.30	1.53	1.53	0.22	4.04	1.84	1.84	0.26	5.72	2.14	2.14	0.31	7.42	
	17	0.95	0.94	0.14	1.20	1.23	1.23	0.18	2.31	1.53	1.53	0.22	4.06	1.84	1.84	0.26	5.73	2.15	2.15	0.31	7.44	
	19	-	-	-	-	1.70	1.22	0.24	4.97	1.70	1.53	0.24	4.98	1.86	1.85	0.27	5.82	2.15	2.15	0.31	7.47	
	20	-	-	-	-	2.24	1.23	0.32	7.98	2.21	1.54	0.32	7.82	2.20	1.85	0.31	7.72	2.25	2.16	0.32	8.03	

Continued:

MDVF-300D3E																						
EWT	ΔT	Indoor temp (W.B.)	Indoor temperature (D.B.)																			
			21				23				25				27				29			
			TC	SC	WF	WPD	TC	SC	WF	WPD	TC	SC	WF	WPD	TC	SC	WF	WPD	TC	SC	WF	WPD
°C	°C	°C	kW	kW	m³/h	kPa	kW	kW	m³/h	kPa	kW	kW	m³/h	kPa	kW	kW	m³/h	kPa	kW	kW	m³/h	kPa
11	3	15	1.09	1.09	0.31	7.61	1.41	1.41	0.40	11.67	1.71	1.71	0.49	16.39	2.02	2.02	0.58	21.73	2.32	2.32	0.66	27.78
		17	1.25	1.10	0.36	9.51	1.41	1.40	0.40	11.69	1.72	1.72	0.49	16.44	2.02	2.02	0.58	21.80	2.32	2.32	0.67	27.89
		19	-	-	-	-	2.21	1.41	0.63	25.45	2.19	1.72	0.62	24.95	2.18	2.03	0.62	24.76	2.33	2.32	0.67	27.98
		20	-	-	-	-	2.73	1.42	0.78	36.96	2.71	1.73	0.78	36.43	2.68	2.03	0.77	35.82	2.66	2.33	0.76	35.27
	4	15	0.92	0.92	0.20	3.20	1.24	1.24	0.27	5.76	1.55	1.55	0.33	8.43	1.86	1.86	0.40	11.46	2.16	2.16	0.46	14.83
		17	0.93	0.92	0.20	3.22	1.24	1.24	0.27	5.78	1.56	1.56	0.33	8.45	1.86	1.86	0.40	11.50	2.16	2.16	0.46	14.88
		19	-	-	-	-	1.76	1.25	0.38	10.47	1.76	1.56	0.38	10.39	1.88	1.87	0.40	11.66	2.17	2.17	0.46	14.93
		20	-	-	-	-	2.29	1.25	0.49	16.39	2.26	1.56	0.49	16.08	2.24	1.87	0.48	15.81	2.26	2.17	0.49	16.08
	5	15	0.78	0.78	0.13	1.17	1.08	1.08	0.19	2.73	1.39	1.39	0.24	4.78	1.70	1.70	0.29	6.74	2.00	2.00	0.34	8.92
		17	0.78	0.78	0.13	1.17	1.08	1.08	0.19	2.74	1.39	1.39	0.24	4.80	1.70	1.70	0.29	6.76	2.01	2.01	0.35	8.95
		19	-	-	-	-	1.29	1.08	0.22	4.21	1.41	1.40	0.24	4.94	1.70	1.70	0.29	6.78	2.01	2.01	0.35	8.98
		20	-	-	-	-	1.83	1.09	0.31	7.62	1.81	1.40	0.31	7.48	1.83	1.71	0.32	7.65	2.02	2.02	0.35	9.03
6	15	0.63	0.63	0.09	0.69	0.93	0.93	0.13	1.16	1.22	1.22	0.18	2.40	1.53	1.53	0.22	4.09	1.84	1.84	0.26	5.59	
	17	0.63	0.63	0.09	0.69	0.93	0.93	0.13	1.17	1.23	1.23	0.18	2.41	1.53	1.53	0.22	4.10	1.84	1.84	0.26	5.61	
	19	-	-	-	-	0.98	0.94	0.14	1.32	1.23	1.23	0.18	2.42	1.54	1.54	0.22	4.12	1.84	1.84	0.26	5.63	
	20	-	-	-	-	1.32	0.91	0.19	2.91	1.34	1.23	0.19	3.04	1.54	1.54	0.22	4.15	1.85	1.85	0.26	5.64	
13	3	15	0.78	0.78	0.22	4.25	1.10	1.10	0.31	7.60	1.41	1.41	0.40	11.63	1.71	1.71	0.49	16.33	2.01	2.01	0.58	21.62
		17	0.78	0.78	0.22	4.26	1.10	1.10	0.32	7.62	1.41	1.41	0.40	11.67	1.72	1.72	0.49	16.38	2.02	2.02	0.58	21.69
		19	-	-	-	-	1.35	1.10	0.39	10.87	1.43	1.42	0.41	11.95	1.72	1.72	0.49	16.44	2.02	2.02	0.58	21.77
		20	-	-	-	-	1.87	1.10	0.54	19.07	1.85	1.41	0.53	18.67	1.85	1.72	0.53	18.68	2.02	2.02	0.58	21.78
	4	15	0.63	0.63	0.13	1.18	0.93	0.93	0.20	3.34	1.24	1.24	0.27	5.66	1.55	1.55	0.33	8.27	1.85	1.85	0.40	11.25
		17	0.63	0.63	0.13	1.19	0.93	0.93	0.20	3.36	1.24	1.24	0.27	5.68	1.55	1.55	0.33	8.30	1.86	1.86	0.40	11.28
		19	-	-	-	-	0.95	0.94	0.20	3.50	1.24	1.24	0.27	5.70	1.55	1.55	0.33	8.33	1.86	1.86	0.40	11.32
		20	-	-	-	-	1.38	0.93	0.30	6.78	1.39	1.25	0.30	6.84	1.56	1.56	0.33	8.40	1.86	1.86	0.40	11.34
	5	15	0.47	0.47	0.08	0.60	0.78	0.78	0.13	1.17	1.07	1.07	0.18	2.77	1.39	1.39	0.24	4.67	1.69	1.69	0.29	6.57
		17	0.47	0.47	0.08	0.60	0.78	0.78	0.13	1.17	1.08	1.08	0.18	2.78	1.39	1.39	0.24	4.69	1.70	1.70	0.29	6.59
		19	-	-	-	-	0.78	0.77	0.13	1.17	1.08	1.08	0.18	2.80	1.39	1.39	0.24	4.71	1.70	1.70	0.29	6.61
		20	-	-	-	-	0.90	0.77	0.15	1.75	1.08	1.08	0.19	2.84	1.39	1.39	0.24	4.71	1.70	1.70	0.29	6.63
6	15	0.32	0.32	0.05	0.33	0.63	0.63	0.09	0.65	0.93	0.93	0.13	1.17	1.22	1.22	0.17	2.45	1.53	1.53	0.22	4.03	
	17	0.32	0.32	0.05	0.33	0.63	0.63	0.09	0.65	0.93	0.93	0.13	1.18	1.22	1.22	0.18	2.46	1.53	1.53	0.22	4.05	
	19	-	-	-	-	0.63	0.63	0.09	0.65	0.93	0.93	0.13	1.18	1.23	1.23	0.18	2.48	1.54	1.54	0.22	4.06	
	20	-	-	-	-	0.65	0.64	0.09	0.68	0.93	0.93	0.13	1.19	1.23	1.23	0.18	2.48	1.54	1.54	0.22	4.07	
15	3	15	0.47	0.47	0.13	1.18	0.78	0.78	0.22	4.13	1.09	1.09	0.31	7.36	1.40	1.40	0.40	11.27	1.71	1.71	0.49	16.04
		17	0.47	0.47	0.13	1.19	0.78	0.78	0.22	4.15	1.09	1.09	0.31	7.38	1.40	1.40	0.40	11.30	1.71	1.71	0.49	16.09
		19	-	-	-	-	0.78	0.78	0.22	4.16	1.10	1.10	0.31	7.41	1.41	1.41	0.40	11.34	1.71	1.71	0.49	16.15
		20	-	-	-	-	0.94	0.78	0.27	5.66	1.10	1.09	0.31	7.44	1.41	1.41	0.40	11.36	1.72	1.72	0.49	16.18
	4	15	0.16	0.16	0.01	0.09	0.62	0.62	0.13	1.20	0.93	0.93	0.20	3.35	1.24	1.24	0.27	5.59	1.55	1.55	0.33	8.15
		17	0.32	0.32	0.07	0.49	0.62	0.62	0.13	1.20	0.93	0.93	0.20	3.36	1.24	1.24	0.27	5.61	1.55	1.55	0.33	8.17
		19	-	-	-	-	0.63	0.63	0.13	1.21	0.93	0.93	0.20	3.37	1.25	1.25	0.27	5.63	1.55	1.55	0.33	8.20
		20	-	-	-	-	0.63	0.63	0.14	1.24	0.93	0.93	0.20	3.38	1.25	1.25	0.27	5.64	1.56	1.56	0.33	8.22
	5	15	0.17	0.17	0.03	0.20	0.48	0.48	0.08	0.57	0.78	0.78	0.13	1.22	1.08	1.08	0.19	2.89	1.39	1.39	0.24	4.65
		17	0.17	0.17	0.03	0.20	0.48	0.48	0.08	0.58	0.78	0.78	0.13	1.23	1.08	1.08	0.19	2.90	1.39	1.39	0.24	4.67
		19	-	-	-	-	0.48	0.48	0.08	0.58	0.78	0.78	0.13	1.24	1.08	1.08	0.19	2.91	1.39	1.39	0.24	4.68
		20	-	-	-	-	0.48	0.48	0.08	0.58	0.78	0.78	0.13	1.24	1.08	1.08	0.19	2.92	1.40	1.40	0.24	4.69
6	15	-	-	-	-	0.32	0.32	0.05	0.32	0.63	0.63	0.09	0.62	0.93	0.93	0.13	1.22	1.22	1.22	0.18	2.55	
	17	-	-	-	-	0.32	0.32	0.05	0.32	0.63	0.63	0.09	0.62	0.93	0.93	0.13	1.23	1.23	1.23	0.18	2.56	
	19	-	-	-	-	0.32	0.32	0.05	0.32	0.63	0.63	0.09	0.63	0.93	0.93	0.13	1.23	1.23	1.23	0.18	2.58	
	20	-	-	-	-	0.32	0.32	0.05	0.32	0.63	0.63	0.09	0.63	0.93	0.93	0.13	1.24	1.23	1.23	0.18	2.59	

Cooling capacity

MDVF-400D3E																						
EWT	ΔT	Indoor temp (W.B.)	Indoor temperature (D.B.)																			
			21				23				25				27				29			
			TC	SC	WF	WPD	TC	SC	WF	WPD	TC	SC	WF	WPD	TC	SC	WF	WPD	TC	SC	WF	WPD
°C	°C	°C	kW	kW	m³/h	kPa	kW	kW	m³/h	kPa	kW	kW	m³/h	kPa	kW	kW	m³/h	kPa	kW	kW	m³/h	kPa
5	3	15	3.25	2.57	0.94	20.20	3.22	2.96	0.93	19.87	3.34	3.34	0.96	21.18	3.72	3.72	1.07	25.50	4.09	4.09	1.17	29.71
		17	4.40	2.58	1.26	33.64	4.37	2.97	1.25	33.24	4.34	3.35	1.24	32.83	4.30	3.73	1.23	32.37	4.27	4.10	1.22	31.90
		19	-	-	-	-	5.60	2.97	1.60	51.26	5.56	3.36	1.60	50.87	5.54	3.74	1.60	50.87	5.50	4.12	1.59	50.28
		20	-	-	-	-	6.27	2.98	1.81	63.24	6.22	3.37	1.80	62.51	6.18	3.75	1.78	61.81	6.13	4.12	1.76	60.17
	4	15	2.76	2.35	0.59	9.24	2.76	2.74	0.59	9.23	3.12	3.12	0.67	11.30	3.51	3.51	0.75	13.77	3.89	3.89	0.84	16.59
		17	3.93	2.36	0.85	16.90	3.90	2.75	0.84	16.69	3.87	3.14	0.83	16.45	3.83	3.52	0.83	16.19	3.89	3.86	0.84	16.58
		19	-	-	-	-	5.12	2.76	1.10	26.46	5.09	3.14	1.09	26.15	5.05	3.52	1.08	25.84	5.02	3.90	1.08	25.53
		20	-	-	-	-	5.78	2.76	1.24	32.64	5.74	3.15	1.23	32.25	5.70	3.53	1.22	31.87	5.66	3.91	1.21	31.50
	5	15	2.23	2.12	0.38	4.26	2.51	2.51	0.43	5.34	2.90	2.90	0.50	6.79	3.29	3.29	0.56	8.40	3.67	3.67	0.63	10.11
		17	3.42	2.14	0.59	8.95	3.39	2.53	0.58	8.82	3.35	2.91	0.57	8.67	3.34	3.30	0.57	8.62	3.68	3.68	0.63	10.15
		19	-	-	-	-	4.64	2.55	0.80	15.26	4.61	2.93	0.79	15.07	4.57	3.31	0.78	14.72	4.53	3.69	0.78	14.52
		20	-	-	-	-	5.30	2.55	0.91	19.14	5.26	2.94	0.91	18.91	5.23	3.32	0.90	18.68	5.19	3.70	0.89	18.46
6	15	1.91	1.90	0.27	1.82	2.29	2.29	0.33	2.96	2.68	2.68	0.38	4.27	3.07	3.07	0.44	5.47	3.45	3.45	0.49	6.68	
	17	2.88	1.91	0.41	4.89	2.85	2.30	0.41	4.79	2.82	2.69	0.40	4.72	3.08	3.08	0.44	5.49	3.46	3.46	0.50	6.70	
	19	-	-	-	-	4.12	2.32	0.59	9.02	4.09	2.71	0.59	8.91	4.06	3.09	0.58	8.78	4.02	3.47	0.58	8.65	
	20	-	-	-	-	4.79	2.33	0.69	11.69	4.75	2.72	0.68	11.55	4.71	3.10	0.68	11.35	4.68	3.48	0.67	11.21	
7	3	15	2.35	2.17	0.67	11.33	2.56	2.56	0.73	13.12	2.95	2.95	0.85	16.94	3.34	3.34	0.96	20.88	3.71	3.71	1.06	24.78
		17	3.51	2.18	1.01	22.57	3.49	2.57	1.00	22.26	3.45	2.96	0.99	21.88	3.43	3.34	0.98	21.64	3.72	3.72	1.07	24.87
		19	-	-	-	-	4.73	2.58	1.37	38.31	4.70	2.97	1.36	37.85	4.66	3.35	1.35	37.38	4.63	3.73	1.34	36.91
		20	-	-	-	-	5.38	2.58	1.55	47.34	5.34	2.97	1.53	46.78	5.30	3.35	1.52	46.22	5.27	3.73	1.51	45.67
	4	15	1.94	1.92	0.42	5.00	2.35	2.35	0.51	6.89	2.74	2.74	0.59	8.95	3.12	3.12	0.67	11.20	3.50	3.50	0.76	13.71
		17	3.01	1.96	0.65	10.52	2.98	2.36	0.64	10.34	2.95	2.74	0.64	10.18	3.13	3.12	0.67	11.24	3.51	3.51	0.76	13.76
		19	-	-	-	-	4.22	2.36	0.91	18.71	4.19	2.75	0.90	18.47	4.15	3.13	0.89	18.23	4.12	3.51	0.89	17.94
		20	-	-	-	-	4.87	2.37	1.05	24.03	4.84	2.76	1.04	23.74	4.80	3.14	1.03	23.44	4.77	3.52	1.03	23.16
	5	15	1.73	1.73	0.30	2.36	2.12	2.12	0.36	3.87	2.52	2.52	0.43	5.26	2.90	2.90	0.50	6.71	3.29	3.29	0.57	8.28
		17	2.45	1.74	0.42	5.04	2.43	2.13	0.42	4.95	2.51	2.49	0.43	5.24	2.91	2.91	0.50	6.73	3.29	3.29	0.57	8.31
		19	-	-	-	-	3.70	2.15	0.64	10.12	3.66	2.54	0.63	9.97	3.62	2.87	0.71	23.67	3.60	3.30	0.62	9.67
		20	-	-	-	-	4.35	2.15	0.75	13.39	4.32	2.54	0.74	13.22	4.29	2.93	0.74	13.05	4.25	3.31	0.73	12.86
6	15	1.55	1.55	0.22	1.10	1.92	1.92	0.28	1.93	2.30	2.30	0.33	3.10	2.69	2.69	0.39	4.30	3.07	3.07	0.44	5.38	
	17	1.91	1.52	0.27	1.92	1.94	1.93	0.28	2.00	2.30	2.30	0.33	3.12	2.69	2.69	0.39	4.32	3.08	3.08	0.44	5.40	
	19	-	-	-	-	3.13	1.92	0.45	5.56	3.10	2.31	0.44	5.47	3.07	2.70	0.44	5.38	3.10	3.09	0.44	5.46	
	20	-	-	-	-	3.80	1.93	0.55	7.74	3.77	2.32	0.54	7.64	3.74	2.71	0.54	7.52	3.70	3.09	0.53	7.40	
9	3	15	1.78	1.78	0.51	6.90	2.17	2.17	0.62	9.72	2.56	2.56	0.73	12.88	2.94	2.94	0.85	16.50	3.32	3.32	0.95	20.20
		17	2.56	1.78	0.74	12.94	2.54	2.17	0.73	12.69	2.56	2.55	0.74	12.92	2.95	2.95	0.85	16.55	3.33	3.33	0.96	20.27
		19	-	-	-	-	3.78	2.18	1.09	25.31	3.75	2.57	1.08	24.97	3.72	2.96	1.07	24.58	3.68	3.34	1.06	24.18
		20	-	-	-	-	4.43	2.18	1.27	33.37	4.40	2.58	1.27	32.95	4.37	2.96	1.26	32.54	4.34	3.34	1.25	32.12
	4	15	1.55	1.55	0.34	3.25	1.95	1.95	0.42	4.93	2.34	2.34	0.50	6.74	2.73	2.73	0.59	8.74	3.11	3.11	0.67	10.94
		17	2.00	1.56	0.43	5.13	2.00	1.95	0.43	5.15	2.35	2.35	0.50	6.76	2.74	2.74	0.59	8.77	3.12	3.12	0.67	10.98
		19	-	-	-	-	3.24	1.97	0.70	11.75	3.21	2.36	0.69	11.56	3.18	2.74	0.68	11.36	3.18	3.13	0.68	11.36
		20	-	-	-	-	3.90	1.97	0.84	16.18	3.87	2.36	0.83	15.96	3.84	2.75	0.83	15.72	3.80	3.13	0.82	15.45
	5	15	1.35	1.35	0.23	1.26	1.73	1.73	0.30	2.44	2.12	2.12	0.37	3.87	2.51	2.51	0.43	5.18	2.90	2.90	0.50	6.59
		17	1.46	1.35	0.25	1.55	1.73	1.73	0.30	2.45	2.13	2.13	0.37	3.88	2.52	2.52	0.43	5.19	2.91	2.91	0.50	6.61
		19	-	-	-	-	2.67	1.75	0.46	5.72	2.64	2.14	0.45	5.61	2.63	2.53	0.45	5.59	2.91	2.91	0.50	6.64
		20	-	-	-	-	3.34	1.76	0.58	8.39	3.31	2.15	0.57	8.26	3.28	2.53	0.56	8.12	3.25	2.92	0.56	8.00
6	15	1.17	1.17	0.17	0.69	1.54	1.54	0.22	1.11	1.91	1.91	0.27	1.99	2.30	2.30	0.33	3.14	2.69	2.69	0.39	4.22	
	17	1.17	1.16	0.17	0.70	1.55	1.55	0.22	1.12	1.92	1.92	0.27	2.00	2.30	2.30	0.33	3.15	2.69	2.69	0.39	4.24	
	19	-	-	-	-	2.05	1.52	0.29	2.40	2.05	1.92	0.29	2.38	2.30	2.30	0.33	3.16	2.70	2.70	0.39	4.25	
	20	-	-	-	-	2.74	1.53	0.39	4.36	2.71	1.92	0.39	4.28	2.68	2.31	0.38	4.20	2.72	2.71	0.39	4.31	

Continued:

MDVF-400D3E																						
EWT	ΔT	Indoor temp (W.B.)	Indoor temperature (D.B.)																			
			21				23				25				27				29			
			TC	SC	WF	WPD	TC	SC	WF	WPD	TC	SC	WF	WPD	TC	SC	WF	WPD	TC	SC	WF	WPD
°C	°C	°C	kW	kW	m³/h	kPa	kW	kW	m³/h	kPa	kW	kW	m³/h	kPa	kW	kW	m³/h	kPa	kW	kW	m³/h	kPa
11	3	15	1.37	1.37	0.39	4.34	1.77	1.77	0.51	6.69	2.16	2.16	0.62	9.41	2.55	2.55	0.73	12.48	2.93	2.93	0.84	15.87
		17	1.53	1.38	0.44	5.23	1.77	1.77	0.51	6.71	2.17	2.17	0.62	9.45	2.56	2.56	0.73	12.53	2.94	2.94	0.84	15.93
		19	-	-	-	-	2.77	1.79	0.79	14.51	2.74	2.18	0.79	14.27	2.73	2.57	0.78	14.13	2.94	2.94	0.84	15.98
		20	-	-	-	-	3.43	1.79	0.98	20.79	3.40	2.18	0.97	20.48	3.36	2.57	0.96	20.12	3.33	2.95	0.95	19.79
	4	15	1.16	1.16	0.25	1.54	1.55	1.55	0.33	3.21	1.95	1.95	0.42	4.81	2.34	2.34	0.50	6.57	2.72	2.72	0.58	8.51
		17	1.16	1.14	0.25	1.54	1.55	1.55	0.33	3.23	1.95	1.95	0.42	4.83	2.34	2.34	0.50	6.59	2.73	2.73	0.58	8.54
		19	-	-	-	-	2.18	1.57	0.47	5.80	2.16	1.96	0.46	5.73	2.35	2.33	0.50	6.60	2.74	2.74	0.59	8.57
		20	-	-	-	-	2.85	1.57	0.61	9.19	2.82	1.97	0.60	9.02	2.79	2.35	0.60	8.86	2.80	2.74	0.60	8.91
	5	15	0.98	0.98	0.17	0.67	1.35	1.35	0.23	1.31	1.73	1.73	0.30	2.53	2.13	2.13	0.37	3.84	2.52	2.52	0.43	5.10
		17	0.98	0.98	0.17	0.68	1.36	1.36	0.23	1.32	1.74	1.74	0.30	2.54	2.13	2.13	0.37	3.85	2.52	2.52	0.43	5.12
		19	-	-	-	-	1.57	1.35	0.27	1.96	1.73	1.71	0.30	2.53	2.14	2.14	0.37	3.86	2.53	2.53	0.44	5.14
		20	-	-	-	-	2.23	1.35	0.38	4.17	2.21	1.75	0.38	4.08	2.22	2.14	0.38	4.11	2.53	2.53	0.44	5.15
6	15	0.78	0.78	0.11	0.44	1.17	1.17	0.17	0.66	1.54	1.54	0.22	1.15	1.91	1.91	0.27	2.06	2.30	2.30	0.33	3.17	
	17	0.78	0.78	0.11	0.44	1.17	1.17	0.17	0.66	1.54	1.54	0.22	1.16	1.92	1.92	0.27	2.07	2.30	2.30	0.33	3.18	
	19	-	-	-	-	1.19	1.18	0.17	0.68	1.55	1.55	0.22	1.16	1.92	1.92	0.28	2.09	2.31	2.31	0.33	3.19	
	20	-	-	-	-	1.63	1.14	0.23	1.33	1.64	1.55	0.24	1.37	1.92	1.91	0.28	2.09	2.31	2.31	0.33	3.20	
13	3	15	0.97	0.97	0.28	2.16	1.38	1.38	0.39	4.34	1.77	1.77	0.51	6.67	2.16	2.16	0.62	9.37	2.55	2.55	0.73	12.41
		17	0.98	0.98	0.28	2.17	1.38	1.38	0.40	4.35	1.77	1.77	0.51	6.69	2.17	2.17	0.62	9.40	2.55	2.55	0.73	12.46
		19	-	-	-	-	1.67	1.38	0.48	6.02	1.77	1.74	0.51	6.65	2.17	2.17	0.62	9.44	2.56	2.56	0.73	12.50
		20	-	-	-	-	2.33	1.39	0.67	10.68	2.30	1.78	0.66	10.46	2.30	2.17	0.66	10.41	2.56	2.55	0.73	12.52
	4	15	0.78	0.78	0.17	0.66	1.16	1.16	0.25	1.63	1.55	1.55	0.33	3.25	1.95	1.95	0.42	4.78	2.33	2.33	0.50	6.44
		17	0.79	0.79	0.17	0.66	1.16	1.16	0.25	1.63	1.56	1.56	0.34	3.26	1.95	1.95	0.42	4.80	2.34	2.34	0.50	6.46
		19	-	-	-	-	1.16	1.13	0.25	1.61	1.56	1.56	0.34	3.27	1.96	1.96	0.42	4.82	2.34	2.34	0.50	6.49
		20	-	-	-	-	1.69	1.17	0.36	3.76	1.69	1.56	0.36	3.75	1.96	1.94	0.42	4.82	2.35	2.35	0.50	6.50
	5	15	0.59	0.59	0.10	0.38	0.97	0.97	0.17	0.64	1.35	1.35	0.23	1.33	1.73	1.73	0.30	2.54	2.12	2.12	0.36	3.74
		17	0.59	0.59	0.10	0.38	0.98	0.98	0.17	0.64	1.35	1.35	0.23	1.34	1.73	1.73	0.30	2.56	2.13	2.13	0.36	3.75
		19	-	-	-	-	0.98	0.98	0.17	0.64	1.35	1.35	0.23	1.35	1.74	1.74	0.30	2.57	2.13	2.13	0.37	3.77
		20	-	-	-	-	1.12	0.97	0.19	0.82	1.35	1.34	0.23	1.34	1.74	1.74	0.30	2.57	2.13	2.13	0.37	3.78
6	15	0.40	0.40	0.06	0.21	0.78	0.78	0.11	0.42	1.17	1.17	0.17	0.63	1.54	1.54	0.22	1.18	1.91	1.91	0.27	2.10	
	17	0.40	0.40	0.06	0.21	0.78	0.78	0.11	0.42	1.17	1.17	0.17	0.63	1.54	1.54	0.22	1.18	1.91	1.91	0.27	2.11	
	19	-	-	-	-	0.79	0.79	0.11	0.42	1.17	1.17	0.17	0.64	1.54	1.54	0.22	1.19	1.92	1.92	0.27	2.12	
	20	-	-	-	-	0.79	0.79	0.11	0.42	1.17	1.17	0.17	0.64	1.54	1.54	0.22	1.19	1.92	1.92	0.27	2.13	
15	3	15	0.59	0.59	0.17	0.64	0.97	0.97	0.28	2.17	1.37	1.37	0.39	4.20	1.77	1.77	0.50	6.46	2.15	2.15	0.61	9.07
		17	0.59	0.59	0.17	0.64	0.97	0.97	0.28	2.18	1.37	1.37	0.39	4.22	1.77	1.77	0.50	6.48	2.16	2.16	0.62	9.10
		19	-	-	-	-	0.97	0.97	0.28	2.19	1.38	1.38	0.39	4.23	1.77	1.77	0.51	6.50	2.16	2.16	0.62	9.14
		20	-	-	-	-	1.13	0.98	0.32	3.01	1.37	1.36	0.39	4.22	1.77	1.77	0.51	6.52	2.16	2.16	0.62	9.15
	4	15	0.39	0.39	0.08	0.31	0.78	0.78	0.17	0.63	1.16	1.16	0.25	1.65	1.55	1.55	0.33	3.18	1.94	1.94	0.42	4.65
		17	0.40	0.40	0.08	0.31	0.78	0.78	0.17	0.63	1.16	1.16	0.25	1.66	1.56	1.56	0.33	3.19	1.95	1.95	0.42	4.67
		19	-	-	-	-	0.79	0.79	0.17	0.63	1.16	1.16	0.25	1.67	1.56	1.56	0.33	3.20	1.95	1.95	0.42	4.69
		20	-	-	-	-	0.78	0.76	0.17	0.63	1.16	1.16	0.25	1.68	1.56	1.56	0.33	3.21	1.96	1.96	0.42	4.70
	5	15	0.20	0.20	0.03	0.12	0.59	0.59	0.10	0.37	0.98	0.98	0.17	0.63	1.35	1.35	0.23	1.40	1.73	1.73	0.30	2.60
		17	0.20	0.20	0.03	0.12	0.59	0.59	0.10	0.37	0.98	0.98	0.17	0.63	1.35	1.35	0.23	1.41	1.74	1.74	0.30	2.61
		19	-	-	-	-	0.59	0.59	0.10	0.37	0.98	0.98	0.17	0.64	1.35	1.35	0.23	1.42	1.74	1.74	0.30	2.63
		20	-	-	-	-	0.59	0.59	0.10	0.37	0.98	0.98	0.17	0.64	1.36	1.36	0.23	1.42	1.74	1.74	0.30	2.63
6	15	-	-	-	-	0.40	0.40	0.06	0.20	0.78	0.78	0.11	0.40	1.17	1.17	0.17	0.62	1.53	1.53	0.22	1.23	
	17	-	-	-	-	0.40	0.40	0.06	0.20	0.79	0.79	0.11	0.40	1.17	1.17	0.17	0.63	1.54	1.54	0.22	1.24	
	19	-	-	-	-	0.40	0.40	0.06	0.20	0.79	0.79	0.11	0.40	1.17	1.17	0.17	0.63	1.54	1.54	0.22	1.24	
	20	-	-	-	-	0.40	0.40	0.06	0.20	0.79	0.79	0.11	0.40	1.17	1.17	0.17	0.63	1.54	1.54	0.22	1.25	

Cooling capacity

MDVF-500D3E																						
EWT	ΔT	Indoor temp (W.B.)	Indoor temperature (D.B.)																			
			21				23				25				27				29			
			TC	SC	WF	WPD	TC	SC	WF	WPD	TC	SC	WF	WPD	TC	SC	WF	WPD	TC	SC	WF	WPD
°C	°C	°C	kW	kW	m³/h	kPa	kW	kW	m³/h	kPa	kW	kW	m³/h	kPa	kW	kW	m³/h	kPa	kW	kW	m³/h	kPa
5	3	15	3.91	3.10	1.12	27.42	3.88	3.56	1.11	27.10	4.03	4.02	1.15	28.86	4.49	4.49	1.28	34.86	4.94	4.94	1.42	41.51
		17	5.31	3.11	1.53	47.33	5.27	3.58	1.52	46.77	5.23	4.04	1.50	45.87	5.20	4.50	1.49	45.27	5.15	4.95	1.47	44.29
		19	-	-	-	-	6.75	3.58	1.93	71.20	6.71	4.05	1.92	70.41	6.66	4.51	1.91	69.62	6.62	4.96	1.90	68.85
		20	-	-	-	-	7.54	3.59	2.16	86.55	7.49	4.05	2.15	85.59	7.44	4.51	2.14	84.65	7.40	4.97	2.12	83.73
	4	15	3.33	2.83	0.71	12.59	3.34	3.31	0.72	12.70	3.77	3.77	0.81	15.61	4.23	4.23	0.91	19.24	4.68	4.68	1.00	22.69
		17	4.72	2.84	1.01	22.99	4.69	3.31	1.00	22.71	4.65	3.78	1.00	22.41	4.62	4.24	1.00	22.39	4.69	4.69	1.01	22.77
		19	-	-	-	-	6.18	3.32	1.33	36.66	6.14	3.79	1.32	36.25	6.10	4.25	1.31	35.83	6.06	4.71	1.30	35.43
		20	-	-	-	-	6.97	3.33	1.50	45.23	6.92	3.79	1.49	44.73	6.88	4.26	1.48	44.23	6.83	4.71	1.47	43.74
	5	15	2.71	2.56	0.47	6.07	3.04	3.04	0.52	7.34	3.51	3.51	0.60	9.38	3.97	3.97	0.68	11.60	4.43	4.43	0.76	13.98
		17	4.13	2.58	0.71	12.39	4.10	3.05	0.70	12.22	4.06	3.52	0.70	12.02	4.06	3.98	0.70	12.06	4.44	4.44	0.76	14.03
		19	-	-	-	-	5.59	3.06	0.96	20.85	5.56	3.53	0.96	20.82	5.53	4.00	0.95	20.58	5.49	4.45	0.95	20.32
		20	-	-	-	-	6.38	3.07	1.09	26.18	6.34	3.53	1.09	25.88	6.29	4.00	1.08	25.59	6.25	4.46	1.07	25.30
6	15	2.29	2.28	0.33	2.95	2.77	2.77	0.40	4.56	3.25	3.25	0.47	6.02	3.72	3.72	0.53	7.57	4.18	4.18	0.60	9.24	
	17	3.50	2.31	0.50	6.84	3.46	2.79	0.50	6.72	3.45	3.25	0.49	6.66	3.72	3.72	0.53	7.59	4.19	4.19	0.60	9.27	
	19	-	-	-	-	4.99	2.81	0.72	12.55	4.96	3.28	0.71	12.40	4.92	3.74	0.71	12.24	4.88	4.20	0.70	12.06	
	20	-	-	-	-	5.78	2.81	0.83	16.16	5.74	3.28	0.82	15.97	5.70	3.75	0.82	15.79	5.66	4.21	0.81	15.60	
7	3	15	2.86	2.63	0.82	15.99	3.10	3.09	0.89	18.37	3.56	3.56	1.02	23.07	4.02	4.02	1.16	28.93	4.48	4.48	1.30	34.86
		17	4.25	2.63	1.23	31.79	4.22	3.10	1.22	31.39	4.18	3.57	1.21	30.90	4.16	4.03	1.20	30.60	4.49	4.49	1.30	34.97
		19	-	-	-	-	5.69	3.11	1.64	52.34	5.66	3.58	1.63	52.01	5.62	4.04	1.62	51.55	5.58	4.49	1.60	50.37
		20	-	-	-	-	6.49	3.11	1.87	66.29	6.44	3.58	1.86	65.35	6.40	4.04	1.84	64.37	6.36	4.50	1.83	63.53
	4	15	2.36	2.35	0.51	6.95	2.83	2.83	0.61	9.51	3.31	3.31	0.71	12.43	3.77	3.77	0.81	15.57	4.22	4.22	0.91	18.77
		17	3.64	2.37	0.79	14.66	3.60	2.84	0.78	14.41	3.58	3.31	0.77	14.22	3.77	3.77	0.82	15.61	4.23	4.23	0.91	18.82
		19	-	-	-	-	5.09	2.85	1.09	25.91	5.05	3.32	1.09	25.60	5.02	3.78	1.08	25.29	4.97	4.24	1.07	24.91
		20	-	-	-	-	5.89	2.86	1.27	33.71	5.85	3.33	1.27	33.32	5.81	3.79	1.26	32.93	5.77	4.25	1.25	32.55
	5	15	2.08	2.08	0.36	3.72	2.57	2.57	0.44	5.45	3.04	3.04	0.52	7.27	3.51	3.51	0.60	9.27	3.97	3.97	0.68	11.45
		17	2.98	2.10	0.51	7.02	2.95	2.58	0.51	6.90	3.06	3.06	0.53	7.35	3.52	3.52	0.60	9.30	3.98	3.98	0.68	11.48
		19	-	-	-	-	4.46	2.59	0.77	13.99	4.43	3.06	0.76	13.81	4.39	3.44	0.79	32.00	4.36	3.99	0.75	13.41
		20	-	-	-	-	5.25	2.59	0.90	18.51	5.22	3.06	0.90	18.28	5.18	3.53	0.89	18.06	5.14	3.99	0.88	17.82
6	15	1.84	1.84	0.27	1.74	2.30	2.30	0.33	3.12	2.78	2.78	0.40	4.53	3.25	3.25	0.47	5.93	3.72	3.72	0.53	7.45	
	17	2.28	1.83	0.33	3.05	2.34	2.31	0.34	3.25	2.78	2.78	0.40	4.55	3.26	3.26	0.47	5.95	3.72	3.72	0.53	7.47	
	19	-	-	-	-	3.81	2.33	0.55	7.75	3.77	2.80	0.54	7.62	3.73	3.27	0.53	7.50	3.80	3.74	0.54	7.74	
	20	-	-	-	-	4.61	2.34	0.66	10.74	4.57	2.81	0.66	10.60	4.53	3.28	0.65	10.45	4.49	3.74	0.64	10.28	
9	3	15	2.14	2.14	0.62	9.52	2.62	2.62	0.75	13.41	3.09	3.09	0.89	17.79	3.55	3.55	1.02	22.68	4.01	4.01	1.16	28.42
		17	3.09	2.15	0.89	17.88	3.06	2.62	0.88	17.53	3.11	3.10	0.89	18.01	3.56	3.56	1.02	22.75	4.02	4.02	1.16	28.51
		19	-	-	-	-	4.56	2.63	1.31	35.04	4.53	3.10	1.30	34.60	4.49	3.56	1.29	34.08	4.45	4.02	1.28	33.55
		20	-	-	-	-	5.36	2.64	1.55	47.08	5.32	3.11	1.54	46.51	5.29	3.57	1.53	45.97	5.25	4.04	1.52	45.41
	4	15	1.87	1.87	0.40	4.61	2.36	2.36	0.51	6.81	2.83	2.83	0.61	9.31	3.30	3.30	0.71	12.10	3.76	3.76	0.81	15.15
		17	2.43	1.88	0.52	7.16	2.45	2.37	0.53	7.26	2.84	2.84	0.61	9.34	3.30	3.30	0.71	12.13	3.77	3.77	0.81	15.20
		19	-	-	-	-	3.92	2.37	0.84	16.31	3.89	2.84	0.84	16.05	3.85	3.31	0.83	15.78	3.87	3.78	0.83	15.91
		20	-	-	-	-	4.71	2.38	1.02	22.49	4.68	2.85	1.01	22.21	4.64	3.32	1.00	21.91	4.60	3.78	0.99	21.57
	5	15	1.62	1.62	0.28	2.03	2.09	2.09	0.36	3.76	2.57	2.57	0.44	5.38	3.04	3.04	0.52	7.16	3.51	3.51	0.60	9.13
		17	1.74	1.61	0.30	2.47	2.09	2.09	0.36	3.77	2.58	2.58	0.44	5.39	3.05	3.05	0.52	7.18	3.51	3.51	0.60	9.15
		19	-	-	-	-	3.24	2.11	0.56	7.97	3.20	2.58	0.55	7.81	3.21	3.06	0.55	7.85	3.52	3.51	0.61	9.18
		20	-	-	-	-	4.04	2.12	0.70	11.64	4.01	2.59	0.69	11.47	3.97	3.06	0.68	11.27	3.94	3.52	0.68	11.12
6	15	1.40	1.40	0.20	0.89	1.84	1.84	0.26	1.79	2.30	2.30	0.33	3.17	2.78	2.78	0.40	4.49	3.25	3.25	0.47	5.85	
	17	1.41	1.41	0.20	0.91	1.85	1.85	0.26	1.80	2.31	2.31	0.33	3.18	2.79	2.79	0.40	4.51	3.26	3.26	0.47	5.87	
	19	-	-	-	-	2.49	1.84	0.36	3.71	2.50	2.32	0.36	3.72	2.79	2.78	0.40	4.52	3.27	3.27	0.47	5.89	
	20	-	-	-	-	3.33	1.86	0.48	6.10	3.30	2.33	0.47	5.98	3.27	2.80	0.47	5.89	3.35	3.28	0.48	6.15	

Continued:

MDVF-500D3E																							
EWT	ΔT	Indoor temp (W.B.)	Indoor temperature (D.B.)																				
			21				23				25				27				29				
°C	°C	°C	TC	SC	WF	WPD	TC	SC	WF	WPD	TC	SC	WF	WPD	TC	SC	WF	WPD	TC	SC	WF	WPD	
			kW	kW	m³/h	kPa	kW	kW	m³/h	kPa	kW	kW	m³/h	kPa	kW	kW	m³/h	kPa	kW	kW	m³/h	kPa	
11	3	15	1.66	1.66	0.47	6.00	2.14	2.14	0.61	9.24	2.61	2.61	0.75	13.02	3.08	3.08	0.88	17.28	3.54	3.54	1.01	22.02	
		17	1.86	1.66	0.53	7.29	2.14	2.13	0.61	9.26	2.62	2.62	0.75	13.06	3.09	3.09	0.88	17.33	3.55	3.55	1.01	22.09	
		19	-	-	-	-	3.34	2.15	0.95	19.91	3.30	2.62	0.94	19.52	3.29	3.09	0.94	19.35	3.55	3.55	1.01	22.15	
		20	-	-	-	-	4.13	2.15	1.18	28.80	4.11	2.63	1.18	28.62	4.07	3.10	1.17	28.19	4.03	3.56	1.15	27.66	
	4	15	1.39	1.39	0.30	2.50	1.88	1.88	0.40	4.53	2.36	2.36	0.51	6.66	2.83	2.83	0.61	9.08	3.29	3.29	0.71	11.79	
		17	1.39	1.37	0.30	2.49	1.88	1.88	0.40	4.54	2.36	2.36	0.51	6.68	2.83	2.83	0.61	9.11	3.30	3.30	0.71	11.82	
		19	-	-	-	-	2.64	1.89	0.57	8.07	2.63	2.37	0.56	7.99	2.84	2.83	0.61	9.15	3.31	3.31	0.71	11.86	
		20	-	-	-	-	3.45	1.90	0.74	12.75	3.41	2.37	0.73	12.52	3.38	2.84	0.72	12.30	3.41	3.31	0.73	12.50	
	5	15	1.18	1.18	0.20	0.91	1.62	1.62	0.28	2.13	2.10	2.10	0.36	3.76	2.58	2.58	0.44	5.32	3.05	3.05	0.52	7.06	
		17	1.18	1.18	0.20	0.91	1.62	1.62	0.28	2.14	2.10	2.10	0.36	3.77	2.58	2.58	0.44	5.33	3.05	3.05	0.53	7.09	
		19	-	-	-	-	1.90	1.62	0.33	3.10	2.11	2.11	0.36	3.80	2.59	2.59	0.45	5.35	3.06	3.06	0.53	7.11	
		20	-	-	-	-	2.72	1.64	0.47	5.82	2.69	2.11	0.46	5.71	2.72	2.59	0.47	5.84	3.06	3.05	0.53	7.12	
	6	15	0.94	0.94	0.14	0.53	1.40	1.40	0.20	0.90	1.84	1.84	0.26	1.87	2.31	2.31	0.33	3.21	2.79	2.79	0.40	4.44	
		17	0.94	0.94	0.14	0.53	1.41	1.41	0.20	0.91	1.85	1.85	0.27	1.88	2.32	2.32	0.33	3.22	2.80	2.80	0.40	4.46	
		19	-	-	-	-	1.45	1.41	0.21	0.97	1.85	1.85	0.27	1.89	2.32	2.32	0.33	3.23	2.80	2.80	0.40	4.47	
		20	-	-	-	-	1.92	1.37	0.28	2.09	1.96	1.85	0.28	2.20	2.32	2.31	0.33	3.23	2.80	2.80	0.40	4.48	
	13	3	15	1.18	1.18	0.34	3.33	1.66	1.66	0.48	6.00	2.14	2.14	0.61	9.22	2.61	2.61	0.74	12.77	3.08	3.08	0.88	17.22
			17	1.18	1.18	0.34	3.34	1.67	1.67	0.48	6.02	2.14	2.14	0.62	9.25	2.61	2.61	0.74	12.81	3.08	3.08	0.89	17.27
			19	-	-	-	-	2.03	1.67	0.58	8.38	2.16	2.15	0.62	9.33	2.62	2.62	0.75	12.85	3.09	3.09	0.89	17.34
			20	-	-	-	-	2.81	1.67	0.80	14.55	2.77	2.15	0.79	14.22	2.78	2.62	0.79	14.24	3.09	3.08	0.89	17.35
		4	15	0.94	0.94	0.20	0.92	1.40	1.40	0.30	2.62	1.88	1.88	0.41	4.52	2.36	2.36	0.50	6.54	2.82	2.82	0.61	8.92
			17	0.94	0.94	0.20	0.92	1.40	1.40	0.30	2.63	1.89	1.89	0.41	4.53	2.36	2.36	0.51	6.56	2.83	2.83	0.61	8.95
			19	-	-	-	-	1.40	1.39	0.30	2.65	1.89	1.89	0.41	4.55	2.36	2.36	0.51	6.59	2.83	2.83	0.61	8.98
			20	-	-	-	-	2.05	1.41	0.44	5.14	2.06	1.89	0.44	5.19	2.36	2.35	0.51	6.59	2.84	2.84	0.61	9.00
5		15	0.71	0.71	0.12	0.46	1.17	1.17	0.20	0.91	1.62	1.62	0.28	2.17	2.10	2.10	0.36	3.67	2.57	2.57	0.44	5.19	
		17	0.71	0.71	0.12	0.46	1.17	1.17	0.20	0.91	1.62	1.62	0.28	2.18	2.10	2.10	0.36	3.68	2.58	2.58	0.44	5.21	
		19	-	-	-	-	1.17	1.17	0.20	0.91	1.62	1.62	0.28	2.19	2.11	2.11	0.36	3.70	2.58	2.58	0.44	5.22	
		20	-	-	-	-	1.32	1.16	0.23	1.25	1.62	1.61	0.28	2.19	2.11	2.11	0.36	3.70	2.59	2.59	0.44	5.23	
6		15	0.48	0.48	0.07	0.25	0.94	0.94	0.13	0.50	1.40	1.40	0.20	0.91	1.84	1.84	0.26	1.92	2.32	2.32	0.33	3.17	
		17	0.48	0.48	0.07	0.25	0.95	0.95	0.14	0.50	1.40	1.40	0.20	0.92	1.85	1.85	0.26	1.93	2.32	2.32	0.33	3.18	
		19	-	-	-	-	0.95	0.95	0.14	0.51	1.40	1.40	0.20	0.92	1.85	1.85	0.26	1.94	2.33	2.33	0.33	3.19	
		20	-	-	-	-	0.96	0.96	0.14	0.51	1.41	1.41	0.20	0.92	1.85	1.85	0.27	1.94	2.33	2.33	0.33	3.20	
15		3	15	0.71	0.71	0.20	0.92	1.18	1.18	0.34	3.24	1.66	1.66	0.47	5.82	2.13	2.13	0.61	8.94	2.60	2.60	0.74	12.57
			17	0.71	0.71	0.20	0.93	1.18	1.18	0.34	3.25	1.66	1.66	0.47	5.84	2.14	2.14	0.61	8.97	2.61	2.61	0.74	12.61
			19	-	-	-	-	1.18	1.18	0.34	3.26	1.67	1.67	0.48	5.86	2.14	2.14	0.61	9.00	2.61	2.61	0.75	12.66
			20	-	-	-	-	1.38	1.18	0.39	4.27	1.66	1.65	0.47	5.84	2.15	2.15	0.61	9.02	2.62	2.62	0.75	12.68
		4	15	0.48	0.48	0.10	0.37	0.94	0.94	0.20	0.93	1.40	1.40	0.30	2.62	1.88	1.88	0.40	4.41	2.36	2.36	0.50	6.45
			17	0.48	0.48	0.10	0.38	0.94	0.94	0.20	0.94	1.40	1.40	0.30	2.63	1.89	1.89	0.40	4.42	2.36	2.36	0.51	6.47
			19	-	-	-	-	0.94	0.94	0.20	0.94	1.40	1.40	0.30	2.65	1.89	1.89	0.41	4.44	2.36	2.36	0.51	6.50
			20	-	-	-	-	0.94	0.93	0.20	0.94	1.41	1.41	0.30	2.65	1.89	1.89	0.41	4.45	2.37	2.37	0.51	6.51
	5	15	0.24	0.24	0.04	0.15	0.71	0.71	0.12	0.44	1.17	1.17	0.20	0.95	1.63	1.63	0.28	2.27	2.11	2.11	0.36	3.66	
		17	0.25	0.25	0.04	0.15	0.72	0.72	0.12	0.45	1.17	1.17	0.20	0.96	1.63	1.63	0.28	2.28	2.11	2.11	0.36	3.68	
		19	-	-	-	-	0.72	0.72	0.12	0.45	1.18	1.18	0.20	0.96	1.63	1.63	0.28	2.29	2.11	2.11	0.36	3.69	
		20	-	-	-	-	0.72	0.72	0.12	0.45	1.18	1.18	0.20	0.97	1.63	1.63	0.28	2.29	2.12	2.12	0.36	3.70	
	6	15	-	-	-	-	0.48	0.48	0.07	0.24	0.95	0.95	0.14	0.48	1.40	1.40	0.20	0.95	1.85	1.85	0.27	2.00	
		17	-	-	-	-	0.48	0.48	0.07	0.24	0.95	0.95	0.14	0.48	1.40	1.40	0.20	0.96	1.85	1.85	0.27	2.01	
		19	-	-	-	-	0.48	0.48	0.07	0.25	0.95	0.95	0.14	0.48	1.40	1.40	0.20	0.96	1.85	1.85	0.27	2.02	
		20	-	-	-	-	0.48	0.48	0.07	0.25	0.95	0.95	0.14	0.48	1.41	1.41	0.20	0.97	1.86	1.86	0.27	2.03	

Cooling capacity

MDVF-600D3E																							
EWT	ΔT	Indoor temp (W.B.)	Indoor temperature (D.B.)																				
			21				23				25				27				29				
			TC	SC	WF	WPD	TC	SC	WF	WPD	TC	SC	WF	WPD	TC	SC	WF	WPD	TC	SC	WF	WPD	
°C	°C	°C	kW	kW	m³/h	kPa	kW	kW	m³/h	kPa	kW	kW	m³/h	kPa	kW	kW	m³/h	kPa	kW	kW	m³/h	kPa	
5	3	15	5.11	3.99	1.46	56.68	5.06	4.58	1.45	55.84	5.17	5.17	1.48	58.02	5.73	5.73	1.64	69.44	6.30	6.30	1.81	82.00	
		17	6.86	4.00	1.97	95.33	6.81	4.59	1.96	94.12	6.77	5.17	1.95	93.73	6.72	5.75	1.94	93.04	6.67	6.32	1.93	91.99	
		19	-	-	-	-	8.69	4.61	2.51	145.38	8.64	5.19	2.50	144.64	8.58	5.77	2.50	144.15	8.52	6.33	2.46	141.02	
		20	-	-	-	-	9.68	4.61	2.79	175.83	9.62	5.20	2.78	173.75	9.55	5.77	2.76	171.59	9.49	6.34	2.74	169.56	
	4	15	4.43	3.68	0.95	26.68	4.44	4.28	0.95	26.87	4.85	4.85	1.04	31.31	5.43	5.43	1.17	38.03	6.00	6.00	1.29	45.26	
		17	6.19	3.69	1.33	47.82	6.15	4.28	1.32	47.16	6.09	4.87	1.31	46.45	6.04	5.44	1.30	45.83	6.11	6.02	1.31	46.65	
		19	-	-	-	-	8.04	4.30	1.74	76.10	7.98	4.89	1.73	75.18	7.92	5.47	1.71	74.25	7.86	6.04	1.70	73.29	
		20	-	-	-	-	9.02	4.31	1.94	92.69	8.97	4.90	1.94	92.40	8.91	5.48	1.93	91.27	8.85	6.04	1.91	90.14	
	5	15	3.75	3.37	0.64	13.62	4.00	3.98	0.69	15.32	4.56	4.56	0.79	19.16	5.13	5.13	0.88	23.31	5.70	5.70	0.98	27.97	
		17	5.50	3.38	0.94	26.25	5.45	3.98	0.93	25.83	5.40	4.56	0.93	25.46	5.41	5.15	0.93	25.58	5.72	5.71	0.98	28.09	
		19	-	-	-	-	7.34	3.99	1.26	43.28	7.28	4.58	1.25	42.71	7.22	5.15	1.24	42.14	7.16	5.73	1.23	41.54	
		20	-	-	-	-	8.33	4.00	1.43	54.06	8.27	4.59	1.42	53.38	8.21	5.17	1.41	52.72	8.16	5.74	1.40	52.08	
	6	15	3.17	3.07	0.45	7.49	3.66	3.66	0.52	9.56	4.25	4.25	0.61	12.38	4.83	4.83	0.69	15.41	5.40	5.40	0.77	18.53	
		17	4.78	3.08	0.69	15.11	4.74	3.67	0.68	14.87	4.73	4.26	0.68	14.83	4.93	4.85	0.71	15.93	5.41	5.41	0.77	18.60	
		19	-	-	-	-	6.63	3.69	0.95	26.35	6.58	4.27	0.94	25.97	6.52	4.85	0.93	25.58	6.47	5.43	0.93	25.23	
		20	-	-	-	-	7.64	3.70	1.10	33.89	7.58	4.29	1.09	33.46	7.53	4.87	1.08	33.02	7.47	5.44	1.07	32.55	
	7	3	15	3.78	3.39	1.09	33.60	3.98	3.98	1.15	36.88	4.56	4.56	1.31	46.09	5.14	5.14	1.48	57.22	5.71	5.71	1.65	68.86
			17	5.52	3.39	1.59	64.58	5.47	3.98	1.57	63.41	5.43	4.57	1.57	62.95	5.41	5.15	1.56	62.52	5.72	5.72	1.65	69.10
			19	-	-	-	-	7.35	4.00	2.12	107.00	7.30	4.58	2.11	105.60	7.25	5.16	2.09	104.26	7.19	5.73	2.07	102.70
			20	-	-	-	-	8.35	4.01	2.42	134.71	8.31	4.60	2.42	134.72	8.25	5.18	2.40	133.09	8.18	5.75	2.37	129.78
4		15	3.17	3.09	0.69	15.03	3.67	3.67	0.79	19.11	4.26	4.26	0.92	24.69	4.84	4.84	1.05	31.15	5.41	5.41	1.16	37.37	
		17	4.81	3.09	1.04	30.81	4.77	3.68	1.03	30.29	4.74	4.27	1.03	30.02	4.90	4.86	1.06	31.82	5.42	5.42	1.17	37.51	
		19	-	-	-	-	6.66	3.70	1.44	54.19	6.61	4.28	1.43	53.46	6.55	4.86	1.42	52.66	6.49	5.44	1.41	51.89	
		20	-	-	-	-	7.64	3.70	1.65	68.74	7.58	4.29	1.64	67.43	7.53	4.87	1.62	66.56	7.47	5.44	1.61	65.61	
5		15	2.77	2.76	0.48	8.01	3.37	3.37	0.58	11.18	3.96	3.96	0.68	14.76	4.54	4.54	0.78	18.65	5.11	5.11	0.88	22.92	
		17	4.05	2.78	0.70	15.40	4.03	3.37	0.69	15.20	4.13	3.98	0.71	15.93	4.55	4.54	0.78	18.72	5.12	5.12	0.88	23.00	
		19	-	-	-	-	5.93	3.39	1.02	29.77	5.87	3.98	1.02	29.33	5.77	4.39	1.04	29.33	5.79	5.14	1.00	28.59	
		20	-	-	-	-	6.91	3.39	1.19	38.60	6.86	3.98	1.18	38.08	6.80	4.57	1.17	37.53	6.74	5.14	1.16	36.96	
6		15	2.44	2.44	0.35	4.62	3.05	3.05	0.44	6.91	3.65	3.65	0.52	9.36	4.24	4.24	0.61	12.07	4.82	4.82	0.69	15.03	
		17	3.26	2.46	0.47	7.73	3.33	3.07	0.48	7.99	3.68	3.67	0.53	9.48	4.25	4.25	0.61	12.12	4.83	4.83	0.69	15.08	
		19	-	-	-	-	5.15	3.08	0.74	16.85	5.10	3.67	0.73	16.56	5.06	4.25	0.73	16.38	5.14	4.85	0.74	16.82	
		20	-	-	-	-	6.17	3.09	0.89	23.11	6.10	3.68	0.88	22.63	6.05	4.26	0.87	22.28	6.00	4.84	0.86	21.97	
9		3	15	2.77	2.77	0.80	19.19	3.38	3.38	0.98	27.33	3.96	3.96	1.14	35.55	4.55	4.55	1.32	45.84	5.11	5.11	1.47	55.61
			17	4.07	2.78	1.17	37.24	4.03	3.37	1.16	36.66	4.08	3.98	1.17	37.43	4.55	4.55	1.32	46.00	5.12	5.12	1.47	55.82
			19	-	-	-	-	5.94	3.40	1.72	73.29	5.89	3.98	1.71	72.18	5.82	4.56	1.67	69.58	5.77	5.13	1.66	68.82
			20	-	-	-	-	6.92	3.40	2.00	94.82	6.87	3.99	1.99	94.30	6.83	4.58	1.99	93.90	6.77	5.15	1.97	92.49
	4	15	2.47	2.47	0.53	9.54	3.07	3.07	0.66	13.96	3.66	3.66	0.79	18.86	4.25	4.25	0.92	24.47	4.82	4.82	1.04	30.16	
		17	3.30	2.47	0.71	15.70	3.33	3.08	0.72	15.92	3.67	3.67	0.79	18.96	4.26	4.26	0.92	24.56	4.83	4.83	1.04	30.27	
		19	-	-	-	-	5.16	3.08	1.11	33.95	5.11	3.67	1.10	33.37	5.07	4.26	1.09	32.89	5.09	4.85	1.10	33.22	
		20	-	-	-	-	6.17	3.09	1.34	46.78	6.13	3.69	1.33	46.25	6.07	4.27	1.32	45.53	6.02	4.85	1.30	44.84	
	5	15	2.15	2.15	0.37	5.14	2.76	2.76	0.48	7.86	3.36	3.36	0.58	10.97	3.95	3.95	0.68	14.53	4.52	4.52	0.78	18.30	
		17	2.52	2.16	0.43	6.71	2.81	2.78	0.48	8.11	3.36	3.36	0.58	11.01	3.96	3.96	0.68	14.58	4.53	4.53	0.78	18.36	
		19	-	-	-	-	4.36	2.78	0.75	17.18	4.33	3.37	0.74	16.93	4.35	3.96	0.75	17.09	4.61	4.55	0.79	18.89	
		20	-	-	-	-	5.38	2.78	0.93	24.65	5.32	3.38	0.92	24.23	5.28	3.97	0.91	23.85	5.25	4.55	0.90	23.65	
	6	15	1.85	1.85	0.26	2.36	2.45	2.45	0.35	4.64	3.05	3.05	0.44	6.80	3.64	3.64	0.52	9.19	4.23	4.23	0.61	11.84	
		17	1.93	1.86	0.28	2.65	2.45	2.45	0.35	4.66	3.06	3.06	0.44	6.82	3.65	3.65	0.52	9.22	4.24	4.24	0.61	11.88	
		19	-	-	-	-	3.53	2.46	0.51	8.70	3.55	3.07	0.51	8.77	3.79	3.67	0.54	9.83	4.24	4.24	0.61	11.93	
		20	-	-	-	-	4.55	2.47	0.65	13.40	4.50	3.07	0.65	13.17	4.48	3.66	0.64	13.06	4.58	4.26	0.66	13.56	

Continued:

MDVF-600D3E																							
EWT	ΔT	Indoor temp (W.B.)	Indoor temperature (D.B.)																				
			21				23				25				27				29				
			TC	SC	WF	WPD	TC	SC	WF	WPD	TC	SC	WF	WPD	TC	SC	WF	WPD	TC	SC	WF	WPD	
°C	°C	°C	kW	kW	m³/h	kPa	kW	kW	m³/h	kPa	kW	kW	m³/h	kPa	kW	kW	m³/h	kPa	kW	kW	m³/h	kPa	
11	3	15	2.16	2.16	0.62	12.21	2.76	2.76	0.79	18.62	3.36	3.36	0.96	26.06	3.95	3.95	1.13	34.69	4.52	4.52	1.29	43.69	
		17	2.53	2.17	0.72	15.96	2.79	2.78	0.79	18.85	3.37	3.37	0.96	26.16	3.95	3.95	1.13	34.82	4.53	4.53	1.29	43.85	
		19	-	-	-	-	4.39	2.78	1.26	41.99	4.35	3.38	1.25	41.28	4.33	3.97	1.25	41.08	4.55	4.55	1.30	44.28	
		20	-	-	-	-	5.38	2.78	1.54	59.29	5.33	3.38	1.53	58.33	5.27	3.96	1.51	57.28	5.24	4.54	1.50	56.52	
	4	15	1.85	1.85	0.40	5.73	2.46	2.46	0.53	9.28	3.06	3.06	0.65	13.45	3.64	3.64	0.78	18.20	4.22	4.22	0.91	23.49	
		17	1.91	1.87	0.41	6.01	2.47	2.47	0.53	9.31	3.06	3.06	0.66	13.50	3.65	3.65	0.78	18.26	4.23	4.23	0.91	23.58	
		19	-	-	-	-	3.55	2.47	0.76	17.38	3.54	3.07	0.76	17.33	3.75	3.67	0.80	19.08	4.24	4.24	0.91	23.67	
		20	-	-	-	-	4.56	2.48	0.98	26.79	4.52	3.08	0.97	26.49	4.48	3.66	0.96	25.96	4.53	4.26	0.97	26.49	
	5	15	1.55	1.55	0.27	2.45	2.15	2.15	0.37	5.08	2.76	2.76	0.47	7.73	3.35	3.35	0.58	10.77	3.93	3.93	0.67	14.05	
		17	1.55	1.54	0.27	2.46	2.16	2.16	0.37	5.10	2.76	2.76	0.48	7.75	3.36	3.36	0.58	10.81	3.94	3.94	0.68	14.10	
		19	-	-	-	-	2.72	2.16	0.47	7.54	2.92	2.78	0.50	8.51	3.36	3.36	0.58	10.86	3.94	3.94	0.68	14.15	
		20	-	-	-	-	3.69	2.16	0.63	12.59	3.68	2.77	0.63	12.63	3.72	3.37	0.64	12.78	4.02	3.96	0.69	14.60	
	6	15	1.26	1.26	0.18	0.95	1.84	1.84	0.26	2.44	2.45	2.45	0.35	4.60	3.04	3.04	0.43	6.62	3.63	3.63	0.52	8.95	
		17	1.26	1.26	0.18	0.95	1.85	1.85	0.27	2.46	2.45	2.45	0.35	4.62	3.05	3.05	0.44	6.64	3.64	3.64	0.52	8.98	
		19	-	-	-	-	1.99	1.86	0.29	2.98	2.46	2.46	0.35	4.65	3.05	3.05	0.44	6.67	3.65	3.65	0.52	9.02	
		20	-	-	-	-	2.78	1.84	0.40	5.69	2.84	2.46	0.41	5.88	3.16	3.07	0.45	7.08	3.65	3.65	0.52	9.04	
	13	3	15	1.55	1.55	0.45	6.91	2.16	2.16	0.62	12.14	2.76	2.76	0.79	18.50	3.35	3.35	0.96	25.87	3.93	3.93	1.12	33.74
			17	1.56	1.55	0.45	6.93	2.16	2.16	0.62	12.19	2.76	2.76	0.79	18.57	3.35	3.35	0.96	25.96	3.93	3.93	1.12	33.86
			19	-	-	-	-	2.73	2.17	0.78	18.11	2.86	2.79	0.82	19.65	3.36	3.36	0.97	26.06	3.94	3.94	1.13	34.00
			20	-	-	-	-	3.70	2.17	1.06	30.44	3.67	2.77	1.05	29.93	3.68	3.36	1.05	30.09	3.96	3.96	1.13	34.29
		4	15	1.24	1.24	0.27	2.52	1.85	1.85	0.40	5.60	2.45	2.45	0.53	9.09	3.05	3.05	0.65	13.18	3.63	3.63	0.78	18.03
			17	1.24	1.24	0.27	2.53	1.85	1.85	0.40	5.63	2.46	2.46	0.53	9.12	3.05	3.05	0.65	13.23	3.64	3.64	0.78	18.10
			19	-	-	-	-	1.97	1.87	0.42	6.25	2.46	2.45	0.53	9.15	3.06	3.06	0.66	13.28	3.65	3.65	0.79	18.17
			20	-	-	-	-	2.82	1.86	0.60	11.53	2.84	2.47	0.61	11.67	3.13	3.08	0.67	13.79	3.65	3.65	0.79	18.21
5		15	0.95	0.95	0.16	0.80	1.54	1.54	0.26	2.48	2.15	2.15	0.37	4.94	2.75	2.75	0.47	7.51	3.34	3.34	0.57	10.47	
		17	0.95	0.95	0.16	0.80	1.54	1.54	0.26	2.49	2.15	2.15	0.37	4.96	2.75	2.75	0.47	7.54	3.34	3.34	0.57	10.51	
		19	-	-	-	-	1.55	1.54	0.27	2.51	2.16	2.16	0.37	4.98	2.76	2.76	0.47	7.57	3.35	3.35	0.57	10.55	
		20	-	-	-	-	1.91	1.54	0.33	4.04	2.24	2.17	0.38	5.31	2.76	2.75	0.47	7.58	3.35	3.35	0.58	10.57	
6		15	0.65	0.65	0.09	0.44	1.26	1.26	0.18	0.93	1.84	1.84	0.26	2.49	2.44	2.44	0.35	4.49	3.04	3.04	0.43	6.51	
		17	0.65	0.65	0.09	0.44	1.26	1.26	0.18	0.93	1.84	1.84	0.26	2.50	2.45	2.45	0.35	4.51	3.04	3.04	0.44	6.53	
		19	-	-	-	-	1.26	1.26	0.18	0.93	1.85	1.85	0.26	2.51	2.45	2.45	0.35	4.53	3.05	3.05	0.44	6.56	
		20	-	-	-	-	1.35	1.27	0.19	1.09	1.85	1.84	0.26	2.52	2.46	2.46	0.35	4.54	3.05	3.05	0.44	6.57	
15		3	15	-	-	-	-	1.55	1.55	0.44	6.68	2.15	2.15	0.61	11.74	2.75	2.75	0.79	18.14	3.33	3.33	0.95	24.97
			17	0.93	0.93	0.27	2.54	1.55	1.55	0.44	6.70	2.15	2.15	0.61	11.78	2.75	2.75	0.79	18.20	3.34	3.34	0.95	25.07
			19	-	-	-	-	1.55	1.54	0.44	6.72	2.16	2.16	0.62	11.83	2.76	2.76	0.79	18.27	3.34	3.34	0.95	25.16
			20	-	-	-	-	1.93	1.55	0.55	9.75	2.20	2.18	0.63	12.18	2.76	2.76	0.79	18.31	3.35	3.35	0.96	25.22
		4	15	0.64	0.64	0.14	0.65	1.23	1.23	0.26	2.54	1.85	1.85	0.40	5.52	2.45	2.45	0.52	8.92	3.04	3.04	0.66	13.08
			17	0.63	0.63	0.14	0.65	1.24	1.24	0.27	2.56	1.85	1.85	0.40	5.55	2.45	2.45	0.53	8.96	3.05	3.05	0.66	13.13
			19	-	-	-	-	1.24	1.24	0.27	2.57	1.86	1.86	0.40	5.57	2.46	2.46	0.53	8.99	3.05	3.05	0.66	13.18
			20	-	-	-	-	1.27	1.27	0.27	2.72	1.86	1.85	0.40	5.58	2.46	2.46	0.53	9.01	3.06	3.06	0.66	13.21
	5	15	0.33	0.33	0.06	0.26	0.95	0.95	0.16	0.78	1.54	1.54	0.27	2.58	2.15	2.15	0.37	4.90	2.74	2.74	0.47	7.43	
		17	0.33	0.33	0.06	0.26	0.95	0.95	0.16	0.78	1.54	1.54	0.27	2.60	2.15	2.15	0.37	4.92	2.75	2.75	0.47	7.46	
		19	-	-	-	-	0.95	0.95	0.16	0.79	1.54	1.54	0.27	2.61	2.15	2.15	0.37	4.94	2.75	2.75	0.47	7.49	
		20	-	-	-	-	0.95	0.95	0.16	0.79	1.55	1.55	0.27	2.62	2.16	2.16	0.37	4.95	2.76	2.76	0.48	7.51	
	6	15	-	-	-	-	0.65	0.65	0.09	0.42	1.25	1.25	0.18	0.93	1.84	1.84	0.26	2.57	2.44	2.44	0.35	4.44	
		17	-	-	-	-	0.65	0.65	0.09	0.42	1.26	1.26	0.18	0.94	1.84	1.84	0.26	2.58	2.44	2.44	0.35	4.46	
		19	-	-	-	-	0.65	0.65	0.09	0.42	1.26	1.26	0.18	0.94	1.84	1.84	0.26	2.60	2.45	2.45	0.35	4.48	
		20	-	-	-	-	0.65	0.65	0.09	0.42	1.26	1.26	0.18	0.95	1.85	1.85	0.27	2.60	2.45	2.45	0.35	4.49	

Cooling capacity

MDVF-800D3E																							
EWT	ΔT	Indoor temp (W.B.)	Indoor temperature (D.B.)																				
			21				23				25				27				29				
			TC	SC	WF	WPD	TC	SC	WF	WPD	TC	SC	WF	WPD	TC	SC	WF	WPD	TC	SC	WF	WPD	
°C	°C	°C	kW	kW	m³/h	kPa	kW	kW	m³/h	kPa	kW	kW	m³/h	kPa	kW	kW	m³/h	kPa	kW	kW	m³/h	kPa	
5	3	15	6.96	5.44	1.99	58.31	6.91	6.23	1.98	57.56	7.04	7.04	2.02	59.50	7.79	7.79	2.23	71.09	8.56	8.56	2.46	83.85	
		17	9.35	5.45	2.69	98.06	9.28	6.25	2.67	96.69	9.20	7.04	2.64	95.27	9.13	7.81	2.62	93.91	9.08	8.58	2.62	93.72	
		19	-	-	-	-	11.83	6.28	3.41	149.21	11.76	7.07	3.40	148.06	11.66	7.84	3.37	145.52	11.58	8.61	3.35	144.64	
		20	-	-	-	-	13.18	6.29	3.80	180.33	13.09	7.08	3.78	178.11	13.00	7.86	3.75	175.94	12.91	8.63	3.72	173.78	
	4	15	6.05	5.02	1.30	27.56	6.07	5.83	1.30	27.72	6.61	6.61	1.42	32.09	7.39	7.39	1.59	39.17	8.16	8.16	1.75	46.30	
		17	8.45	5.04	1.82	49.23	8.38	5.84	1.80	48.47	8.31	6.63	1.78	47.75	8.25	7.41	1.77	47.16	8.32	8.19	1.79	47.85	
		19	-	-	-	-	10.94	5.86	2.35	77.27	10.87	6.66	2.34	76.77	10.79	7.44	2.33	76.15	10.70	8.21	2.31	75.11	
		20	-	-	-	-	12.29	5.87	2.65	94.96	12.20	6.66	2.63	93.73	12.11	7.45	2.61	92.67	12.04	8.23	2.61	92.45	
	5	15	5.15	4.60	0.88	14.14	5.46	5.43	0.94	15.78	6.21	6.21	1.07	19.65	6.98	6.98	1.20	23.88	7.76	7.76	1.34	28.89	
		17	7.51	4.62	1.29	27.06	7.44	5.42	1.28	26.64	7.38	6.21	1.27	26.28	7.40	7.01	1.27	26.37	7.79	7.79	1.34	29.06	
		19	-	-	-	-	10.01	5.45	1.72	44.56	9.93	6.24	1.71	43.94	9.85	7.02	1.69	43.29	9.76	7.79	1.68	42.65	
		20	-	-	-	-	11.36	5.46	1.95	55.59	11.28	6.25	1.94	54.90	11.20	7.04	1.92	54.15	11.11	7.81	1.91	53.39	
	6	15	4.36	4.20	0.62	7.80	5.00	4.99	0.72	9.83	5.80	5.80	0.83	12.71	6.58	6.58	0.94	15.79	7.35	7.35	1.05	18.97	
		17	6.54	4.21	0.94	15.62	6.49	5.01	0.93	15.39	6.48	5.81	0.93	15.36	6.73	6.61	0.97	16.41	7.37	7.37	1.05	19.04	
		19	-	-	-	-	9.05	5.03	1.30	27.14	8.97	5.83	1.28	26.73	8.90	6.61	1.27	26.33	8.83	7.39	1.26	25.99	
		20	-	-	-	-	10.43	5.05	1.50	34.88	10.35	5.85	1.49	34.40	10.26	6.64	1.47	33.92	10.18	7.41	1.46	33.44	
	7	3	15	5.16	4.61	1.49	34.69	5.42	5.42	1.57	37.85	6.20	6.20	1.78	47.20	6.99	6.99	2.01	58.42	7.76	7.76	2.25	70.93
			17	7.53	4.63	2.18	66.80	7.46	5.43	2.15	65.57	7.39	6.22	2.13	64.20	7.36	7.00	2.12	63.71	7.78	7.77	2.26	71.19
			19	-	-	-	-	10.03	5.45	2.92	111.45	9.96	6.25	2.90	110.19	9.86	7.02	2.85	106.82	9.78	7.80	2.82	105.26
			20	-	-	-	-	11.39	5.47	3.32	140.19	11.29	6.25	3.27	136.00	11.21	7.04	3.25	134.70	11.13	7.82	3.25	134.56
4		15	4.34	4.22	0.94	15.52	5.00	5.00	1.07	19.60	5.79	5.79	1.25	25.30	6.59	6.59	1.43	31.88	7.35	7.35	1.58	38.21	
		17	6.57	4.21	1.42	31.71	6.51	5.02	1.41	31.20	6.48	5.81	1.40	30.93	6.68	6.62	1.45	32.66	7.37	7.37	1.59	38.36	
		19	-	-	-	-	9.07	5.04	1.97	55.66	8.99	5.84	1.95	54.84	8.92	6.62	1.93	54.02	8.85	7.40	1.92	53.25	
		20	-	-	-	-	10.42	5.05	2.26	70.79	10.34	5.85	2.24	69.85	10.25	6.63	2.22	68.68	10.16	7.40	2.19	67.29	
5		15	3.78	3.77	0.65	8.25	4.59	4.59	0.79	11.48	5.39	5.39	0.93	15.15	6.17	6.17	1.06	19.09	6.95	6.95	1.20	23.43	
		17	5.55	3.79	0.96	15.94	5.52	4.60	0.95	15.78	5.65	5.42	0.97	16.43	6.19	6.18	1.06	19.17	6.97	6.97	1.20	23.52	
		19	-	-	-	-	8.08	4.63	1.40	30.60	8.01	5.42	1.38	30.12	7.99	6.21	1.44	38.84	7.90	6.99	1.37	29.42	
		20	-	-	-	-	9.42	4.63	1.62	39.69	9.35	5.43	1.61	39.10	9.26	6.22	1.60	38.52	9.18	7.00	1.58	37.94	
6		15	3.35	3.35	0.48	4.83	4.17	4.17	0.60	7.11	4.98	4.98	0.71	9.61	5.77	5.77	0.83	12.36	6.55	6.55	0.94	15.37	
		17	4.49	3.36	0.64	8.06	4.57	4.19	0.66	8.31	5.02	5.00	0.72	9.76	5.78	5.78	0.83	12.41	6.57	6.57	0.94	15.43	
		19	-	-	-	-	7.03	4.20	1.01	17.37	6.97	5.00	1.00	17.10	6.93	5.80	0.99	16.93	7.02	6.60	1.01	17.34	
		20	-	-	-	-	8.41	4.22	1.21	23.77	8.34	5.02	1.20	23.39	8.26	5.81	1.19	23.03	8.19	6.59	1.18	22.62	
9		3	15	3.78	3.77	1.08	19.70	4.59	4.59	1.33	27.99	5.38	5.38	1.55	36.40	6.18	6.18	1.79	46.87	6.95	6.95	2.00	56.86
			17	5.55	3.79	1.59	38.32	5.50	4.59	1.58	37.76	5.56	5.42	1.60	38.48	6.19	6.19	1.79	47.06	6.96	6.96	2.00	57.08
			19	-	-	-	-	8.08	4.62	2.35	75.14	8.01	5.42	2.33	73.98	7.94	6.21	2.30	72.80	7.88	6.99	2.29	71.88
			20	-	-	-	-	9.42	4.63	2.72	97.31	9.34	5.43	2.70	95.91	9.27	6.22	2.68	94.67	9.21	7.01	2.67	94.22
	4	15	3.36	3.36	0.72	9.80	4.18	4.18	0.90	14.19	4.98	4.98	1.08	19.31	5.77	5.77	1.25	25.03	6.55	6.55	1.41	30.82	
		17	4.52	3.37	0.97	16.25	4.55	4.20	0.98	16.47	5.00	5.00	1.08	19.45	5.79	5.79	1.25	25.13	6.56	6.56	1.41	30.94	
		19	-	-	-	-	7.03	4.20	1.51	34.84	6.96	5.00	1.50	34.27	6.91	5.79	1.49	33.85	6.94	6.59	1.50	34.15	
		20	-	-	-	-	8.39	4.21	1.81	47.49	8.32	5.01	1.79	46.75	8.26	5.81	1.79	46.67	8.19	6.60	1.78	46.00	
	5	15	2.94	2.94	0.51	5.31	3.76	3.76	0.65	8.07	4.57	4.57	0.79	11.24	5.37	5.37	0.93	14.86	6.15	6.15	1.06	18.70	
		17	3.47	2.95	0.60	7.01	3.85	3.79	0.66	8.38	4.58	4.58	0.79	11.28	5.38	5.38	0.93	14.92	6.16	6.16	1.06	18.77	
		19	-	-	-	-	5.96	3.79	1.03	17.70	5.91	4.59	1.02	17.47	5.94	5.40	1.02	17.62	6.28	6.19	1.08	19.39	
		20	-	-	-	-	7.33	3.80	1.26	25.32	7.26	4.60	1.25	24.90	7.20	5.40	1.24	24.53	7.16	6.18	1.23	24.34	
	6	15	2.53	2.53	0.36	2.51	3.34	3.34	0.48	4.80	4.16	4.16	0.60	6.97	4.96	4.96	0.71	9.41	5.75	5.75	0.82	12.10	
		17	2.65	2.55	0.38	2.85	3.35	3.34	0.48	4.82	4.17	4.17	0.60	7.00	4.97	4.97	0.71	9.45	5.76	5.76	0.83	12.15	
		19	-	-	-	-	4.85	3.36	0.70	9.04	4.87	4.18	0.70	9.11	5.19	5.00	0.74	10.15	5.77	5.77	0.83	12.20	
		20	-	-	-	-	6.21	3.38	0.89	13.81	6.15	4.19	0.88	13.60	6.13	4.99	0.88	13.50	6.25	5.80	0.90	13.98	

Continued:

MDVF-800D3E																							
EWT	ΔT	Indoor temp (W.B.)	Indoor temperature (D.B.)																				
			21				23				25				27				29				
			TC	SC	WF	WPD	TC	SC	WF	WPD	TC	SC	WF	WPD	TC	SC	WF	WPD	TC	SC	WF	WPD	
°C	°C	°C	kW	kW	m³/h	kPa	kW	kW	m³/h	kPa	kW	kW	m³/h	kPa	kW	kW	m³/h	kPa	kW	kW	m³/h	kPa	
11	3	15	2.95	2.95	0.84	12.53	3.76	3.76	1.07	19.07	4.57	4.57	1.30	26.70	5.36	5.36	1.54	35.47	6.14	6.14	1.75	44.63	
		17	3.46	2.95	0.99	16.51	3.80	3.79	1.08	19.36	4.58	4.58	1.31	26.82	5.37	5.37	1.54	35.60	6.15	6.15	1.76	44.80	
		19	-	-	-	-	5.97	3.79	1.71	42.88	5.92	4.59	1.70	42.40	5.91	5.39	1.70	42.22	6.19	6.19	1.77	45.32	
		20	-	-	-	-	7.32	3.79	2.09	60.73	7.25	4.60	2.07	59.70	7.18	5.39	2.06	58.80	7.13	6.18	2.04	58.08	
	4	15	2.53	2.53	0.54	5.89	3.35	3.35	0.72	9.51	4.16	4.16	0.89	13.77	4.95	4.95	1.06	18.60	5.74	5.74	1.23	24.00	
		17	2.61	2.57	0.56	6.22	3.36	3.36	0.72	9.55	4.17	4.17	0.89	13.82	4.97	4.97	1.06	18.68	5.75	5.75	1.23	24.09	
		19	-	-	-	-	4.85	3.36	1.04	17.93	4.84	4.18	1.04	17.89	5.11	5.00	1.09	19.61	5.77	5.76	1.24	24.19	
		20	-	-	-	-	6.21	3.38	1.33	27.50	6.15	4.19	1.32	27.04	6.11	4.98	1.31	26.72	6.17	5.79	1.32	27.16	
	5	15	2.11	2.11	0.36	2.59	2.94	2.94	0.51	5.22	3.75	3.75	0.65	7.91	4.55	4.55	0.78	11.01	5.34	5.34	0.92	14.35	
		17	2.12	2.10	0.36	2.60	2.94	2.94	0.51	5.24	3.76	3.76	0.65	7.94	4.56	4.56	0.79	11.05	5.35	5.35	0.92	14.40	
		19	-	-	-	-	3.73	2.95	0.64	7.84	3.99	3.80	0.69	8.79	4.58	4.57	0.79	11.11	5.36	5.36	0.92	14.47	
		20	-	-	-	-	5.04	2.95	0.86	12.98	5.01	3.76	0.86	12.84	5.08	4.59	0.87	13.19	5.49	5.39	0.95	15.17	
	6	15	1.72	1.72	0.25	0.97	2.52	2.52	0.36	2.58	3.34	3.34	0.48	4.73	4.14	4.14	0.59	6.77	4.94	4.94	0.71	9.14	
		17	1.72	1.72	0.25	0.97	2.52	2.52	0.36	2.60	3.34	3.34	0.48	4.74	4.15	4.15	0.59	6.80	4.95	4.95	0.71	9.18	
		19	-	-	-	-	2.74	2.56	0.39	3.19	3.36	3.36	0.48	4.80	4.16	4.16	0.59	6.83	4.96	4.96	0.71	9.22	
		20	-	-	-	-	3.83	2.53	0.55	5.94	3.91	3.36	0.56	6.13	4.33	4.18	0.62	7.31	4.96	4.96	0.71	9.24	
	13	3	15	2.11	2.11	0.61	7.09	2.94	2.94	0.84	12.43	3.75	3.75	1.08	18.91	4.54	4.54	1.31	26.36	5.33	5.33	1.52	34.44
			17	2.12	2.12	0.61	7.11	2.94	2.94	0.85	12.47	3.76	3.76	1.08	18.98	4.55	4.55	1.31	26.43	5.34	5.34	1.53	34.58
			19	-	-	-	-	3.72	2.95	1.07	18.68	3.89	3.80	1.12	20.18	4.56	4.56	1.31	26.50	5.35	5.35	1.53	34.72
			20	-	-	-	-	5.04	2.95	1.44	31.24	5.00	3.76	1.43	30.77	5.01	4.58	1.43	30.93	5.39	5.38	1.54	35.09
		4	15	1.69	1.69	0.36	2.65	2.51	2.51	0.54	5.75	3.33	3.33	0.71	9.30	4.14	4.14	0.89	13.46	4.94	4.94	1.06	18.41
			17	1.69	1.69	0.36	2.67	2.52	2.52	0.54	5.77	3.34	3.34	0.72	9.33	4.15	4.15	0.89	13.52	4.95	4.95	1.07	18.48
			19	-	-	-	-	2.70	2.56	0.58	6.48	3.35	3.34	0.72	9.37	4.16	4.16	0.89	13.57	4.96	4.96	1.07	18.56
			20	-	-	-	-	3.86	2.53	0.83	11.92	3.88	3.36	0.83	12.07	4.28	4.20	0.92	14.38	4.97	4.96	1.07	18.60
5		15	1.29	1.29	0.22	0.81	2.10	2.10	0.36	2.61	2.92	2.92	0.50	5.06	3.73	3.73	0.64	7.68	4.53	4.53	0.78	10.68	
		17	1.29	1.29	0.22	0.81	2.10	2.10	0.36	2.63	2.93	2.93	0.50	5.08	3.74	3.74	0.64	7.71	4.54	4.54	0.78	10.73	
		19	-	-	-	-	2.11	2.10	0.36	2.66	2.94	2.94	0.50	5.11	3.75	3.75	0.64	7.74	4.55	4.55	0.78	10.77	
		20	-	-	-	-	2.64	2.11	0.45	4.26	3.07	2.97	0.53	5.50	3.76	3.74	0.64	7.75	4.56	4.56	0.78	10.80	
6		15	0.88	0.88	0.13	0.44	1.71	1.71	0.24	0.95	2.51	2.51	0.36	2.61	3.32	3.32	0.48	4.60	4.13	4.13	0.59	6.64	
		17	0.88	0.88	0.13	0.44	1.71	1.71	0.24	0.96	2.51	2.51	0.36	2.63	3.33	3.33	0.48	4.62	4.14	4.14	0.59	6.67	
		19	-	-	-	-	1.72	1.71	0.25	0.96	2.52	2.52	0.36	2.64	3.34	3.34	0.48	4.64	4.15	4.15	0.59	6.70	
		20	-	-	-	-	1.86	1.74	0.27	1.16	2.52	2.51	0.36	2.65	3.34	3.34	0.48	4.65	4.15	4.15	0.59	6.72	
15		3	15	-	-	-	-	2.10	2.10	0.60	6.84	2.92	2.92	0.83	12.00	3.73	3.73	1.07	18.52	4.52	4.52	1.29	25.48
			17	-	-	-	-	2.11	2.11	0.60	6.87	2.93	2.93	0.84	12.04	3.74	3.74	1.08	18.59	4.53	4.53	1.29	25.58
			19	-	-	-	-	2.11	2.09	0.60	6.89	2.94	2.94	0.84	12.10	3.75	3.75	1.08	18.67	4.54	4.54	1.30	25.69
			20	-	-	-	-	2.64	2.12	0.75	10.10	2.99	2.98	0.85	12.50	3.75	3.75	1.08	18.71	4.54	4.54	1.30	25.75
		4	15	0.87	0.87	0.19	0.65	1.68	1.68	0.36	2.67	2.51	2.51	0.54	5.65	3.33	3.33	0.71	9.16	4.13	4.13	0.89	13.34
			17	-	-	-	-	1.69	1.69	0.36	2.68	2.52	2.52	0.54	5.68	3.33	3.33	0.72	9.21	4.14	4.14	0.89	13.39
			19	-	-	-	-	1.69	1.69	0.36	2.70	2.52	2.52	0.54	5.70	3.34	3.34	0.72	9.26	4.15	4.15	0.89	13.45
			20	-	-	-	-	1.73	1.73	0.37	2.87	2.53	2.52	0.54	5.71	3.35	3.35	0.72	9.29	4.15	4.15	0.89	13.48
	5	15	0.45	0.45	0.08	0.26	1.29	1.29	0.22	0.79	2.10	2.10	0.36	2.70	2.92	2.92	0.50	5.01	3.72	3.72	0.64	7.58	
		17	0.45	0.45	0.08	0.26	1.29	1.29	0.22	0.80	2.10	2.10	0.36	2.71	2.92	2.92	0.50	5.03	3.73	3.73	0.64	7.61	
		19	-	-	-	-	1.30	1.30	0.22	0.80	2.11	2.11	0.36	2.73	2.93	2.93	0.51	5.05	3.74	3.74	0.64	7.64	
		20	-	-	-	-	1.30	1.28	0.22	0.80	2.11	2.11	0.36	2.74	2.93	2.93	0.51	5.06	3.74	3.74	0.65	7.66	
	6	15	-	-	-	-	0.87	0.87	0.13	0.42	1.70	1.70	0.24	0.97	2.50	2.50	0.36	2.68	3.31	3.31	0.48	4.54	
		17	-	-	-	-	0.88	0.88	0.13	0.42	1.70	1.70	0.24	0.97	2.50	2.50	0.36	2.69	3.32	3.32	0.48	4.55	
		19	-	-	-	-	0.88	0.88	0.13	0.42	1.71	1.71	0.25	0.98	2.51	2.51	0.36	2.71	3.33	3.33	0.48	4.57	
		20	-	-	-	-	0.88	0.88	0.13	0.42	1.71	1.71	0.25	0.98	2.51	2.51	0.36	2.72	3.33	3.33	0.48	4.59	

Cooling capacity

MDVF-1000D3E																							
EWT	ΔT	Indoor temp (W.B.)	Indoor temperature (D.B.)																				
			21				23				25				27				29				
°C	°C	°C	TC	SC	WF	WPD	TC	SC	WF	WPD	TC	SC	WF	WPD	TC	SC	WF	WPD	TC	SC	WF	WPD	
			kW	kW	m³/h	kPa	kW	kW	m³/h	kPa	kW	kW	m³/h	kPa	kW	kW	m³/h	kPa	kW	kW	m³/h	kPa	
5	3	15	7.76	6.09	2.23	41.73	7.69	7.00	2.21	41.07	7.89	7.88	2.26	42.72	8.78	8.78	2.51	51.45	9.66	9.66	2.77	60.84	
		17	10.44	6.10	2.99	69.74	10.37	7.01	2.97	68.90	10.29	7.91	2.95	68.05	10.23	8.80	2.94	67.72	10.16	9.68	2.93	67.38	
		19	-	-	-	-	13.28	7.04	3.85	108.19	13.19	7.94	3.82	106.97	13.11	8.83	3.80	105.74	13.02	9.71	3.77	104.51	
		20	-	-	-	-	14.79	7.04	4.26	129.54	14.70	7.94	4.24	128.46	14.62	8.84	4.24	128.45	14.53	9.73	4.22	127.11	
	4	15	6.68	5.60	1.44	19.53	6.70	6.52	1.44	19.64	7.41	7.41	1.59	23.12	8.30	8.30	1.78	28.15	9.18	9.18	1.97	33.54	
		17	9.37	5.61	2.01	34.75	9.31	6.52	2.00	34.33	9.23	7.42	1.98	33.86	9.15	8.31	1.96	33.36	9.26	9.21	1.99	34.07	
		19	-	-	-	-	12.21	6.55	2.63	55.36	12.13	7.45	2.61	54.72	12.04	8.34	2.59	54.08	11.96	9.23	2.58	53.45	
		20	-	-	-	-	13.72	6.55	2.95	67.66	13.63	7.45	2.93	66.88	13.54	8.35	2.91	66.12	13.46	9.24	2.89	65.35	
	5	15	5.56	5.10	0.95	9.60	6.02	6.01	1.03	11.00	6.93	6.93	1.19	13.98	7.83	7.83	1.35	17.39	8.72	8.72	1.50	20.89	
		17	8.29	5.13	1.43	19.17	8.22	6.04	1.42	18.89	8.15	6.95	1.40	18.60	8.16	7.85	1.41	18.65	8.73	8.72	1.50	20.87	
		19	-	-	-	-	11.12	6.06	1.92	31.84	11.05	6.97	1.90	31.46	10.97	7.87	1.89	31.10	10.89	8.75	1.88	30.68	
		20	-	-	-	-	12.65	6.07	2.18	39.84	12.57	6.98	2.17	39.38	12.48	7.88	2.15	38.92	12.40	8.77	2.14	38.47	
	6	15	4.64	4.61	0.66	5.15	5.53	5.53	0.79	6.97	6.45	6.45	0.92	9.04	7.35	7.35	1.05	11.30	8.24	8.24	1.18	13.79	
		17	7.12	4.63	1.02	10.70	7.05	5.55	1.01	10.52	7.03	6.46	1.01	10.46	7.40	7.37	1.06	11.42	8.26	8.26	1.19	13.84	
		19	-	-	-	-	9.97	5.57	1.43	19.00	9.90	6.48	1.42	18.76	9.81	7.38	1.40	18.49	9.73	8.26	1.39	18.22	
		20	-	-	-	-	11.51	5.58	1.65	24.33	11.43	6.49	1.63	24.04	11.35	7.39	1.62	23.76	11.27	8.28	1.61	23.46	
	7	3	15	5.67	5.15	1.63	23.85	6.07	6.05	1.74	26.80	6.98	6.98	2.02	34.63	7.86	7.86	2.26	42.09	8.76	8.76	2.53	51.25
			17	8.38	5.17	2.41	46.99	8.31	6.08	2.39	46.36	8.23	6.98	2.37	45.60	8.20	7.88	2.35	45.24	8.77	8.77	2.53	51.35
			19	-	-	-	-	11.20	6.10	3.23	78.36	11.12	7.01	3.20	77.40	11.05	7.90	3.18	76.47	10.97	8.79	3.16	75.49
			20	-	-	-	-	12.76	6.12	3.71	99.96	12.67	7.03	3.68	98.81	12.59	7.92	3.66	97.63	12.48	8.80	3.60	94.82
		4	15	4.74	4.69	1.02	10.67	5.59	5.59	1.21	14.24	6.49	6.49	1.40	18.23	7.39	7.39	1.59	22.80	8.28	8.28	1.78	27.74
			17	7.24	4.68	1.56	22.00	7.17	5.60	1.54	21.61	7.12	6.50	1.53	21.36	7.43	7.42	1.60	22.98	8.29	8.29	1.78	27.83
			19	-	-	-	-	10.07	5.61	2.17	39.00	10.00	6.52	2.15	38.54	9.93	7.42	2.14	38.03	9.84	8.31	2.12	37.45
			20	-	-	-	-	11.63	5.63	2.52	50.59	11.55	6.54	2.50	49.99	11.47	7.44	2.48	49.39	11.39	8.33	2.47	48.80
5		15	4.17	4.17	0.72	5.82	5.10	5.10	0.88	8.19	6.02	6.02	1.03	10.85	6.92	6.92	1.19	13.78	7.81	7.81	1.35	17.04	
		17	6.05	4.19	1.04	10.94	5.99	5.11	1.03	10.77	6.17	6.04	1.06	11.33	6.93	6.93	1.19	13.83	7.83	7.83	1.35	17.10	
		19	-	-	-	-	8.92	5.13	1.53	21.32	8.84	6.04	1.52	21.02	8.45	6.65	1.52	46.00	8.70	7.84	1.50	20.44	
		20	-	-	-	-	10.47	5.15	1.81	28.38	10.40	6.06	1.80	28.03	10.33	6.97	1.78	27.69	10.24	7.86	1.77	27.29	
6		15	3.68	3.68	0.53	3.14	4.60	4.60	0.66	5.01	5.53	5.53	0.79	6.85	6.44	6.44	0.92	8.88	7.34	7.34	1.05	11.09	
		17	4.76	3.67	0.68	5.30	4.86	4.62	0.70	5.50	5.54	5.53	0.79	6.87	6.45	6.45	0.92	8.91	7.35	7.35	1.05	11.13	
		19	-	-	-	-	7.70	4.65	1.10	12.04	7.62	5.56	1.09	11.83	7.56	6.46	1.08	11.68	7.68	7.37	1.10	11.99	
		20	-	-	-	-	9.25	4.66	1.33	16.52	9.18	5.57	1.32	16.29	9.10	6.48	1.30	16.04	9.02	7.37	1.29	15.80	
9		3	15	4.22	4.22	1.21	14.16	5.14	5.14	1.48	19.87	6.06	6.06	1.75	26.74	6.95	6.95	2.00	33.49	7.85	7.85	2.27	41.95
			17	6.18	4.24	1.79	27.66	6.12	5.16	1.77	27.16	6.19	6.09	1.79	27.69	6.97	6.97	2.00	33.60	7.87	7.87	2.28	42.09
			19	-	-	-	-	9.00	5.16	2.59	52.59	8.93	6.08	2.57	51.90	8.85	6.98	2.55	51.11	8.80	7.88	2.55	51.12
			20	-	-	-	-	10.53	5.17	3.04	69.42	10.46	6.09	3.01	68.54	10.38	6.99	2.99	67.67	10.31	7.88	2.97	66.81
		4	15	3.73	3.73	0.80	6.97	4.66	4.66	1.00	10.18	5.58	5.58	1.21	13.95	6.49	6.49	1.40	18.02	7.38	7.38	1.59	22.51
			17	4.92	3.74	1.06	11.17	4.96	4.68	1.07	11.32	5.59	5.58	1.21	13.98	6.50	6.50	1.40	18.08	7.39	7.39	1.60	22.59
			19	-	-	-	-	7.82	4.69	1.69	25.03	7.75	5.61	1.68	24.62	7.68	6.51	1.66	24.23	7.71	7.42	1.67	24.43
			20	-	-	-	-	9.34	4.69	2.01	33.72	9.26	5.61	2.00	33.27	9.19	6.51	1.98	32.79	9.10	7.41	1.96	32.26
	5	15	3.23	3.23	0.56	3.59	4.17	4.17	0.72	5.73	5.10	5.10	0.88	8.06	6.01	6.01	1.03	10.67	6.91	6.91	1.19	13.54	
		17	3.65	3.24	0.63	4.56	4.19	4.19	0.72	5.77	5.11	5.11	0.88	8.09	6.02	6.02	1.04	10.70	6.92	6.92	1.19	13.59	
		19	-	-	-	-	6.54	4.20	1.13	12.33	6.48	5.12	1.11	12.12	6.50	6.03	1.12	12.20	6.96	6.94	1.20	13.73	
		20	-	-	-	-	8.10	4.21	1.39	17.81	8.03	5.13	1.38	17.53	7.94	6.04	1.37	17.23	7.90	6.94	1.36	17.05	
	6	15	2.79	2.79	0.40	1.54	3.67	3.67	0.53	3.20	4.61	4.61	0.66	4.96	5.53	5.53	0.79	6.75	6.43	6.43	0.92	8.74	
		17	2.85	2.80	0.41	1.65	3.68	3.68	0.53	3.21	4.62	4.62	0.66	4.97	5.54	5.54	0.79	6.77	6.45	6.45	0.92	8.77	
		19	-	-	-	-	5.20	3.70	0.75	6.07	5.21	4.63	0.75	6.10	5.64	5.57	0.81	6.97	6.46	6.46	0.93	8.80	
		20	-	-	-	-	6.79	3.72	0.97	9.56	6.71	4.64	0.96	9.38	6.66	5.55	0.96	9.27	6.81	6.48	0.98	9.63	

Continued:

MDVF-1000D3E																							
EWT	ΔT	Indoor temp (W.B.)	Indoor temperature (D.B.)																				
			21				23				25				27				29				
			TC	SC	WF	WPD	TC	SC	WF	WPD	TC	SC	WF	WPD	TC	SC	WF	WPD	TC	SC	WF	WPD	
°C	°C	°C	kW	kW	m³/h	kPa	kW	kW	m³/h	kPa	kW	kW	m³/h	kPa	kW	kW	m³/h	kPa	kW	kW	m³/h	kPa	
11	3	15	3.29	3.29	0.94	8.97	4.23	4.23	1.21	13.95	5.13	5.13	1.46	19.28	6.04	6.04	1.72	25.56	6.93	6.93	1.98	32.49	
		17	3.78	3.29	1.08	11.37	4.23	4.21	1.21	13.99	5.14	5.14	1.47	19.35	6.05	6.05	1.73	25.65	6.94	6.94	1.98	32.59	
		19	-	-	-	-	6.63	4.23	1.89	30.09	6.56	5.15	1.87	29.51	6.54	6.06	1.87	29.32	6.96	6.94	1.99	32.70	
		20	-	-	-	-	8.17	4.24	2.33	43.29	8.11	5.16	2.32	42.83	8.05	6.07	2.32	42.71	7.98	6.97	2.30	42.08	
	4	15	2.79	2.79	0.60	4.15	3.73	3.73	0.80	6.81	4.66	4.66	1.00	9.92	5.57	5.57	1.19	13.48	6.46	6.46	1.38	17.43	
		17	2.81	2.80	0.60	4.21	3.74	3.74	0.80	6.83	4.67	4.67	1.00	9.96	5.58	5.58	1.19	13.52	6.48	6.48	1.39	17.49	
		19	-	-	-	-	5.33	3.75	1.14	12.48	5.31	4.67	1.14	12.40	5.65	5.61	1.21	13.82	6.49	6.49	1.39	17.55	
		20	-	-	-	-	6.88	3.76	1.47	19.41	6.81	4.68	1.46	19.05	6.75	5.59	1.45	18.76	6.81	6.50	1.46	19.08	
	5	15	2.33	2.33	0.40	1.60	3.24	3.24	0.56	3.65	4.18	4.18	0.72	5.66	5.10	5.10	0.88	7.94	6.00	6.00	1.03	10.50	
		17	2.34	2.33	0.40	1.61	3.25	3.25	0.56	3.66	4.19	4.19	0.72	5.68	5.11	5.11	0.88	7.97	6.01	6.01	1.04	10.53	
		19	-	-	-	-	3.98	3.26	0.69	5.21	4.31	4.21	0.74	5.97	5.12	5.11	0.88	7.99	6.03	6.03	1.04	10.57	
		20	-	-	-	-	5.53	3.28	0.95	9.13	5.48	4.20	0.94	8.97	5.55	5.13	0.96	9.18	6.07	6.05	1.04	10.69	
	6	15	1.90	1.90	0.27	0.72	2.78	2.78	0.40	1.60	3.68	3.68	0.53	3.26	4.61	4.61	0.66	4.89	5.52	5.52	0.79	6.59	
		17	1.90	1.90	0.27	0.72	2.79	2.79	0.40	1.61	3.69	3.69	0.53	3.28	4.62	4.62	0.66	4.91	5.53	5.53	0.79	6.61	
		19	-	-	-	-	2.92	2.80	0.42	1.83	3.70	3.69	0.53	3.29	4.63	4.63	0.66	4.93	5.54	5.54	0.79	6.64	
		20	-	-	-	-	4.06	2.76	0.58	3.93	4.13	3.71	0.59	4.05	4.69	4.65	0.67	5.04	5.55	5.55	0.79	6.65	
	13	3	15	2.35	2.35	0.67	5.05	3.29	3.29	0.94	8.95	4.20	4.20	1.20	13.46	5.12	5.12	1.47	19.20	6.02	6.02	1.73	25.41
			17	2.35	2.35	0.68	5.06	3.29	3.29	0.95	8.98	4.21	4.21	1.20	13.51	5.13	5.13	1.48	19.26	6.03	6.03	1.73	25.50
			19	-	-	-	-	4.05	3.28	1.16	12.64	4.29	4.24	1.22	13.93	5.14	5.14	1.48	19.33	6.05	6.05	1.74	25.59
			20	-	-	-	-	5.63	3.31	1.62	22.57	5.56	4.23	1.60	22.12	5.57	5.15	1.60	22.16	6.05	6.04	1.74	25.64
		4	15	1.87	1.87	0.40	1.65	2.80	2.80	0.60	4.14	3.72	3.72	0.80	6.68	4.64	4.64	1.00	9.74	5.55	5.55	1.19	13.22
			17	1.87	1.87	0.40	1.66	2.80	2.80	0.60	4.16	3.73	3.73	0.80	6.70	4.65	4.65	1.00	9.77	5.56	5.56	1.19	13.27
			19	-	-	-	-	2.90	2.83	0.62	4.41	3.74	3.73	0.80	6.72	4.66	4.66	1.00	9.81	5.57	5.57	1.19	13.32
			20	-	-	-	-	4.19	2.81	0.90	8.16	4.21	3.74	0.90	8.24	4.71	4.69	1.01	9.96	5.58	5.58	1.20	13.34
5		15	1.43	1.43	0.25	0.62	2.32	2.32	0.40	1.62	3.24	3.24	0.56	3.59	4.17	4.17	0.72	5.52	5.08	5.08	0.87	7.73	
		17	1.43	1.43	0.25	0.62	2.32	2.32	0.40	1.63	3.24	3.24	0.56	3.60	4.18	4.18	0.72	5.54	5.09	5.09	0.87	7.76	
		19	-	-	-	-	2.33	2.31	0.40	1.64	3.25	3.25	0.56	3.62	4.19	4.19	0.72	5.56	5.10	5.10	0.88	7.79	
		20	-	-	-	-	2.73	2.31	0.47	2.50	3.29	3.28	0.56	3.69	4.19	4.19	0.72	5.57	5.11	5.11	0.88	7.80	
6		15	0.97	0.97	0.14	0.35	1.90	1.90	0.27	0.68	2.77	2.77	0.40	1.64	3.68	3.68	0.53	3.25	4.61	4.61	0.66	4.78	
		17	0.97	0.97	0.14	0.35	1.90	1.90	0.27	0.68	2.78	2.78	0.40	1.64	3.69	3.69	0.53	3.26	4.62	4.62	0.66	4.80	
		19	-	-	-	-	1.90	1.90	0.27	0.69	2.78	2.78	0.40	1.65	3.70	3.70	0.53	3.27	4.63	4.63	0.66	4.82	
		20	-	-	-	-	1.99	1.92	0.28	0.73	2.79	2.78	0.40	1.66	3.70	3.70	0.53	3.28	4.63	4.63	0.66	4.83	
15		3	15	1.40	1.40	0.40	1.66	2.34	2.34	0.67	4.89	3.28	3.28	0.93	8.67	4.19	4.19	1.20	13.25	5.11	5.11	1.47	18.85
			17	1.40	1.40	0.40	1.67	2.35	2.35	0.67	4.91	3.28	3.28	0.94	8.69	4.20	4.20	1.20	13.29	5.12	5.12	1.47	18.91
			19	-	-	-	-	2.35	2.34	0.67	4.92	3.29	3.29	0.94	8.73	4.21	4.21	1.20	13.34	5.13	5.13	1.47	18.98
			20	-	-	-	-	2.85	2.35	0.81	6.84	3.31	3.30	0.94	8.81	4.22	4.22	1.20	13.37	5.13	5.13	1.48	19.01
		4	15	0.96	0.96	0.21	0.51	1.86	1.86	0.40	1.68	2.80	2.80	0.60	4.04	3.72	3.72	0.80	6.58	4.65	4.65	1.00	9.70
			17	0.96	0.96	0.21	0.51	1.86	1.86	0.40	1.68	2.80	2.80	0.60	4.06	3.73	3.73	0.80	6.61	4.66	4.66	1.00	9.74
			19	-	-	-	-	1.87	1.87	0.40	1.69	2.81	2.81	0.60	4.07	3.74	3.74	0.80	6.63	4.67	4.67	1.01	9.77
			20	-	-	-	-	1.88	1.86	0.40	1.73	2.81	2.81	0.60	4.08	3.74	3.74	0.80	6.64	4.67	4.67	1.01	9.79
	5	15	0.50	0.50	0.09	0.21	1.44	1.44	0.25	0.60	2.32	2.32	0.40	1.71	3.25	3.25	0.56	3.59	4.17	4.17	0.72	5.48	
		17	0.50	0.50	0.09	0.21	1.44	1.44	0.25	0.60	2.33	2.33	0.40	1.72	3.25	3.25	0.56	3.60	4.18	4.18	0.72	5.50	
		19	-	-	-	-	1.44	1.44	0.25	0.60	2.33	2.33	0.40	1.73	3.26	3.26	0.56	3.61	4.19	4.19	0.72	5.52	
		20	-	-	-	-	1.44	1.43	0.25	0.60	2.33	2.33	0.40	1.74	3.27	3.27	0.56	3.62	4.19	4.19	0.72	5.53	
	6	15	-	-	-	-	0.98	0.98	0.14	0.33	1.90	1.90	0.27	0.67	2.77	2.77	0.40	1.71	3.69	3.69	0.53	3.25	
		17	-	-	-	-	0.98	0.98	0.14	0.33	1.90	1.90	0.27	0.67	2.78	2.78	0.40	1.72	3.70	3.70	0.53	3.26	
		19	-	-	-	-	0.98	0.98	0.14	0.33	1.91	1.91	0.27	0.67	2.78	2.78	0.40	1.73	3.71	3.71	0.53	3.27	
		20	-	-	-	-	0.98	0.98	0.14	0.33	1.91	1.91	0.27	0.67	2.79	2.79	0.40	1.73	3.71	3.71	0.53	3.28	

Cooling capacity

MDVF-1200D3E																							
EWT	ΔT	Indoor temp (W.B.)	Indoor temperature (D.B.)																				
			21				23				25				27				29				
			TC	SC	WF	WPD	TC	SC	WF	WPD	TC	SC	WF	WPD	TC	SC	WF	WPD	TC	SC	WF	WPD	
°C	°C	°C	kW	kW	m ³ /h	kPa	kW	kW	m ³ /h	kPa	kW	kW	m ³ /h	kPa	kW	kW	m ³ /h	kPa	kW	kW	m ³ /h	kPa	
5	3	15	9.51	7.47	2.72	43.52	9.42	8.58	2.70	42.83	9.70	9.68	2.78	45.35	10.78	10.78	3.09	54.25	11.87	11.87	3.43	65.07	
		17	12.84	7.50	3.71	74.62	12.75	8.61	3.68	73.73	12.66	9.72	3.66	72.87	12.54	10.80	3.60	70.72	12.45	11.88	3.57	69.83	
		19	-	-	-	-	16.30	8.64	4.72	113.97	16.19	9.75	4.69	112.63	16.09	10.84	4.66	111.40	15.98	11.93	4.62	109.66	
		20	-	-	-	-	18.17	8.65	5.26	137.70	18.04	9.75	5.20	134.85	17.92	10.85	5.17	133.38	17.82	11.93	5.13	131.94	
	4	15	8.19	6.87	1.76	20.50	8.23	8.00	1.77	20.66	9.09	9.09	1.95	24.34	10.19	10.19	2.19	29.65	11.28	11.28	2.42	35.34	
		17	11.50	6.88	2.47	36.54	11.42	8.00	2.45	36.09	11.33	9.11	2.43	35.61	11.23	10.21	2.41	35.09	11.38	11.31	2.44	35.92	
		19	-	-	-	-	14.99	8.04	3.24	58.63	14.89	9.15	3.22	57.95	14.80	10.25	3.20	57.29	14.70	11.34	3.17	56.64	
		20	-	-	-	-	16.84	8.04	3.62	71.25	16.74	9.15	3.60	70.44	16.63	10.25	3.57	69.65	16.52	11.34	3.55	68.86	
	5	15	6.82	6.25	1.17	10.07	7.39	7.38	1.27	11.57	8.52	8.52	1.47	14.86	9.62	9.62	1.66	18.30	10.69	10.69	1.83	21.80	
		17	10.17	6.29	1.75	20.13	10.08	7.42	1.74	19.85	9.99	8.53	1.72	19.54	10.02	9.64	1.73	19.63	10.71	10.71	1.84	21.87	
		19	-	-	-	-	13.64	7.44	2.35	33.48	13.55	8.56	2.34	33.08	13.46	9.66	2.32	32.70	13.36	10.75	2.30	32.27	
		20	-	-	-	-	15.50	7.44	2.66	41.47	15.40	8.56	2.64	40.99	15.32	9.67	2.64	40.86	15.22	10.76	2.63	40.49	
6	15	5.70	5.65	0.82	5.43	6.79	6.79	0.97	7.32	7.91	7.91	1.13	9.51	9.03	9.03	1.30	11.94	10.12	10.12	1.45	14.52		
	17	8.73	5.68	1.25	11.23	8.64	6.81	1.24	11.04	8.62	7.93	1.23	10.99	9.09	9.06	1.30	12.08	10.14	10.14	1.46	14.57		
	19	-	-	-	-	12.23	6.83	1.75	19.96	12.14	7.95	1.74	19.72	12.04	9.06	1.72	19.45	11.94	10.15	1.71	19.17		
	20	-	-	-	-	14.12	6.85	2.02	25.58	14.02	7.97	2.01	25.28	13.93	9.07	1.99	24.98	13.83	10.17	1.98	24.68		
7	3	15	6.96	6.32	2.00	25.06	7.46	7.44	2.16	28.65	8.57	8.57	2.48	36.47	9.66	9.66	2.78	44.37	10.75	10.75	3.09	53.48	
		17	10.28	6.34	2.95	49.46	10.20	7.47	2.93	48.81	10.10	8.58	2.90	47.99	10.06	9.68	2.89	47.64	10.77	10.77	3.10	53.65	
		19	-	-	-	-	13.78	7.50	4.00	83.98	13.69	8.62	3.97	82.97	13.57	9.70	3.91	80.62	13.47	10.79	3.88	79.63	
		20	-	-	-	-	15.63	7.50	4.51	103.63	15.53	8.61	4.48	102.42	15.45	9.73	4.48	102.38	15.36	10.82	4.46	101.72	
	4	15	5.82	5.75	1.25	11.24	6.87	6.87	1.48	14.99	7.97	7.97	1.71	19.19	9.08	9.08	1.95	24.01	10.18	10.18	2.20	29.57	
		17	8.88	5.74	1.91	23.12	8.79	6.87	1.89	22.73	8.74	7.98	1.88	22.47	9.12	9.11	1.96	24.21	10.20	10.20	2.21	29.67	
		19	-	-	-	-	12.39	6.90	2.68	41.61	12.31	8.02	2.66	41.12	12.22	9.13	2.64	40.59	12.08	10.20	2.60	39.41	
		20	-	-	-	-	14.27	6.91	3.09	53.26	14.17	8.03	3.07	52.62	14.08	9.14	3.05	51.99	13.98	10.23	3.03	51.38	
	5	15	5.12	5.11	0.88	6.12	6.26	6.26	1.08	8.61	7.39	7.39	1.27	11.42	8.50	8.50	1.46	14.52	9.59	9.59	1.65	17.86	
		17	7.41	5.14	1.27	11.48	7.35	6.27	1.26	11.31	7.58	7.41	1.30	11.93	8.51	8.51	1.46	14.57	9.61	9.61	1.65	17.92	
		19	-	-	-	-	10.94	6.30	1.88	22.40	10.85	7.42	1.87	22.10	10.66	8.33	1.92	48.02	10.68	9.62	1.84	21.51	
		20	-	-	-	-	12.85	6.32	2.22	29.84	12.76	7.44	2.21	29.48	12.67	8.55	2.19	29.12	12.57	9.65	2.17	28.71	
6	15	4.51	4.51	0.65	3.35	5.65	5.65	0.81	5.27	6.79	6.79	0.97	7.21	7.91	7.91	1.13	9.34	9.01	9.01	1.29	11.68		
	17	5.83	4.51	0.83	5.56	5.97	5.67	0.86	5.80	6.80	6.79	0.97	7.23	7.92	7.92	1.14	9.38	9.03	9.03	1.29	11.72		
	19	-	-	-	-	9.44	5.70	1.35	12.65	9.35	6.82	1.34	12.43	9.28	7.93	1.33	12.27	9.44	9.06	1.35	12.64		
	20	-	-	-	-	11.35	5.72	1.63	17.38	11.26	6.84	1.62	17.15	11.17	7.95	1.60	16.89	11.07	9.05	1.59	16.62		
9	3	15	5.19	5.18	1.49	14.94	6.32	6.32	1.81	20.92	7.45	7.45	2.15	28.17	8.54	8.54	2.45	35.30	9.64	9.64	2.79	44.21	
		17	7.58	5.20	2.19	29.08	7.50	6.33	2.17	28.54	7.60	7.47	2.20	29.17	8.55	8.55	2.46	35.41	9.66	9.66	2.80	44.36	
		19	-	-	-	-	11.04	6.34	3.18	55.39	10.97	7.46	3.16	54.69	10.87	8.57	3.13	53.85	10.77	9.66	3.10	53.02	
		20	-	-	-	-	12.96	6.36	3.76	74.34	12.87	7.49	3.74	73.45	12.78	8.60	3.71	72.56	12.69	9.70	3.68	71.64	
	4	15	4.58	4.58	0.99	7.33	5.73	5.73	1.23	10.72	6.85	6.85	1.47	14.57	7.97	7.97	1.72	18.99	9.07	9.07	1.96	23.86	
		17	6.04	4.59	1.30	11.73	6.09	5.74	1.31	11.90	6.86	6.84	1.48	14.61	7.98	7.98	1.72	19.05	9.08	9.08	1.97	23.93	
		19	-	-	-	-	9.60	5.76	2.08	26.33	9.51	6.88	2.06	25.90	9.42	7.99	2.04	25.50	9.48	9.11	2.05	25.74	
		20	-	-	-	-	11.46	5.76	2.47	35.47	11.37	6.88	2.45	35.03	11.28	8.00	2.43	34.54	11.18	9.10	2.41	33.99	
	5	15	3.96	3.96	0.68	3.81	5.12	5.12	0.88	6.03	6.26	6.26	1.08	8.48	7.38	7.38	1.27	11.23	8.49	8.49	1.47	14.36	
		17	4.47	3.97	0.77	4.79	5.15	5.14	0.89	6.08	6.27	6.27	1.08	8.51	7.39	7.39	1.27	11.27	8.51	8.51	1.47	14.40	
		19	-	-	-	-	8.02	5.15	1.38	12.96	7.94	6.28	1.37	12.73	7.98	7.41	1.37	12.84	8.56	8.53	1.48	14.55	
		20	-	-	-	-	9.94	5.17	1.71	18.73	9.85	6.30	1.70	18.44	9.75	7.41	1.68	18.13	9.69	8.52	1.67	17.93	
6	15	3.41	3.41	0.49	1.65	4.51	4.51	0.65	3.40	5.66	5.66	0.81	5.21	6.79	6.79	0.97	7.10	7.90	7.90	1.13	9.20		
	17	3.49	3.43	0.50	1.76	4.52	4.52	0.65	3.42	5.67	5.67	0.81	5.23	6.80	6.80	0.98	7.13	7.92	7.92	1.14	9.23		
	19	-	-	-	-	6.37	4.54	0.91	6.37	6.39	6.39	0.92	6.40	6.93	6.83	0.99	7.35	7.93	7.93	1.14	9.26		
	20	-	-	-	-	8.32	4.57	1.19	10.04	8.23	5.70	1.18	9.85	8.17	6.82	1.17	9.73	8.37	7.95	1.20	10.15		

Continued:

MDVF-1200D3E																							
EWT	ΔT	Indoor temp (W.B.)	Indoor temperature (D.B.)																				
			21				23				25				27				29				
			TC	SC	WF	WPD	TC	SC	WF	WPD	TC	SC	WF	WPD	TC	SC	WF	WPD	TC	SC	WF	WPD	
°C	°C	°C	kW	kW	m ³ /h	kPa	kW	kW	m ³ /h	kPa	kW	kW	m ³ /h	kPa	kW	kW	m ³ /h	kPa	kW	kW	m ³ /h	kPa	
11	3	15	4.04	4.04	1.15	9.44	5.18	5.18	1.48	14.58	6.30	6.30	1.80	20.31	7.42	7.42	2.12	26.99	8.52	8.52	2.44	34.50	
		17	4.63	4.04	1.32	11.94	5.19	5.17	1.49	14.62	6.31	6.31	1.80	20.38	7.43	7.43	2.12	27.08	8.54	8.54	2.45	34.61	
		19	-	-	-	-	8.14	5.20	2.33	31.67	8.05	6.32	2.30	31.06	8.02	7.44	2.29	30.86	8.55	8.54	2.45	34.74	
		20	-	-	-	-	10.03	5.20	2.87	45.59	9.95	6.33	2.84	44.92	9.85	7.45	2.82	44.18	9.76	8.55	2.79	43.49	
	4	15	3.43	3.43	0.73	4.37	4.58	4.58	0.98	7.16	5.72	5.72	1.22	10.45	6.84	6.84	1.46	14.19	7.94	7.94	1.70	18.37	
		17	3.46	3.46	0.74	4.44	4.59	4.59	0.98	7.18	5.73	5.73	1.23	10.48	6.85	6.85	1.47	14.24	7.95	7.95	1.70	18.43	
		19	-	-	-	-	6.53	4.60	1.40	13.12	6.51	5.73	1.39	13.04	6.94	6.88	1.49	14.57	7.97	7.97	1.71	18.49	
		20	-	-	-	-	8.45	4.61	1.81	20.43	8.35	5.74	1.79	20.04	8.28	6.86	1.77	19.73	8.37	7.99	1.79	20.11	
	5	15	2.86	2.86	0.49	1.71	3.98	3.98	0.69	3.85	5.13	5.13	0.88	5.96	6.26	6.26	1.08	8.36	7.37	7.37	1.27	11.06	
		17	2.86	2.86	0.49	1.72	3.99	3.99	0.69	3.87	5.14	5.14	0.89	5.98	6.27	6.27	1.08	8.39	7.39	7.39	1.27	11.09	
		19	-	-	-	-	4.88	3.99	0.84	5.47	5.30	5.17	0.91	6.30	6.29	6.28	1.08	8.41	7.40	7.40	1.28	11.13	
		20	-	-	-	-	6.79	4.02	1.17	9.59	6.72	5.15	1.16	9.43	6.82	6.30	1.17	9.67	7.46	7.42	1.28	11.27	
	6	15	2.33	2.33	0.33	0.74	3.41	3.41	0.49	1.71	4.52	4.52	0.65	3.46	5.66	5.66	0.81	5.10	6.78	6.78	0.97	6.94	
		17	2.34	2.34	0.34	0.75	3.42	3.42	0.49	1.72	4.53	4.53	0.65	3.47	5.67	5.67	0.81	5.11	6.80	6.80	0.97	6.96	
		19	-	-	-	-	3.58	3.43	0.51	1.96	4.54	4.52	0.65	3.48	5.68	5.68	0.81	5.13	6.81	6.81	0.97	6.99	
		20	-	-	-	-	4.97	3.39	0.71	4.12	5.07	4.55	0.73	4.26	5.75	5.70	0.82	5.25	6.82	6.81	0.97	7.00	
	13	3	15	2.88	2.88	0.83	5.31	4.04	4.04	1.16	9.42	5.16	5.16	1.47	14.18	6.29	6.29	1.81	20.23	7.39	7.39	2.12	26.61
			17	2.89	2.89	0.83	5.33	4.05	4.05	1.16	9.45	5.17	5.17	1.48	14.23	6.30	6.30	1.81	20.29	7.41	7.41	2.12	26.68
			19	-	-	-	-	4.98	4.03	1.42	13.31	5.29	5.22	1.52	14.97	6.32	6.32	1.82	20.36	7.42	7.42	2.13	26.77
			20	-	-	-	-	6.91	4.06	1.99	23.77	6.83	5.19	1.96	23.28	6.83	6.32	1.96	23.33	7.43	7.41	2.13	26.82
		4	15	2.29	2.29	0.49	1.77	3.43	3.43	0.74	4.36	4.58	4.58	0.98	7.03	5.71	5.71	1.22	10.26	6.82	6.82	1.46	13.94
			17	2.29	2.29	0.49	1.77	3.44	3.44	0.74	4.38	4.58	4.58	0.98	7.05	5.72	5.72	1.23	10.29	6.83	6.83	1.46	13.98
			19	-	-	-	-	3.57	3.47	0.77	4.66	4.59	4.58	0.98	7.07	5.73	5.73	1.23	10.33	6.85	6.85	1.47	14.03
			20	-	-	-	-	5.14	3.45	1.10	8.57	5.17	4.60	1.11	8.66	5.78	5.75	1.24	10.50	6.85	6.85	1.47	14.06
5		15	1.75	1.75	0.30	0.64	2.84	2.84	0.49	1.74	3.98	3.98	0.68	3.78	5.12	5.12	0.88	5.81	6.25	6.25	1.07	8.15	
		17	1.76	1.76	0.30	0.65	2.85	2.85	0.49	1.75	3.99	3.99	0.68	3.79	5.13	5.13	0.88	5.83	6.26	6.26	1.07	8.17	
		19	-	-	-	-	2.85	2.83	0.49	1.76	4.00	4.00	0.69	3.81	5.14	5.14	0.88	5.85	6.27	6.27	1.08	8.20	
		20	-	-	-	-	3.34	2.83	0.57	2.64	4.05	4.02	0.69	3.90	5.15	5.15	0.88	5.86	6.28	6.28	1.08	8.22	
6		15	1.20	1.20	0.17	0.36	2.33	2.33	0.33	0.71	3.40	3.40	0.49	1.75	4.52	4.52	0.65	3.43	5.66	5.66	0.81	5.04	
		17	1.20	1.20	0.17	0.36	2.33	2.33	0.33	0.71	3.41	3.41	0.49	1.76	4.53	4.53	0.65	3.44	5.68	5.68	0.81	5.05	
		19	-	-	-	-	2.34	2.34	0.33	0.72	3.42	3.42	0.49	1.77	4.54	4.54	0.65	3.45	5.69	5.69	0.81	5.07	
		20	-	-	-	-	2.45	2.36	0.35	0.77	3.42	3.41	0.49	1.78	4.55	4.55	0.65	3.46	5.69	5.69	0.81	5.08	
15		3	15	1.72	1.72	0.49	1.78	2.88	2.88	0.82	5.15	4.02	4.02	1.15	9.13	5.15	5.15	1.47	13.96	6.27	6.27	1.80	19.86
			17	1.72	1.72	0.49	1.79	2.88	2.88	0.82	5.16	4.03	4.03	1.15	9.16	5.16	5.16	1.47	14.00	6.29	6.29	1.81	19.93
			19	-	-	-	-	2.89	2.88	0.82	5.18	4.04	4.04	1.15	9.19	5.17	5.17	1.48	14.05	6.30	6.30	1.81	20.00
			20	-	-	-	-	3.50	2.89	1.00	7.18	4.07	4.06	1.16	9.29	5.18	5.18	1.48	14.08	6.31	6.31	1.81	20.04
		4	15	1.18	1.18	0.25	0.52	2.28	2.28	0.49	1.80	3.43	3.43	0.74	4.25	4.58	4.58	0.98	6.93	5.71	5.71	1.23	10.22
			17	1.18	1.18	0.25	0.53	2.29	2.29	0.49	1.81	3.44	3.44	0.74	4.27	4.58	4.58	0.98	6.96	5.72	5.72	1.23	10.25
			19	-	-	-	-	2.29	2.29	0.49	1.82	3.45	3.45	0.74	4.28	4.59	4.59	0.98	6.98	5.73	5.73	1.24	10.29
			20	-	-	-	-	2.31	2.29	0.49	1.85	3.45	3.45	0.74	4.29	4.60	4.60	0.99	7.00	5.74	5.74	1.24	10.31
	5	15	0.62	0.62	0.11	0.21	1.76	1.76	0.30	0.62	2.85	2.85	0.49	1.84	3.99	3.99	0.69	3.78	5.13	5.13	0.88	5.78	
		17	0.62	0.62	0.11	0.21	1.77	1.77	0.30	0.62	2.85	2.85	0.49	1.85	4.00	4.00	0.69	3.79	5.14	5.14	0.89	5.80	
		19	-	-	-	-	1.77	1.77	0.31	0.62	2.86	2.86	0.49	1.86	4.01	4.01	0.69	3.80	5.15	5.15	0.89	5.82	
		20	-	-	-	-	1.77	1.76	0.31	0.62	2.86	2.86	0.49	1.86	4.01	4.01	0.69	3.81	5.15	5.15	0.89	5.83	
	6	15	-	-	-	-	1.20	1.20	0.17	0.34	2.33	2.33	0.34	0.70	3.40	3.40	0.49	1.84	4.53	4.53	0.65	3.43	
		17	-	-	-	-	1.20	1.20	0.17	0.34	2.34	2.34	0.34	0.71	3.41	3.41	0.49	1.84	4.54	4.54	0.65	3.44	
		19	-	-	-	-	1.21	1.21	0.17	0.34	2.34	2.34	0.34	0.71	3.42	3.42	0.49	1.85	4.55	4.55	0.65	3.45	
		20	-	-	-	-	1.21	1.21	0.17	0.35	2.35	2.35	0.34	0.71	3.42	3.42	0.49	1.86	4.56	4.56	0.65	3.46	

Cooling capacity

MDVF-1400D3E																						
EWT	ΔT	Indoor temp (W.B.)	Indoor temperature (D.B.)																			
			21				23				25				27				29			
°C	°C	°C	TC	SC	WF	WPD	TC	SC	WF	WPD	TC	SC	WF	WPD	TC	SC	WF	WPD	TC	SC	WF	WPD
			kW	kW	m ³ /h	kPa	kW	kW	m ³ /h	kPa	kW	kW	m ³ /h	kPa	kW	kW	m ³ /h	kPa	kW	kW	m ³ /h	kPa
5	3	15	11.65	9.11	3.34	68.46	11.56	10.46	3.32	67.70	11.86	11.82	3.42	71.51	13.11	13.11	3.76	84.30	14.42	14.42	4.14	99.73
		17	15.68	9.14	4.55	117.40	15.58	10.50	4.52	116.05	15.48	11.83	4.49	114.60	15.35	13.15	4.45	112.95	15.24	14.46	4.38	109.98
		19	-	-	-	-	19.84	10.51	5.72	175.85	19.72	11.85	5.69	173.86	19.59	13.17	5.65	171.86	19.46	14.48	5.61	169.90
		20	-	-	-	-	22.11	10.52	6.38	212.80	21.98	11.87	6.34	210.46	21.84	13.19	6.30	208.13	21.70	14.51	6.26	205.84
	4	15	10.10	8.40	2.17	32.11	10.16	9.77	2.18	32.48	11.10	11.10	2.38	37.86	12.43	12.43	2.67	46.10	13.74	13.74	2.96	55.18
		17	14.16	8.44	3.06	58.42	14.06	9.80	3.04	57.71	13.95	11.13	3.01	56.90	13.83	12.45	2.98	55.75	14.01	13.79	3.03	57.36
		19	-	-	-	-	18.35	9.82	3.97	92.15	18.23	11.17	3.95	91.07	18.11	12.50	3.92	90.02	17.99	13.81	3.89	88.95
		20	-	-	-	-	20.63	9.84	4.47	113.33	20.50	11.19	4.45	112.24	20.32	12.50	4.38	109.31	20.19	13.81	4.35	108.06
	5	15	8.59	7.71	1.48	16.57	9.15	9.09	1.58	18.51	10.41	10.41	1.79	22.91	11.74	11.74	2.01	28.20	13.06	13.06	2.25	34.19
		17	12.57	7.73	2.17	31.97	12.47	9.09	2.15	31.51	12.36	10.43	2.13	31.05	12.41	11.78	2.14	31.28	13.10	13.10	2.26	34.37
		19	-	-	-	-	16.75	9.11	2.88	52.26	16.65	10.46	2.87	51.92	16.54	11.79	2.85	51.35	16.38	13.10	2.81	50.22
		20	-	-	-	-	19.04	9.13	3.28	65.62	18.91	10.48	3.25	64.69	18.78	11.81	3.23	63.84	18.67	13.13	3.21	63.38
6	15	7.28	7.00	1.04	9.06	8.38	8.37	1.20	11.56	9.73	9.73	1.40	14.93	11.05	11.05	1.58	18.47	12.37	12.37	1.77	22.43	
	17	10.88	7.01	1.56	17.96	10.77	8.37	1.54	17.66	10.77	9.72	1.54	17.67	11.28	11.08	1.61	19.13	12.40	12.40	1.77	22.51	
	19	-	-	-	-	15.16	8.42	2.18	32.05	15.05	9.77	2.16	31.65	14.93	11.11	2.14	31.20	14.81	12.43	2.13	30.77	
	20	-	-	-	-	17.44	8.44	2.50	40.86	17.32	9.79	2.49	40.37	17.16	11.11	2.46	39.50	17.04	12.43	2.44	38.99	
7	3	15	8.61	7.73	2.49	40.44	9.10	9.09	2.61	44.00	10.43	10.43	3.00	55.87	11.77	11.77	3.41	70.00	13.08	13.08	3.80	84.38
		17	12.60	7.74	3.63	77.90	12.50	9.10	3.60	76.83	12.38	10.44	3.57	75.57	12.35	11.78	3.55	75.15	13.11	13.10	3.80	84.64
		19	-	-	-	-	16.80	9.13	4.86	129.96	16.70	10.48	4.85	129.48	16.59	11.82	4.82	127.93	16.45	13.12	4.76	125.11
		20	-	-	-	-	19.10	9.16	5.57	165.41	18.98	10.51	5.54	163.56	18.86	11.84	5.50	161.71	18.73	13.16	5.47	159.77
	4	15	7.25	7.04	1.56	17.95	8.39	8.39	1.80	23.08	9.76	9.76	2.11	30.23	11.07	11.07	2.38	37.28	12.40	12.40	2.68	45.88
		17	10.95	7.03	2.36	36.60	10.85	8.40	2.33	35.99	10.79	9.75	2.32	35.67	11.21	11.10	2.41	38.13	12.42	12.42	2.69	46.03
		19	-	-	-	-	15.17	8.42	3.27	64.63	15.08	9.78	3.26	64.25	14.97	11.12	3.24	63.59	14.85	12.44	3.22	62.84
		20	-	-	-	-	17.48	8.46	3.79	83.82	17.34	9.80	3.75	82.06	17.24	11.13	3.74	81.68	17.11	12.46	3.70	80.32
	5	15	6.33	6.32	1.09	9.65	7.70	7.70	1.32	13.48	9.05	9.05	1.56	17.79	10.39	10.39	1.79	22.57	11.72	11.72	2.03	28.03
		17	9.24	6.33	1.59	18.42	9.17	7.69	1.58	18.18	9.46	9.08	1.63	19.20	10.41	10.40	1.79	22.64	11.75	11.75	2.03	28.12
		19	-	-	-	-	13.50	7.73	2.32	35.50	13.39	9.08	2.30	35.00	13.18	10.83	2.37	57.13	13.20	11.74	2.27	34.14
		20	-	-	-	-	15.81	7.76	2.74	47.12	15.71	9.12	2.72	46.55	15.59	10.45	2.70	45.97	15.46	11.78	2.67	45.32
6	15	5.59	5.59	0.80	5.71	6.99	6.99	1.00	8.34	8.36	8.36	1.20	11.30	9.70	9.70	1.39	14.59	11.04	11.04	1.59	18.26	
	17	7.44	5.60	1.07	9.25	7.63	7.01	1.09	9.67	8.44	8.38	1.21	11.49	9.72	9.72	1.39	14.64	11.06	11.06	1.59	18.33	
	19	-	-	-	-	11.76	7.03	1.69	20.36	11.65	8.39	1.67	20.02	11.57	9.73	1.66	19.80	11.79	11.09	1.69	20.45	
	20	-	-	-	-	14.07	7.05	2.03	27.84	13.96	8.41	2.01	27.46	13.84	9.76	1.99	27.05	13.73	11.08	1.98	26.66	
9	3	15	6.34	6.32	1.82	23.18	7.70	7.70	2.21	32.51	9.07	9.07	2.63	43.75	10.39	10.39	2.99	54.81	11.71	11.71	3.37	67.64
		17	9.33	6.36	2.70	45.94	9.24	7.73	2.68	45.16	9.36	9.10	2.71	46.21	10.41	10.41	3.00	54.98	11.73	11.73	3.41	68.75
		19	-	-	-	-	13.57	7.75	3.94	88.87	13.47	9.11	3.91	87.54	13.31	10.43	3.84	84.78	13.20	11.75	3.81	83.58
		20	-	-	-	-	15.84	7.77	4.62	117.12	15.73	9.12	4.58	115.61	15.62	10.47	4.55	114.21	15.50	11.79	4.52	112.65
	4	15	5.64	5.64	1.21	11.50	7.02	7.02	1.51	16.77	8.39	8.39	1.82	22.99	9.71	9.71	2.09	29.30	11.04	11.04	2.38	36.61
		17	7.54	5.65	1.63	19.01	7.62	7.04	1.64	19.35	8.42	8.41	1.82	23.10	9.73	9.73	2.10	29.40	11.06	11.06	2.38	36.73
		19	-	-	-	-	11.84	7.06	2.56	41.73	11.72	8.41	2.54	41.03	11.62	9.76	2.52	40.41	11.70	11.10	2.53	40.89
		20	-	-	-	-	14.11	7.07	3.06	56.76	14.01	8.43	3.04	56.02	13.89	9.77	3.01	55.21	13.77	11.10	2.99	54.36
	5	15	4.93	4.93	0.85	6.21	6.32	6.32	1.09	9.48	7.69	7.69	1.32	13.26	9.03	9.03	1.56	17.50	10.37	10.37	1.79	22.19
		17	5.75	4.93	0.99	8.07	6.46	6.34	1.11	9.84	7.70	7.70	1.33	13.30	9.05	9.05	1.56	17.56	10.39	10.39	1.79	22.26
		19	-	-	-	-	9.98	6.34	1.72	20.75	9.89	7.70	1.70	20.43	9.96	9.07	1.71	20.68	10.57	10.42	1.82	22.95
		20	-	-	-	-	12.29	6.36	2.12	29.76	12.18	7.72	2.10	29.29	12.06	9.07	2.08	28.81	12.00	10.40	2.07	28.59
6	15	4.20	4.20	0.60	3.17	5.61	5.61	0.80	5.64	6.99	6.99	1.00	8.21	8.35	8.35	1.20	11.12	9.69	9.69	1.39	14.35	
	17	4.38	4.22	0.63	3.50	5.62	5.60	0.81	5.66	7.00	7.00	1.00	8.24	8.37	8.37	1.20	11.16	9.71	9.71	1.39	14.39	
	19	-	-	-	-	8.06	5.62	1.16	10.46	8.12	7.01	1.16	10.58	8.71	8.39	1.25	11.95	9.73	9.72	1.40	14.45	
	20	-	-	-	-	10.39	5.65	1.49	16.17	10.28	7.01	1.47	15.87	10.23	8.37	1.47	15.74	10.50	9.74	1.51	16.47	

Continued:

MDVF-1400D3E																							
EWT	ΔT	Indoor temp (W.B.)	Indoor temperature (D.B.)																				
			21				23				25				27				29				
			TC	SC	WF	WPD	TC	SC	WF	WPD	TC	SC	WF	WPD	TC	SC	WF	WPD	TC	SC	WF	WPD	
°C	°C	°C	kW	kW	m³/h	kPa	kW	kW	m³/h	kPa	kW	kW	m³/h	kPa	kW	kW	m³/h	kPa	kW	kW	m³/h	kPa	
11	3	15	4.96	4.96	1.42	14.86	6.33	6.33	1.81	22.52	7.69	7.69	2.19	31.55	9.04	9.04	2.60	42.41	10.37	10.37	2.99	53.93	
		17	5.78	4.95	1.65	19.24	6.38	6.36	1.82	22.85	7.70	7.70	2.20	31.66	9.06	9.06	2.61	42.55	10.39	10.39	2.99	54.11	
		19	-	-	-	-	10.05	6.36	2.89	51.00	9.90	7.71	2.83	49.06	9.88	9.06	2.82	48.88	10.46	10.43	3.01	54.74	
		20	-	-	-	-	12.33	6.37	3.56	73.18	12.23	7.74	3.53	72.11	12.12	9.09	3.50	70.97	12.02	10.42	3.47	69.95	
	4	15	4.24	4.24	0.91	6.91	5.63	5.63	1.21	11.21	7.00	7.00	1.50	16.28	8.35	8.35	1.79	22.06	9.69	9.69	2.08	28.57	
		17	4.39	4.28	0.94	7.33	5.65	5.64	1.21	11.24	7.01	7.01	1.50	16.32	8.37	8.37	1.79	22.13	9.71	9.71	2.08	28.67	
		19	-	-	-	-	8.11	5.64	1.74	20.95	8.10	7.01	1.74	20.91	8.60	8.40	1.84	23.19	9.73	9.72	2.09	28.77	
		20	-	-	-	-	10.46	5.67	2.25	32.72	10.34	7.03	2.22	32.10	10.26	8.39	2.21	31.65	10.38	9.75	2.23	32.33	
	5	15	3.52	3.52	0.61	3.28	4.93	4.93	0.85	6.14	6.32	6.32	1.09	9.34	7.66	7.66	1.31	12.91	9.02	9.02	1.55	17.21	
		17	3.53	3.51	0.61	3.29	4.95	4.95	0.85	6.16	6.33	6.33	1.09	9.38	7.68	7.68	1.32	12.95	9.04	9.04	1.56	17.27	
		19	-	-	-	-	6.21	4.94	1.07	9.07	6.71	6.36	1.16	10.35	7.70	7.70	1.32	13.02	9.06	9.06	1.56	17.34	
		20	-	-	-	-	8.49	4.96	1.46	15.50	8.42	6.33	1.45	15.26	8.56	7.72	1.48	15.72	9.25	9.08	1.59	17.97	
	6	15	2.88	2.88	0.41	1.20	4.21	4.21	0.60	3.26	5.60	5.60	0.80	5.52	6.98	6.98	1.00	8.02	8.33	8.33	1.19	10.85	
		17	2.89	2.89	0.41	1.20	4.22	4.22	0.61	3.28	5.61	5.61	0.80	5.53	6.99	6.99	1.00	8.04	8.35	8.35	1.19	10.89	
		19	-	-	-	-	4.57	4.24	0.66	3.90	5.65	5.64	0.81	5.60	7.01	7.01	1.00	8.07	8.36	8.36	1.20	10.93	
		20	-	-	-	-	6.36	4.22	0.91	6.84	6.52	5.63	0.93	7.14	7.29	7.02	1.04	8.63	8.38	8.37	1.20	10.95	
	13	3	15	3.56	3.56	1.02	8.35	4.93	4.93	1.41	14.45	6.32	6.32	1.82	22.42	7.66	7.66	2.19	30.95	9.01	9.01	2.58	41.32
			17	3.56	3.56	1.02	8.37	4.94	4.94	1.41	14.50	6.33	6.33	1.82	22.49	7.67	7.67	2.19	31.06	9.02	9.02	2.59	41.45
			19	-	-	-	-	6.23	4.95	1.79	21.86	6.56	6.37	1.89	23.94	7.69	7.68	2.20	31.16	9.04	9.04	2.59	41.60
			20	-	-	-	-	8.49	4.96	2.43	37.04	8.40	6.33	2.40	36.34	8.42	7.70	2.41	36.55	9.09	9.07	2.61	42.03
		4	15	2.83	2.83	0.61	3.34	4.23	4.23	0.91	6.78	5.62	5.62	1.20	11.00	6.99	6.99	1.51	16.17	8.33	8.33	1.80	21.89
			17	2.83	2.83	0.61	3.36	4.24	4.24	0.91	6.80	5.63	5.63	1.21	11.04	7.01	7.01	1.51	16.22	8.35	8.35	1.80	21.97
			19	-	-	-	-	4.55	4.27	0.97	7.66	5.64	5.63	1.21	11.08	7.02	7.02	1.51	16.29	8.37	8.37	1.80	22.05
			20	-	-	-	-	6.44	4.25	1.38	13.91	6.54	5.65	1.41	14.39	7.20	7.05	1.55	17.00	8.38	8.37	1.81	22.08
5		15	2.17	2.17	0.37	0.95	3.51	3.51	0.60	3.28	4.92	4.92	0.84	5.98	6.30	6.30	1.08	9.10	7.65	7.65	1.31	12.70	
		17	2.18	2.18	0.37	0.96	3.52	3.52	0.60	3.30	4.94	4.94	0.85	6.00	6.31	6.31	1.08	9.13	7.67	7.67	1.32	12.74	
		19	-	-	-	-	3.53	3.52	0.61	3.32	4.94	4.94	0.85	6.02	6.33	6.33	1.09	9.16	7.68	7.68	1.32	12.79	
		20	-	-	-	-	4.38	3.53	0.75	4.89	5.17	4.97	0.89	6.49	6.33	6.32	1.09	9.18	7.69	7.69	1.32	12.82	
6		15	1.49	1.49	0.21	0.49	2.87	2.87	0.41	1.22	4.21	4.21	0.60	3.28	5.61	5.61	0.80	5.45	6.97	6.97	1.00	7.90	
		17	1.50	1.50	0.21	0.49	2.87	2.87	0.41	1.22	4.22	4.22	0.60	3.29	5.62	5.62	0.80	5.46	6.99	6.99	1.00	7.92	
		19	-	-	-	-	2.88	2.88	0.41	1.23	4.23	4.23	0.60	3.31	5.63	5.63	0.81	5.48	7.00	7.00	1.00	7.95	
		20	-	-	-	-	3.06	2.89	0.44	1.46	4.23	4.21	0.60	3.31	5.64	5.64	0.81	5.50	7.01	7.01	1.00	7.97	
15		3	15	-	-	-	3.54	3.54	1.01	8.08	4.94	4.94	1.42	14.47	6.28	6.28	1.79	21.65	7.63	7.63	2.18	30.37	
			17	2.13	2.13	0.61	3.35	3.55	3.55	1.01	8.11	4.94	4.94	1.41	14.27	6.30	6.30	1.80	21.72	7.65	7.65	2.19	30.47
			19	-	-	-	-	3.55	3.53	1.01	8.12	4.96	4.96	1.43	14.57	6.31	6.31	1.80	21.80	7.66	7.66	2.19	30.58
			20	-	-	-	-	4.41	3.55	1.26	11.76	5.07	5.00	1.46	15.10	6.31	6.31	1.80	21.84	7.67	7.67	2.19	30.64
		4	15	1.11	1.11	0.04	0.08	2.83	2.83	0.61	3.33	4.24	4.24	0.91	6.69	5.62	5.62	1.21	10.97	6.98	6.98	1.50	15.88
			17	1.47	1.47	0.32	0.72	2.83	2.83	0.61	3.34	4.24	4.24	0.91	6.72	5.64	5.64	1.21	11.00	6.99	6.99	1.51	15.94
			19	-	-	-	-	2.84	2.84	0.61	3.36	4.25	4.25	0.91	6.74	5.65	5.65	1.22	11.04	7.00	7.00	1.51	15.99
			20	-	-	-	-	2.92	2.88	0.63	3.54	4.26	4.24	0.91	6.75	5.65	5.65	1.22	11.06	7.01	7.01	1.51	16.02
	5	15	0.45	0.45	0.04	0.09	2.18	2.18	0.38	0.98	3.53	3.53	0.61	3.35	4.93	4.93	0.85	5.94	6.29	6.29	1.09	9.03	
		17	0.14	0.14	0.02	0.04	2.18	2.18	0.38	0.99	3.54	3.54	0.61	3.37	4.94	4.94	0.85	5.97	6.31	6.31	1.09	9.06	
		19	-	-	-	-	2.19	2.19	0.38	0.99	3.54	3.54	0.61	3.38	4.95	4.95	0.85	5.99	6.32	6.32	1.09	9.09	
		20	-	-	-	-	2.19	2.17	0.38	0.99	3.55	3.55	0.61	3.39	4.95	4.95	0.85	6.00	6.33	6.33	1.09	9.11	
	6	15	-	-	-	-	1.49	1.49	0.21	0.47	2.86	2.86	0.41	1.27	4.22	4.22	0.61	3.31	5.61	5.61	0.81	5.40	
		17	-	-	-	-	1.50	1.50	0.22	0.47	2.87	2.87	0.41	1.27	4.22	4.22	0.61	3.33	5.62	5.62	0.81	5.42	
		19	-	-	-	-	1.50	1.50	0.22	0.47	2.87	2.87	0.41	1.28	4.23	4.23	0.61	3.34	5.63	5.63	0.81	5.44	
		20	-	-	-	-	1.50	1.50	0.22	0.47	2.88	2.88	0.41	1.29	4.24	4.24	0.61	3.35	5.64	5.64	0.81	5.45	

Cooling capacity modification coefficient table:

Speed	200		300		400		500		600		800		1000		1200		1400	
	TC	SC	TC	SC	TC	SC	TC	SC	TC	SC	TC	SC	TC	SC	TC	SC	TC	SC
High	1	1	1	1	1	1	1	1	1	1	1	1	1	1	1	1	1	1
Med	0.86	0.82	0.87	0.83	0.85	0.81	0.86	0.83	0.84	0.8	0.84	0.82	0.87	0.84	0.89	0.85	0.86	0.81
Low	0.76	0.72	0.74	0.7	0.74	0.71	0.75	0.71	0.77	0.73	0.76	0.73	0.73	0.7	0.76	0.71	0.76	0.72

3-row Duct 12Pa Heating Capacity

EWT: Enter Water Temp. (°C) **Δt:** Temperature Difference (°C) **DB:** Dry Bulb Temp. (°C) **WB:** Wet Bulb Temp. (°C)
TC: Total Cooling Capacity (kW) **SC:** Sensible Cooling Capacity (kW) **WF:** Water Flow (m³/h) **WPD:** Water Pressure Drop (kPa)

MDVF-200D3E													
EWT	ΔT	Indoor temperature (W.B.)											
		16			18			20			22		
		TH	WF	WPD	TH	WF	WPD	TH	WF	WPD	TH	WF	WPD
°C	°C	kW	m³/h	kPa	kW	m³/h	kPa	kW	m³/h	kPa	kW	m³/h	kPa
40	8	1.90	0.20	2.71	1.65	0.18	2.14	1.41	0.15	1.63	1.16	0.13	1.09
	10	1.65	0.14	1.44	1.40	0.12	0.98	1.17	0.10	0.61	0.94	0.08	0.36
	12	1.41	0.10	0.60	1.18	0.09	0.40	0.94	0.07	0.30	0.71	0.05	0.23
	14	1.18	0.07	0.33	0.95	0.06	0.27	0.71	0.04	0.20	0.48	0.03	0.14
	16	0.95	0.05	0.24	0.71	0.04	0.18	0.48	0.03	0.12	0.24	0.01	0.06
45	8	2.51	0.27	4.25	2.26	0.24	3.55	2.01	0.22	2.92	1.77	0.19	2.34
	10	2.27	0.20	2.45	2.02	0.17	2.01	1.77	0.15	1.61	1.52	0.13	1.24
	12	2.02	0.15	1.49	1.77	0.13	1.15	1.52	0.11	0.80	1.29	0.09	0.51
	14	1.77	0.11	0.77	1.53	0.09	0.52	1.30	0.08	0.35	1.07	0.07	0.27
	16	1.55	0.08	0.39	1.31	0.07	0.30	1.07	0.06	0.25	0.83	0.05	0.19
50	8	3.12	0.34	6.02	2.87	0.31	5.21	2.62	0.28	4.46	2.37	0.26	3.76
	10	2.88	0.25	3.62	2.63	0.23	3.09	2.38	0.21	2.61	2.13	0.18	2.17
	12	2.64	0.19	2.28	2.38	0.17	1.93	2.14	0.15	1.60	1.89	0.14	1.30
	14	2.39	0.15	1.50	2.13	0.13	1.23	1.88	0.12	0.95	1.64	0.10	0.67
	16	2.14	0.12	0.92	1.89	0.10	0.67	1.66	0.09	0.47	1.42	0.08	0.33
55	8	3.72	0.40	8.03	3.47	0.37	7.10	3.22	0.35	6.23	2.97	0.32	5.42
	10	3.49	0.30	4.92	3.24	0.28	4.32	2.99	0.26	3.76	2.74	0.24	3.24
	12	3.25	0.23	3.19	3.00	0.22	2.78	2.75	0.20	2.39	2.50	0.18	2.03
	14	3.01	0.19	2.17	2.76	0.17	1.87	2.51	0.15	1.59	2.26	0.14	1.33
	16	2.76	0.15	1.50	2.51	0.14	1.27	2.25	0.12	1.05	2.01	0.11	0.82
60	8	4.33	0.47	10.25	4.08	0.44	9.26	3.82	0.41	8.28	3.57	0.39	7.35
	10	4.10	0.35	6.34	3.84	0.33	5.67	3.59	0.31	5.04	3.34	0.29	4.45
	12	3.86	0.28	4.21	3.61	0.26	3.73	3.35	0.24	3.29	3.10	0.22	2.88
	14	3.62	0.22	2.90	3.37	0.21	2.56	3.12	0.19	2.24	2.87	0.18	1.94
	16	3.38	0.18	2.07	3.13	0.17	1.81	2.87	0.15	1.57	2.62	0.14	1.34

Heating capacity

MDVF-300D3E													
EWT	ΔT	Indoor temperature (W.B.)											
		16			18			20			22		
		TH	WF	WPD	TH	WF	WPD	TH	WF	WPD	TH	WF	WPD
°C	°C	kW	m ³ /h	kPa	kW	m ³ /h	kPa	kW	m ³ /h	kPa	kW	m ³ /h	kPa
40	8	2.77	0.30	6.13	2.42	0.26	4.86	2.06	0.22	3.72	1.72	0.19	2.71
	10	2.43	0.21	3.38	2.07	0.18	2.58	1.72	0.15	1.87	1.37	0.12	1.10
	12	2.07	0.15	1.89	1.72	0.12	1.22	1.39	0.10	0.68	1.05	0.08	0.40
	14	1.74	0.11	0.80	1.40	0.09	0.49	1.06	0.07	0.36	0.71	0.04	0.24
	16	1.41	0.08	0.43	1.06	0.06	0.33	0.72	0.04	0.22	0.37	0.02	0.11
45	8	3.64	0.39	9.57	3.28	0.35	8.01	2.93	0.32	6.58	2.58	0.28	5.29
	10	3.30	0.28	5.56	2.95	0.25	4.57	2.59	0.22	3.67	2.24	0.19	2.87
	12	2.96	0.21	3.42	2.61	0.19	2.75	2.25	0.16	2.14	1.90	0.14	1.59
	14	2.61	0.16	2.14	2.25	0.14	1.63	1.90	0.12	1.10	1.56	0.10	0.65
	16	2.26	0.12	1.20	1.92	0.10	0.77	1.58	0.09	0.48	1.24	0.07	0.34
50	8	4.50	0.49	13.55	4.14	0.45	11.73	3.79	0.41	10.04	3.43	0.37	8.47
	10	4.17	0.36	8.15	3.81	0.33	6.98	3.46	0.30	5.89	3.11	0.27	4.90
	12	3.84	0.28	5.17	3.48	0.25	4.37	3.12	0.22	3.63	2.77	0.20	2.96
	14	3.50	0.22	3.41	3.14	0.19	2.84	2.78	0.17	2.31	2.43	0.15	1.84
	16	3.15	0.17	2.30	2.79	0.15	1.88	2.43	0.13	1.46	2.08	0.11	1.02
55	8	5.37	0.58	18.15	5.00	0.54	16.06	4.65	0.50	14.10	4.29	0.46	12.20
	10	5.04	0.44	11.07	4.68	0.40	9.73	4.32	0.37	8.47	3.97	0.34	7.30
	12	4.71	0.34	7.19	4.35	0.31	6.26	3.99	0.29	5.40	3.63	0.26	4.60
	14	4.38	0.27	4.90	4.02	0.25	4.23	3.66	0.23	3.60	3.30	0.20	3.03
	16	4.03	0.22	3.41	3.67	0.20	2.90	3.32	0.18	2.44	2.96	0.16	2.01
60	8	6.24	0.67	23.06	5.87	0.63	20.73	5.50	0.59	18.52	5.15	0.56	16.55
	10	5.91	0.51	14.32	5.54	0.48	12.76	5.18	0.45	11.34	4.82	0.42	10.01
	12	5.58	0.40	9.48	5.22	0.38	8.43	4.85	0.35	7.44	4.50	0.32	6.52
	14	5.25	0.32	6.54	4.89	0.30	5.78	4.52	0.28	5.06	4.17	0.26	4.39
	16	4.92	0.27	4.68	4.55	0.25	4.10	4.19	0.23	3.56	3.83	0.21	3.05

Heating capacity

MDVF-400D3E													
EWT	ΔT	Indoor temperature (W.B.)											
		16			18			20			22		
		TH	WF	WPD	TH	WF	WPD	TH	WF	WPD	TH	WF	WPD
°C	°C	kW	m³/h	kPa	kW	m³/h	kPa	kW	m³/h	kPa	kW	m³/h	kPa
40	8	3.38	0.36	3.33	2.94	0.32	2.63	2.51	0.27	2.01	2.08	0.22	1.46
	10	2.94	0.25	1.82	2.50	0.22	1.36	2.08	0.18	0.88	1.67	0.14	0.49
	12	2.51	0.18	0.87	2.09	0.15	0.54	1.68	0.12	0.34	1.27	0.09	0.25
	14	2.11	0.13	0.38	1.69	0.10	0.29	1.27	0.08	0.22	0.85	0.05	0.15
	16	1.70	0.09	0.27	1.28	0.07	0.20	0.86	0.05	0.14	0.43	0.02	0.07
45	8	4.46	0.48	5.22	4.02	0.43	4.36	3.58	0.39	3.58	3.15	0.34	2.87
	10	4.03	0.35	3.02	3.59	0.31	2.48	3.15	0.27	1.99	2.72	0.23	1.55
	12	3.60	0.26	1.84	3.16	0.23	1.48	2.72	0.20	1.11	2.29	0.17	0.73
	14	3.15	0.19	1.08	2.72	0.17	0.75	2.31	0.14	0.48	1.90	0.12	0.31
	16	2.74	0.15	0.53	2.33	0.13	0.36	1.91	0.10	0.27	1.49	0.08	0.21
50	8	5.53	0.60	7.40	5.08	0.55	6.40	4.64	0.50	5.47	4.21	0.45	4.62
	10	5.11	0.44	4.44	4.67	0.40	3.80	4.23	0.37	3.21	3.79	0.33	2.66
	12	4.69	0.34	2.81	4.24	0.31	2.37	3.80	0.27	1.97	3.37	0.24	1.60
	14	4.25	0.26	1.85	3.81	0.23	1.53	3.37	0.21	1.24	2.93	0.18	0.95
	16	3.81	0.21	1.23	3.37	0.18	0.95	2.94	0.16	0.68	2.53	0.14	0.45
55	8	6.60	0.71	9.86	6.15	0.66	8.72	5.71	0.62	7.66	5.27	0.57	6.66
	10	6.19	0.53	6.04	5.74	0.50	5.30	5.30	0.46	4.62	4.86	0.42	3.98
	12	5.77	0.41	3.91	5.32	0.38	3.41	4.88	0.35	2.94	4.44	0.32	2.50
	14	5.35	0.33	2.66	4.90	0.30	2.30	4.46	0.28	1.95	4.02	0.25	1.64
	16	4.91	0.26	1.85	4.46	0.24	1.57	4.02	0.22	1.31	3.58	0.19	1.08
60	8	7.68	0.83	12.60	7.23	0.78	11.32	6.77	0.73	10.14	6.33	0.68	9.04
	10	7.26	0.63	7.79	6.81	0.59	6.96	6.36	0.55	6.19	5.92	0.51	5.46
	12	6.85	0.49	5.17	6.40	0.46	4.60	5.95	0.43	4.06	5.51	0.40	3.54
	14	6.43	0.40	3.56	5.98	0.37	3.15	5.54	0.34	2.75	5.09	0.31	2.39
	16	6.01	0.32	2.54	5.56	0.30	2.22	5.11	0.28	1.93	4.67	0.25	1.65

Heating capacity

MDVF-500D3E													
EWT	ΔT	Indoor temperature (W.B.)											
		16			18			20			22		
		TH	WF	WPD	TH	WF	WPD	TH	WF	WPD	TH	WF	WPD
°C	°C	kW	m ³ /h	kPa	kW	m ³ /h	kPa	kW	m ³ /h	kPa	kW	m ³ /h	kPa
40	8	3.91	0.42	4.26	3.40	0.37	3.37	2.91	0.31	2.57	2.41	0.26	1.87
	10	3.40	0.29	2.32	2.89	0.25	1.77	2.39	0.21	1.23	1.91	0.17	0.71
	12	2.88	0.21	1.24	2.39	0.17	0.77	1.93	0.14	0.44	1.46	0.11	0.29
	14	2.41	0.15	0.51	1.94	0.12	0.34	1.46	0.09	0.25	0.98	0.06	0.17
	16	1.95	0.11	0.31	1.47	0.08	0.23	0.99	0.05	0.16	0.50	0.03	0.08
45	8	5.15	0.56	6.70	4.65	0.50	5.61	4.15	0.45	4.61	3.65	0.39	3.70
	10	4.67	0.40	3.87	4.16	0.36	3.18	3.66	0.32	2.55	3.16	0.27	1.99
	12	4.17	0.30	2.36	3.66	0.26	1.89	3.15	0.23	1.47	2.64	0.19	1.05
	14	3.64	0.22	1.45	3.13	0.19	1.07	2.64	0.16	0.70	2.18	0.13	0.42
	16	3.14	0.17	0.76	2.67	0.14	0.49	2.20	0.12	0.32	1.72	0.09	0.24
50	8	6.40	0.69	9.53	5.89	0.63	8.25	5.38	0.58	7.06	4.88	0.53	5.96
	10	5.92	0.51	5.71	5.41	0.47	4.89	4.90	0.42	4.13	4.40	0.38	3.43
	12	5.43	0.39	3.61	4.92	0.35	3.05	4.42	0.32	2.53	3.91	0.28	2.06
	14	4.93	0.30	2.37	4.42	0.27	1.97	3.91	0.24	1.60	3.40	0.21	1.26
	16	4.42	0.24	1.58	3.91	0.21	1.28	3.39	0.18	0.97	2.90	0.16	0.66
55	8	7.64	0.82	12.72	7.13	0.77	11.26	6.61	0.71	9.90	6.11	0.66	8.62
	10	7.17	0.62	7.79	6.66	0.58	6.85	6.15	0.53	5.97	5.64	0.49	5.14
	12	6.69	0.48	5.04	6.17	0.44	4.39	5.67	0.41	3.79	5.16	0.37	3.23
	14	6.21	0.38	3.43	5.69	0.35	2.96	5.18	0.32	2.52	4.68	0.29	2.12
	16	5.70	0.31	2.37	5.19	0.28	2.02	4.68	0.25	1.70	4.17	0.22	1.39
60	8	8.89	0.96	16.36	8.37	0.90	14.73	7.85	0.85	13.10	7.35	0.79	11.65
	10	8.41	0.73	10.06	7.90	0.68	9.00	7.38	0.64	8.01	6.87	0.59	7.07
	12	7.94	0.57	6.68	7.43	0.53	5.94	6.91	0.50	5.25	6.41	0.46	4.60
	14	7.46	0.46	4.60	6.95	0.43	4.06	6.43	0.40	3.56	5.93	0.37	3.09
	16	6.98	0.38	3.27	6.46	0.35	2.87	5.95	0.32	2.49	5.44	0.29	2.14

Heating capacity

MDVF-600D3E													
EWT	ΔT	Indoor temperature (W.B.)											
		16			18			20			22		
		TH	WF	WPD	TH	WF	WPD	TH	WF	WPD	TH	WF	WPD
°C	°C	kW	m³/h	kPa	kW	m³/h	kPa	kW	m³/h	kPa	kW	m³/h	kPa
40	8	5.01	0.54	8.53	4.37	0.47	6.72	3.74	0.40	5.15	3.12	0.34	3.77
	10	4.40	0.38	4.68	3.77	0.32	3.59	3.13	0.27	2.62	2.50	0.22	1.76
	12	3.78	0.27	2.68	3.14	0.23	1.93	2.51	0.18	1.13	1.91	0.14	0.55
	14	3.15	0.19	1.33	2.54	0.16	0.75	1.92	0.12	0.44	1.30	0.08	0.30
	16	2.57	0.14	0.57	1.94	0.10	0.40	1.31	0.07	0.27	0.67	0.04	0.14
45	8	6.56	0.71	13.23	5.92	0.64	11.08	5.29	0.57	9.11	4.66	0.50	7.32
	10	5.97	0.52	7.69	5.33	0.46	6.33	4.70	0.41	5.09	4.07	0.35	3.98
	12	5.37	0.39	4.73	4.73	0.34	3.81	4.09	0.29	2.98	3.46	0.25	2.24
	14	4.75	0.29	2.97	4.10	0.25	2.32	3.46	0.21	1.72	2.83	0.17	1.08
	16	4.12	0.22	1.86	3.47	0.19	1.27	2.86	0.15	0.76	2.25	0.12	0.44
50	8	8.12	0.88	18.75	7.47	0.81	16.23	6.83	0.74	13.89	6.20	0.67	11.72
	10	7.53	0.65	11.27	6.89	0.60	9.65	6.25	0.54	8.16	5.62	0.49	6.78
	12	6.94	0.50	7.15	6.29	0.45	6.05	5.65	0.41	5.03	5.02	0.36	4.10
	14	6.34	0.39	4.73	5.69	0.35	3.93	5.05	0.31	3.21	4.41	0.27	2.55
	16	5.73	0.31	3.20	5.08	0.27	2.61	4.43	0.24	2.07	3.79	0.20	1.58
55	8	9.67	1.04	24.99	9.02	0.98	22.23	8.38	0.91	19.52	7.74	0.84	16.98
	10	9.09	0.78	15.26	8.44	0.73	13.40	7.80	0.67	11.73	7.16	0.62	10.11
	12	8.50	0.61	9.94	7.85	0.56	8.66	7.21	0.52	7.47	6.57	0.47	6.37
	14	7.92	0.49	6.79	7.27	0.45	5.86	6.62	0.41	4.99	5.98	0.37	4.19
	16	7.31	0.39	4.72	6.66	0.36	4.02	6.01	0.32	3.38	5.37	0.29	2.79
60	8	11.24	1.21	32.10	10.58	1.14	28.79	9.92	1.07	25.67	9.29	1.00	22.81
	10	10.66	0.92	19.83	10.00	0.86	17.74	9.35	0.81	15.77	8.71	0.75	13.92
	12	10.07	0.72	13.13	9.42	0.68	11.67	8.77	0.63	10.31	8.12	0.58	9.03
	14	9.48	0.58	9.06	8.83	0.54	8.00	8.18	0.50	7.01	7.53	0.46	6.08
	16	8.89	0.48	6.48	8.24	0.44	5.68	7.59	0.41	4.93	6.94	0.37	4.24

Heating capacity

MDVF-800D3E													
EWT	ΔT	Indoor temperature (W.B.)											
		16			18			20			22		
		TH	WF	WPD	TH	WF	WPD	TH	WF	WPD	TH	WF	WPD
$^{\circ}\text{C}$	$^{\circ}\text{C}$	kW	m^3/h	kPa	kW	m^3/h	kPa	kW	m^3/h	kPa	kW	m^3/h	kPa
40	8	7.18	0.78	9.61	6.26	0.68	7.55	5.35	0.58	5.77	4.45	0.48	4.20
	10	6.31	0.54	5.26	5.39	0.47	4.02	4.48	0.39	2.94	3.57	0.31	2.00
	12	5.42	0.39	3.02	4.50	0.32	2.20	3.59	0.26	1.34	2.70	0.19	0.62
	14	4.52	0.28	1.58	3.62	0.22	0.87	2.72	0.17	0.47	1.82	0.11	0.31
	16	3.65	0.20	0.63	2.74	0.15	0.43	1.83	0.10	0.29	0.92	0.05	0.15
45	8	9.42	1.02	14.99	8.49	0.92	12.45	7.57	0.82	10.20	6.66	0.72	8.18
	10	8.55	0.74	8.63	7.62	0.66	7.08	6.70	0.58	5.68	5.79	0.50	4.42
	12	7.68	0.55	5.30	6.75	0.49	4.25	5.83	0.42	3.31	4.92	0.35	2.48
	14	6.79	0.42	3.32	5.86	0.36	2.59	4.94	0.30	1.94	4.03	0.25	1.25
	16	5.89	0.32	2.11	4.97	0.27	1.48	4.06	0.22	0.88	3.16	0.17	0.47
50	8	11.66	1.26	21.25	10.71	1.15	18.24	9.78	1.05	15.57	8.86	0.96	13.11
	10	10.78	0.93	12.66	9.85	0.85	10.81	8.92	0.77	9.11	8.00	0.69	7.55
	12	9.91	0.71	8.00	8.98	0.65	6.75	8.05	0.58	5.60	7.14	0.51	4.55
	14	9.04	0.56	5.28	8.11	0.50	4.38	7.18	0.44	3.56	6.26	0.39	2.82
	16	8.16	0.44	3.56	7.23	0.39	2.90	6.30	0.34	2.30	5.38	0.29	1.76
55	8	13.88	1.49	28.16	12.92	1.39	24.85	11.99	1.30	21.89	11.06	1.19	19.01
	10	13.02	1.12	17.14	12.07	1.04	15.02	11.13	0.96	13.08	10.21	0.88	11.26
	12	12.15	0.87	11.14	11.21	0.81	9.68	10.27	0.74	8.32	9.35	0.67	7.07
	14	11.29	0.70	7.57	10.34	0.64	6.51	9.41	0.58	5.54	8.49	0.52	4.63
	16	10.40	0.56	5.25	9.46	0.51	4.46	8.53	0.46	3.74	7.61	0.41	3.08
60	8	16.11	1.74	36.07	15.16	1.64	32.46	14.21	1.53	28.89	13.26	1.43	25.54
	10	15.26	1.32	22.28	14.30	1.23	19.88	13.35	1.15	17.63	12.42	1.07	15.52
	12	14.39	1.04	14.70	13.44	0.97	13.04	12.49	0.90	11.48	11.56	0.83	10.03
	14	13.53	0.83	10.12	12.57	0.77	8.91	11.63	0.72	7.78	10.70	0.66	6.74
	16	12.66	0.68	7.22	11.70	0.63	6.30	10.76	0.58	5.46	9.83	0.53	4.67

Heating capacity

MDVF-1000D3E													
EWT	ΔT	Indoor temperature (W.B.)											
		16			18			20			22		
		TH	WF	WPD	TH	WF	WPD	TH	WF	WPD	TH	WF	WPD
°C	°C	kW	m³/h	kPa	kW	m³/h	kPa	kW	m³/h	kPa	kW	m³/h	kPa
40	8	7.56	0.81	6.15	6.59	0.71	4.87	5.64	0.61	3.73	4.69	0.51	2.72
	10	6.62	0.57	3.37	5.65	0.49	2.58	4.68	0.40	1.88	3.72	0.32	1.18
	12	5.64	0.41	1.91	4.67	0.34	1.30	3.76	0.27	0.74	2.87	0.21	0.39
	14	4.70	0.29	0.86	3.81	0.23	0.50	2.88	0.18	0.34	1.95	0.12	0.23
	16	3.84	0.21	0.41	2.90	0.16	0.31	1.96	0.11	0.21	1.01	0.05	0.11
45	8	9.94	1.07	9.62	8.97	0.97	8.06	8.01	0.86	6.63	7.06	0.76	5.33
	10	9.02	0.78	5.58	8.05	0.69	4.59	7.09	0.61	3.69	6.13	0.53	2.88
	12	8.09	0.58	3.42	7.12	0.51	2.75	6.15	0.44	2.15	5.18	0.37	1.61
	14	7.12	0.44	2.13	6.14	0.38	1.66	5.16	0.32	1.17	4.25	0.26	0.70
	16	6.13	0.33	1.26	5.20	0.28	0.83	4.31	0.23	0.50	3.39	0.18	0.33
50	8	12.31	1.33	13.67	11.33	1.22	11.83	10.37	1.12	10.13	9.41	1.01	8.56
	10	11.41	0.99	8.21	10.44	0.90	7.03	9.47	0.82	5.95	8.51	0.74	4.95
	12	10.49	0.75	5.20	9.52	0.68	4.39	8.53	0.62	3.66	7.59	0.55	2.98
	14	9.57	0.59	3.43	8.59	0.53	2.85	7.62	0.47	2.32	6.65	0.41	1.84
	16	8.62	0.47	2.31	7.64	0.41	1.88	6.65	0.36	1.49	5.67	0.31	1.09
55	8	14.69	1.59	18.33	13.71	1.48	16.23	12.73	1.38	14.26	11.75	1.27	12.35
	10	13.80	1.19	11.18	12.82	1.11	9.83	11.84	1.02	8.56	10.88	0.94	7.39
	12	12.89	0.93	7.25	11.91	0.86	6.32	10.93	0.79	5.45	9.96	0.72	4.65
	14	11.99	0.74	4.94	11.01	0.68	4.26	10.03	0.62	3.64	9.06	0.56	3.06
	16	11.05	0.60	3.43	10.07	0.54	2.92	9.09	0.49	2.46	8.12	0.44	2.03
60	8	17.09	1.84	23.33	16.08	1.73	20.99	15.08	1.63	18.77	14.12	1.52	16.78
	10	16.19	1.40	14.48	15.19	1.31	12.91	14.20	1.22	11.48	13.22	1.14	10.14
	12	15.29	1.10	9.58	14.30	1.03	8.53	13.32	0.96	7.53	12.34	0.89	6.60
	14	14.38	0.89	6.61	13.39	0.83	5.84	12.41	0.76	5.12	11.44	0.70	4.45
	16	13.48	0.73	4.73	12.49	0.67	4.14	11.51	0.62	3.60	10.52	0.57	3.08

Heating capacity

MDVF-1200D3E													
EWT	ΔT	Indoor temperature (W.B.)											
		16			18			20			22		
		TH	WF	WPD	TH	WF	WPD	TH	WF	WPD	TH	WF	WPD
$^{\circ}\text{C}$	$^{\circ}\text{C}$	kW	m ³ /h	kPa	kW	m ³ /h	kPa	kW	m ³ /h	kPa	kW	m ³ /h	kPa
40	8	9.08	0.98	6.23	7.92	0.85	4.93	6.78	0.73	3.78	5.63	0.61	2.75
	10	7.95	0.69	3.41	6.78	0.59	2.61	5.61	0.48	1.90	4.46	0.38	1.19
	12	6.76	0.49	1.93	5.60	0.40	1.31	4.51	0.32	0.74	3.45	0.25	0.40
	14	5.62	0.35	0.87	4.57	0.28	0.50	3.46	0.21	0.34	2.34	0.14	0.23
	16	4.61	0.25	0.42	3.49	0.19	0.31	2.36	0.13	0.21	1.21	0.07	0.11
45	8	11.95	1.29	9.76	10.78	1.16	8.18	9.63	1.04	6.73	8.49	0.92	5.41
	10	10.84	0.94	5.66	9.68	0.84	4.66	8.53	0.74	3.75	7.37	0.64	2.92
	12	9.72	0.70	3.47	8.54	0.62	2.79	7.39	0.53	2.17	6.22	0.45	1.62
	14	8.55	0.53	2.16	7.36	0.45	1.67	6.19	0.38	1.18	5.09	0.31	0.71
	16	7.35	0.40	1.27	6.23	0.34	0.84	5.17	0.28	0.51	4.07	0.22	0.33
50	8	14.81	1.60	13.87	13.64	1.47	12.02	12.47	1.35	10.30	11.32	1.22	8.70
	10	13.73	1.19	8.33	12.56	1.09	7.14	11.40	0.99	6.04	10.24	0.89	5.03
	12	12.62	0.91	5.27	11.45	0.82	4.46	10.28	0.74	3.71	9.13	0.66	3.03
	14	11.50	0.71	3.48	10.33	0.64	2.89	9.16	0.56	2.36	7.99	0.49	1.87
	16	10.36	0.56	2.34	9.17	0.50	1.90	7.99	0.43	1.51	6.81	0.37	1.10
55	8	17.68	1.91	18.62	16.49	1.78	16.50	15.32	1.66	14.50	14.14	1.53	12.56
	10	16.61	1.43	11.35	15.43	1.33	9.99	14.25	1.23	8.71	13.09	1.13	7.51
	12	15.51	1.11	7.36	14.33	1.03	6.42	13.16	0.95	5.54	12.00	0.86	4.73
	14	14.42	0.89	5.02	13.24	0.82	4.33	12.07	0.75	3.70	10.91	0.67	3.11
	16	13.29	0.72	3.48	12.11	0.65	2.97	10.94	0.59	2.49	9.77	0.53	2.06
60	8	20.53	2.21	23.70	19.34	2.08	21.33	18.16	1.96	19.09	16.98	1.84	17.07
	10	19.47	1.68	14.72	18.26	1.58	13.12	17.10	1.47	11.68	15.93	1.37	10.32
	12	18.40	1.32	9.74	17.21	1.24	8.67	16.04	1.15	7.66	14.87	1.07	6.72
	14	17.31	1.07	6.71	16.12	0.99	5.94	14.95	0.92	5.21	13.78	0.85	4.53
	16	16.22	0.88	4.80	15.03	0.81	4.21	13.86	0.75	3.66	12.68	0.68	3.14

Heating capacity

MDVF-1400D3E													
EWT	ΔT	Indoor temperature (W.B.)											
		16			18			20			22		
		TH	WF	WPD	TH	WF	WPD	TH	WF	WPD	TH	WF	WPD
°C	°C	kW	m³/h	kPa	kW	m³/h	kPa	kW	m³/h	kPa	kW	m³/h	kPa
40	8	12.51	1.35	12.01	10.93	1.18	9.51	9.35	1.01	7.24	7.80	0.84	5.30
	10	11.02	0.95	6.59	9.43	0.81	5.05	7.86	0.68	3.70	6.29	0.54	2.53
	12	9.50	0.68	3.79	7.91	0.57	2.78	6.31	0.45	1.87	4.76	0.34	0.94
	14	7.92	0.49	2.15	6.34	0.39	1.29	4.82	0.30	0.62	3.25	0.20	0.36
	16	6.42	0.35	0.92	4.87	0.26	0.50	3.28	0.18	0.33	1.67	0.09	0.17
45	8	16.37	1.77	18.63	14.78	1.59	15.58	13.20	1.42	12.81	11.63	1.25	10.29
	10	14.91	1.29	10.82	13.31	1.15	8.90	11.73	1.01	7.15	10.17	0.88	5.59
	12	13.42	0.97	6.66	11.83	0.85	5.36	10.24	0.74	4.19	8.66	0.62	3.15
	14	11.91	0.73	4.18	10.30	0.63	3.27	8.71	0.54	2.46	7.11	0.44	1.74
	16	10.36	0.56	2.66	8.74	0.47	2.00	7.15	0.39	1.30	5.61	0.30	0.68
50	8	20.24	2.19	26.55	18.64	2.01	22.97	17.03	1.84	19.54	15.45	1.67	16.48
	10	18.79	1.62	15.86	17.18	1.49	13.58	15.59	1.35	11.46	14.01	1.21	9.53
	12	17.31	1.24	10.05	15.71	1.13	8.49	14.11	1.01	7.06	12.53	0.90	5.76
	14	15.83	0.98	6.64	14.22	0.88	5.53	12.62	0.78	4.51	11.04	0.68	3.58
	16	14.32	0.77	4.48	12.72	0.69	3.67	11.11	0.60	2.92	9.52	0.51	2.24
55	8	24.12	2.60	35.35	22.48	2.42	31.17	20.86	2.25	27.34	19.25	2.08	23.76
	10	22.66	1.95	21.49	21.04	1.81	18.87	19.43	1.68	16.42	17.84	1.54	14.14
	12	21.21	1.53	14.04	19.57	1.41	12.18	17.97	1.29	10.49	16.38	1.18	8.94
	14	19.74	1.22	9.54	18.12	1.12	8.22	16.52	1.02	7.01	14.92	0.92	5.88
	16	18.25	0.99	6.65	16.63	0.90	5.67	15.01	0.81	4.74	13.42	0.72	3.91
60	8	27.99	3.01	45.04	26.32	2.83	40.46	24.70	2.66	36.24	23.10	2.49	32.29
	10	26.55	2.29	27.96	24.91	2.15	24.99	23.28	2.01	22.19	21.66	1.87	19.57
	12	25.08	1.80	18.41	23.46	1.69	16.42	21.84	1.57	14.49	20.23	1.46	12.68
	14	23.63	1.46	12.74	21.99	1.35	11.24	20.38	1.25	9.84	18.77	1.16	8.54
	16	22.16	1.20	9.11	20.53	1.11	7.97	18.91	1.02	6.92	17.31	0.93	5.94

3-row Duct 30Pa Cooling capacity

EWT: Enter Water Temp. (°C) **Δt:** Temperature Difference (°C) **DB:** Dry Bulb Temp. (°C) **WB:** Wet Bulb Temp. (°C)

TC: Total Cooling Capacity (kW) **SC:** Sensible Cooling Capacity (kW) **WF:** Water Flow (m³/h) **WPD:** Water Pressure Drop (kPa)

MDVF-200D303E																						
EWT	ΔT	Indoor temp (W.B.)	Indoor temperature (D.B.)																			
			21				23				25				27				29			
°C	°C	°C	TC	SC	WF	WPD	TC	SC	WF	WPD	TC	SC	WF	WPD	TC	SC	WF	WPD	TC	SC	WF	WPD
5	3	15	1.98	1.58	0.56	18.51	1.96	1.82	0.56	18.19	2.06	2.06	0.59	20.14	2.30	2.30	0.66	24.31	2.53	2.53	0.72	28.35
		17	2.69	1.58	0.77	31.59	2.67	1.82	0.76	31.23	2.66	2.06	0.76	30.86	2.64	2.30	0.75	30.47	2.61	2.53	0.75	30.03
		19	-	-	-	-	3.45	1.83	0.99	49.19	3.43	2.07	0.99	48.67	3.40	2.31	0.98	48.14	3.38	2.54	0.98	47.61
		20	-	-	-	-	3.85	1.83	1.10	58.91	3.82	2.07	1.10	58.29	3.80	2.31	1.09	57.66	3.78	2.55	1.08	57.04
	4	15	1.66	1.43	0.36	8.42	1.67	1.67	0.36	8.56	1.92	1.92	0.41	10.69	2.16	2.16	0.46	13.06	2.39	2.39	0.51	15.61
		17	2.38	1.44	0.51	15.47	2.36	1.68	0.51	15.28	2.35	1.92	0.50	15.09	2.32	2.16	0.50	14.85	2.40	2.39	0.51	15.64
		19	-	-	-	-	3.13	1.69	0.67	24.79	3.11	1.93	0.67	24.51	3.09	2.17	0.66	24.24	3.07	2.40	0.66	23.97
		20	-	-	-	-	3.54	1.69	0.76	30.65	3.52	1.93	0.75	30.32	3.49	2.17	0.75	29.98	3.47	2.41	0.74	29.66
	5	15	1.31	1.28	0.23	3.44	1.53	1.53	0.26	4.90	1.77	1.77	0.30	6.37	2.01	2.01	0.35	7.92	2.25	2.25	0.39	9.58
		17	2.05	1.29	0.35	8.14	2.03	1.54	0.35	8.03	2.01	1.78	0.34	7.89	2.02	2.02	0.35	7.95	2.26	2.26	0.39	9.61
		19	-	-	-	-	2.81	1.55	0.48	13.97	2.79	1.79	0.48	13.81	2.77	2.03	0.48	13.65	2.75	2.26	0.47	13.49
		20	-	-	-	-	3.23	1.55	0.56	17.83	3.20	1.79	0.55	17.63	3.18	2.03	0.55	17.43	3.16	2.27	0.54	17.24
6	15	1.17	1.16	0.17	1.56	1.39	1.39	0.20	2.50	1.63	1.63	0.23	3.76	1.87	1.87	0.27	5.08	2.11	2.11	0.30	6.29	
	17	1.69	1.14	0.24	4.10	1.67	1.39	0.24	3.99	1.66	1.63	0.24	3.95	1.87	1.87	0.27	5.10	2.12	2.12	0.30	6.31	
	19	-	-	-	-	2.47	1.40	0.35	8.22	2.46	1.65	0.35	8.12	2.44	1.89	0.35	8.02	2.41	2.12	0.35	7.89	
	20	-	-	-	-	2.89	1.41	0.41	10.69	2.87	1.65	0.41	10.57	2.85	1.89	0.41	10.45	2.83	2.13	0.41	10.33	
7	3	15	1.42	1.33	0.41	10.41	1.58	1.58	0.45	12.42	1.82	1.82	0.53	16.10	2.06	2.06	0.59	19.90	2.29	2.29	0.66	23.66
		17	2.14	1.34	0.61	21.08	2.13	1.58	0.61	20.85	2.12	1.82	0.61	20.87	2.10	2.06	0.61	20.64	2.30	2.30	0.66	23.73
		19	-	-	-	-	2.90	1.59	0.84	36.08	2.88	1.83	0.83	35.68	2.86	2.07	0.83	35.27	2.84	2.30	0.82	34.87
		20	-	-	-	-	3.30	1.59	0.95	44.67	3.28	1.83	0.94	44.18	3.26	2.07	0.94	43.68	3.24	2.30	0.93	43.19
	4	15	1.18	1.18	0.25	4.63	1.43	1.43	0.31	6.48	1.68	1.68	0.36	8.46	1.92	1.92	0.41	10.63	2.16	2.16	0.47	13.04
		17	1.81	1.20	0.39	9.66	1.80	1.44	0.39	9.49	1.78	1.68	0.38	9.35	1.92	1.92	0.41	10.66	2.16	2.16	0.47	13.08
		19	-	-	-	-	2.57	1.44	0.55	17.43	2.55	1.69	0.55	17.22	2.53	1.93	0.54	17.01	2.51	2.16	0.54	16.76
		20	-	-	-	-	2.98	1.45	0.64	22.49	2.96	1.69	0.64	22.23	2.94	1.93	0.63	21.97	2.92	2.17	0.63	21.71
	5	15	1.05	1.05	0.18	1.99	1.29	1.29	0.22	3.38	1.53	1.53	0.26	4.91	1.78	1.78	0.31	6.32	2.02	2.02	0.35	7.84
		17	1.44	1.04	0.25	4.39	1.42	1.29	0.24	4.28	1.53	1.53	0.26	4.92	1.78	1.78	0.31	6.34	2.02	2.02	0.35	7.86
		19	-	-	-	-	2.23	1.30	0.38	9.27	2.21	1.55	0.38	9.15	2.21	1.82	0.40	21.42	2.17	2.03	0.37	8.87
		20	-	-	-	-	2.64	1.31	0.45	12.38	2.62	1.55	0.45	12.23	2.60	1.79	0.45	12.08	2.58	2.03	0.44	11.93
6	15	0.94	0.94	0.13	1.00	1.17	1.17	0.17	1.63	1.39	1.39	0.20	2.65	1.63	1.63	0.23	3.92	1.87	1.87	0.27	5.05	
	17	1.13	0.92	0.16	1.50	1.17	1.17	0.17	1.66	1.40	1.40	0.20	2.67	1.64	1.64	0.24	3.93	1.88	1.88	0.27	5.07	
	19	-	-	-	-	1.85	1.16	0.27	4.94	1.83	1.40	0.26	4.85	1.81	1.64	0.26	4.76	1.88	1.87	0.27	5.06	
	20	-	-	-	-	2.28	1.17	0.33	7.02	2.26	1.41	0.32	6.93	2.24	1.65	0.32	6.83	2.22	1.89	0.32	6.71	
9	3	15	1.09	1.09	0.31	6.49	1.33	1.33	0.38	9.19	1.57	1.57	0.45	12.23	1.82	1.82	0.52	15.71	2.05	2.05	0.59	19.28
		17	1.56	1.09	0.45	11.98	1.54	1.33	0.44	11.73	1.57	1.56	0.45	12.20	1.82	1.82	0.52	15.76	2.06	2.06	0.59	19.34
		19	-	-	-	-	2.31	1.34	0.66	23.71	2.30	1.58	0.66	23.42	2.28	1.82	0.65	23.09	2.26	2.06	0.65	22.70
		20	-	-	-	-	2.72	1.34	0.79	31.92	2.71	1.59	0.78	31.56	2.69	1.83	0.78	31.18	2.67	2.07	0.77	30.80
	4	15	0.94	0.94	0.20	2.80	1.19	1.19	0.26	4.60	1.43	1.43	0.31	6.35	1.68	1.68	0.36	8.29	1.92	1.92	0.41	10.40
		17	1.18	0.94	0.25	4.53	1.19	1.19	0.26	4.65	1.44	1.44	0.31	6.37	1.68	1.68	0.36	8.31	1.92	1.92	0.41	10.44
		19	-	-	-	-	1.96	1.20	0.42	10.85	1.95	1.44	0.42	10.68	1.93	1.68	0.41	10.48	1.94	1.93	0.42	10.60
		20	-	-	-	-	2.37	1.20	0.51	15.01	2.36	1.45	0.51	14.82	2.34	1.69	0.50	14.62	2.32	1.93	0.50	14.39
	5	15	0.82	0.82	0.14	1.08	1.05	1.05	0.18	2.06	1.29	1.29	0.22	3.49	1.54	1.54	0.26	4.86	1.78	1.78	0.31	6.23
		17	0.87	0.82	0.15	1.23	1.05	1.05	0.18	2.07	1.29	1.29	0.22	3.50	1.54	1.54	0.26	4.88	1.78	1.78	0.31	6.25
		19	-	-	-	-	1.58	1.06	0.27	5.12	1.56	1.30	0.27	5.01	1.57	1.54	0.27	5.04	1.79	1.79	0.31	6.27
		20	-	-	-	-	2.01	1.06	0.35	7.65	1.99	1.31	0.34	7.54	1.97	1.55	0.34	7.41	1.95	1.79	0.34	7.29
6	15	0.70	0.70	0.10	0.68	0.94	0.94	0.13	0.98	1.16	1.16	0.17	1.68	1.39	1.39	0.20	2.73	1.64	1.64	0.23	3.92	
	17	0.70	0.70	0.10	0.68	0.94	0.94	0.13	0.98	1.17	1.17	0.17	1.69	1.40	1.40	0.20	2.75	1.64	1.64	0.24	3.94	
	19	-	-	-	-	1.20	0.92	0.17	1.85	1.21	1.17	0.17	1.87	1.40	1.40	0.20	2.76	1.64	1.64	0.24	3.95	
	20	-	-	-	-	1.60	0.91	0.23	3.76	1.58	1.16	0.23	3.67	1.57	1.40	0.22	3.59	1.64	1.63	0.24	3.94	

Continued:

MDVF-200D303E																						
EWT	ΔT	Indoor temp (W.B.)	Indoor temperature (D.B.)																			
			21				23				25				27				29			
			TC	SC	WF	WPD	TC	SC	WF	WPD	TC	SC	WF	WPD	TC	SC	WF	WPD	TC	SC	WF	WPD
°C	°C	°C	kW	kW	m³/h	kPa	kW	kW	m³/h	kPa	kW	kW	m³/h	kPa	kW	kW	m³/h	kPa	kW	kW	m³/h	kPa
11	3	15	0.83	0.83	0.24	4.04	1.09	1.09	0.31	6.31	1.33	1.33	0.38	8.93	1.57	1.57	0.45	11.88	1.81	1.81	0.52	15.26
		17	0.91	0.84	0.26	4.65	1.09	1.09	0.31	6.33	1.33	1.33	0.38	8.95	1.58	1.58	0.45	11.92	1.82	1.82	0.52	15.31
		19	-	-	-	-	1.68	1.09	0.48	13.34	1.66	1.34	0.47	13.07	1.65	1.58	0.47	12.93	1.82	1.82	0.52	15.34
		20	-	-	-	-	2.09	1.09	0.60	19.42	2.08	1.34	0.59	19.16	2.06	1.58	0.59	18.85	2.03	1.82	0.58	18.52
	4	15	0.71	0.71	0.15	1.30	0.94	0.94	0.20	2.81	1.19	1.19	0.25	4.52	1.44	1.44	0.31	6.21	1.68	1.68	0.36	8.08
		17	0.71	0.70	0.15	1.30	0.94	0.94	0.20	2.83	1.19	1.19	0.26	4.53	1.44	1.44	0.31	6.23	1.68	1.68	0.36	8.11
		19	-	-	-	-	1.29	0.95	0.28	5.21	1.29	1.20	0.28	5.14	1.44	1.44	0.31	6.24	1.68	1.68	0.36	8.14
		20	-	-	-	-	1.72	0.96	0.37	8.43	1.70	1.20	0.36	8.28	1.68	1.44	0.36	8.12	1.70	1.69	0.36	8.28
	5	15	0.59	0.59	0.10	0.67	0.82	0.82	0.14	1.12	1.05	1.05	0.18	2.16	1.30	1.30	0.22	3.55	1.54	1.54	0.27	4.81
		17	0.59	0.59	0.10	0.67	0.83	0.83	0.14	1.12	1.05	1.05	0.18	2.17	1.30	1.30	0.22	3.56	1.54	1.54	0.27	4.83
		19	-	-	-	-	0.92	0.82	0.16	1.51	1.06	1.05	0.18	2.17	1.30	1.30	0.22	3.58	1.55	1.55	0.27	4.84
		20	-	-	-	-	1.31	0.81	0.23	3.62	1.29	1.06	0.22	3.52	1.32	1.31	0.23	3.65	1.55	1.55	0.27	4.85
6	15	0.47	0.47	0.07	0.43	0.71	0.71	0.10	0.65	0.94	0.94	0.13	0.99	1.16	1.16	0.17	1.76	1.40	1.40	0.20	2.83	
	17	0.47	0.47	0.07	0.43	0.71	0.71	0.10	0.65	0.94	0.94	0.14	1.00	1.17	1.17	0.17	1.76	1.40	1.40	0.20	2.84	
	19	-	-	-	-	0.71	0.71	0.10	0.66	0.94	0.94	0.14	1.00	1.17	1.17	0.17	1.77	1.40	1.40	0.20	2.85	
	20	-	-	-	-	0.96	0.69	0.14	1.04	0.98	0.94	0.14	1.11	1.17	1.17	0.17	1.78	1.41	1.41	0.20	2.86	
13	3	15	0.59	0.59	0.17	1.83	0.84	0.84	0.24	4.07	1.09	1.09	0.31	6.31	1.33	1.33	0.38	8.91	1.57	1.57	0.45	11.84
		17	0.59	0.59	0.17	1.84	0.84	0.84	0.24	4.08	1.09	1.09	0.31	6.33	1.33	1.33	0.38	8.94	1.57	1.57	0.45	11.88
		19	-	-	-	-	1.00	0.84	0.29	5.43	1.09	1.07	0.31	6.30	1.34	1.34	0.38	8.97	1.58	1.58	0.45	11.92
		20	-	-	-	-	1.41	0.85	0.41	9.88	1.40	1.09	0.40	9.66	1.39	1.34	0.40	9.64	1.58	1.58	0.45	11.94
	4	15	0.47	0.47	0.10	0.65	0.71	0.71	0.15	1.38	0.94	0.94	0.20	2.94	1.19	1.19	0.26	4.51	1.43	1.43	0.31	6.11
		17	0.48	0.48	0.10	0.65	0.71	0.71	0.15	1.38	0.95	0.95	0.20	2.95	1.20	1.20	0.26	4.52	1.44	1.44	0.31	6.12
		19	-	-	-	-	0.71	0.70	0.15	1.38	0.95	0.95	0.20	2.96	1.20	1.20	0.26	4.54	1.44	1.44	0.31	6.14
		20	-	-	-	-	0.99	0.70	0.21	3.22	0.99	0.95	0.21	3.26	1.20	1.20	0.26	4.54	1.44	1.44	0.31	6.16
	5	15	0.35	0.35	0.06	0.37	0.59	0.59	0.10	0.63	0.82	0.82	0.14	1.13	1.05	1.05	0.18	2.21	1.30	1.30	0.22	3.51
		17	0.35	0.35	0.06	0.38	0.59	0.59	0.10	0.63	0.82	0.82	0.14	1.14	1.05	1.05	0.18	2.22	1.30	1.30	0.22	3.52
		19	-	-	-	-	0.59	0.59	0.10	0.63	0.82	0.82	0.14	1.14	1.06	1.06	0.18	2.23	1.30	1.30	0.22	3.53
		20	-	-	-	-	0.65	0.59	0.11	0.70	0.82	0.82	0.14	1.14	1.06	1.06	0.18	2.24	1.30	1.30	0.22	3.54
6	15	0.24	0.24	0.03	0.20	0.47	0.47	0.07	0.41	0.71	0.71	0.10	0.62	0.94	0.94	0.13	1.01	1.16	1.16	0.17	1.80	
	17	0.24	0.24	0.03	0.20	0.47	0.47	0.07	0.41	0.71	0.71	0.10	0.62	0.94	0.94	0.13	1.01	1.17	1.17	0.17	1.81	
	19	-	-	-	-	0.47	0.47	0.07	0.41	0.71	0.71	0.10	0.62	0.94	0.94	0.13	1.01	1.17	1.17	0.17	1.82	
	20	-	-	-	-	0.47	0.47	0.07	0.41	0.71	0.71	0.10	0.62	0.94	0.94	0.13	1.02	1.17	1.17	0.17	1.83	
15	3	15	0.36	0.36	0.10	0.62	0.59	0.59	0.17	1.85	0.84	0.84	0.24	3.95	1.09	1.09	0.31	6.12	1.33	1.33	0.38	8.64
		17	0.36	0.36	0.10	0.62	0.59	0.59	0.17	1.86	0.84	0.84	0.24	3.96	1.09	1.09	0.31	6.14	1.33	1.33	0.38	8.67
		19	-	-	-	-	0.59	0.59	0.17	1.87	0.84	0.84	0.24	3.98	1.09	1.09	0.31	6.16	1.33	1.33	0.38	8.70
		20	-	-	-	-	0.65	0.59	0.19	2.43	0.84	0.83	0.24	3.97	1.09	1.09	0.31	6.17	1.33	1.33	0.38	8.71
	4	15	0.24	0.24	0.05	0.30	0.47	0.47	0.10	0.61	0.71	0.71	0.15	1.41	0.95	0.95	0.20	2.94	1.19	1.19	0.26	4.40
		17	0.24	0.24	0.05	0.30	0.48	0.48	0.10	0.61	0.71	0.71	0.15	1.41	0.95	0.95	0.20	2.95	1.20	1.20	0.26	4.42
		19	-	-	-	-	0.48	0.48	0.10	0.61	0.71	0.71	0.15	1.42	0.95	0.95	0.20	2.96	1.20	1.20	0.26	4.43
		20	-	-	-	-	0.47	0.46	0.10	0.61	0.71	0.71	0.15	1.42	0.95	0.95	0.20	2.97	1.20	1.20	0.26	4.44
	5	15	0.12	0.12	0.02	0.12	0.36	0.36	0.06	0.36	0.59	0.59	0.10	0.61	0.82	0.82	0.14	1.20	1.06	1.06	0.18	2.32
		17	0.12	0.12	0.02	0.12	0.36	0.36	0.06	0.36	0.59	0.59	0.10	0.61	0.82	0.82	0.14	1.20	1.06	1.06	0.18	2.33
		19	-	-	-	-	0.36	0.36	0.06	0.36	0.60	0.60	0.10	0.61	0.83	0.83	0.14	1.21	1.06	1.06	0.18	2.34
		20	-	-	-	-	0.36	0.36	0.06	0.36	0.60	0.60	0.10	0.61	0.83	0.83	0.14	1.21	1.06	1.06	0.18	2.34
6	15	-	-	-	-	0.24	0.24	0.03	0.20	0.47	0.47	0.07	0.39	0.71	0.71	0.10	0.59	0.94	0.94	0.13	1.05	
	17	-	-	-	-	0.24	0.24	0.03	0.20	0.47	0.47	0.07	0.40	0.71	0.71	0.10	0.60	0.94	0.94	0.13	1.06	
	19	-	-	-	-	0.24	0.24	0.03	0.20	0.48	0.48	0.07	0.40	0.71	0.71	0.10	0.60	0.94	0.94	0.14	1.06	
	20	-	-	-	-	0.24	0.24	0.03	0.20	0.48	0.48	0.07	0.40	0.71	0.71	0.10	0.60	0.94	0.94	0.14	1.06	

Cooling capacity

MDVF-300D303E																							
EWT	ΔT	Indoor temp (W.B.)	Indoor temperature (D.B.)																				
			21				23				25				27				29				
			TC	SC	WF	WPD	TC	SC	WF	WPD	TC	SC	WF	WPD	TC	SC	WF	WPD	TC	SC	WF	WPD	
°C	°C	°C	kW	kW	m³/h	kPa	kW	kW	m³/h	kPa	kW	kW	m³/h	kPa	kW	kW	m³/h	kPa	kW	kW	m³/h	kPa	
5	3	15	2.57	2.02	0.73	34.57	2.54	2.32	0.73	34.01	2.62	2.62	0.75	35.89	2.92	2.92	0.84	43.26	3.21	3.21	0.92	51.10	
		17	3.46	2.03	0.99	58.32	3.44	2.33	0.99	57.63	3.42	2.63	0.98	56.95	3.39	2.92	0.97	56.15	3.36	3.22	0.96	55.42	
		19	-	-	-	-	4.41	2.34	1.28	90.36	4.38	2.64	1.26	89.02	4.35	2.94	1.26	88.23	4.32	3.23	1.24	85.92	
		20	-	-	-	-	4.92	2.34	1.42	109.65	4.89	2.64	1.42	108.55	4.86	2.94	1.41	107.38	4.83	3.24	1.40	106.15	
	4	15	2.19	1.85	0.47	16.01	2.21	2.16	0.48	16.35	2.46	2.46	0.53	19.67	2.76	2.76	0.59	23.67	3.05	3.05	0.65	28.20	
		17	3.10	1.86	0.66	28.99	3.08	2.16	0.66	28.63	3.05	2.46	0.65	28.24	3.03	2.76	0.65	27.82	3.07	3.06	0.66	28.51	
		19	-	-	-	-	4.04	2.17	0.87	46.00	4.02	2.47	0.86	45.48	3.99	2.77	0.86	44.95	3.96	3.06	0.85	44.44	
		20	-	-	-	-	4.56	2.18	0.99	57.31	4.53	2.48	0.98	56.66	4.50	2.78	0.97	55.68	4.47	3.07	0.96	55.04	
	5	15	1.81	1.68	0.31	7.85	1.99	1.99	0.34	9.21	2.29	2.29	0.39	11.74	2.59	2.59	0.44	14.48	2.89	2.89	0.50	17.59	
		17	2.73	1.70	0.47	15.95	2.71	2.00	0.47	15.72	2.69	2.30	0.46	15.48	2.69	2.60	0.46	15.51	2.90	2.90	0.50	17.64	
		19	-	-	-	-	3.67	2.00	0.63	26.28	3.65	2.31	0.63	25.98	3.62	2.61	0.62	25.67	3.59	2.90	0.62	25.34	
		20	-	-	-	-	4.19	2.01	0.72	33.29	4.16	2.31	0.72	32.89	4.13	2.61	0.71	32.52	4.11	2.91	0.71	32.15	
	6	15	1.52	1.52	0.22	3.76	1.82	1.82	0.26	5.74	2.13	2.13	0.30	7.57	2.43	2.43	0.35	9.48	2.73	2.73	0.39	11.60	
		17	2.33	1.52	0.33	8.81	2.30	1.83	0.33	8.65	2.29	2.13	0.33	8.59	2.44	2.43	0.35	9.52	2.74	2.74	0.39	11.63	
		19	-	-	-	-	3.29	1.84	0.47	15.95	3.27	2.15	0.47	15.76	3.24	2.45	0.47	15.54	3.21	2.74	0.46	15.31	
		20	-	-	-	-	3.80	1.84	0.54	20.27	3.77	2.15	0.54	20.03	3.75	2.45	0.54	19.79	3.72	2.75	0.53	19.55	
	7	3	15	1.88	1.71	0.54	20.24	2.01	2.01	0.58	22.52	2.32	2.32	0.67	29.13	2.62	2.62	0.76	35.91	2.91	2.91	0.84	42.63
			17	2.78	1.72	0.80	39.92	2.76	2.02	0.80	39.40	2.74	2.32	0.79	38.74	2.72	2.62	0.79	38.41	2.92	2.92	0.84	42.76
			19	-	-	-	-	3.72	2.03	1.08	66.05	3.70	2.33	1.07	64.99	3.67	2.63	1.06	63.99	3.65	2.92	1.05	63.39
			20	-	-	-	-	4.24	2.03	1.23	83.57	4.21	2.34	1.22	82.59	4.17	2.63	1.20	80.31	4.15	2.93	1.19	79.36
4		15	1.55	1.55	0.33	8.83	1.85	1.85	0.40	11.97	2.16	2.16	0.47	15.51	2.45	2.45	0.53	19.17	2.75	2.75	0.59	23.34	
		17	2.39	1.55	0.51	18.30	2.36	1.85	0.51	17.98	2.35	2.16	0.50	17.77	2.46	2.46	0.53	19.26	2.76	2.76	0.59	23.41	
		19	-	-	-	-	3.35	1.87	0.72	33.05	3.32	2.17	0.72	32.65	3.30	2.47	0.71	32.23	3.27	2.76	0.71	31.75	
		20	-	-	-	-	3.86	1.87	0.83	42.31	3.83	2.17	0.83	41.82	3.80	2.47	0.82	41.32	3.78	2.77	0.82	40.82	
5		15	1.37	1.37	0.24	4.68	1.68	1.68	0.29	6.86	1.99	1.99	0.34	9.11	2.29	2.29	0.39	11.58	2.59	2.59	0.45	14.28	
		17	1.98	1.38	0.34	9.02	1.96	1.69	0.34	8.87	2.02	2.00	0.35	9.37	2.30	2.30	0.40	11.62	2.60	2.60	0.45	14.33	
		19	-	-	-	-	2.94	1.70	0.51	17.73	2.92	2.00	0.50	17.49	2.92	2.32	0.53	41.01	2.87	2.60	0.50	17.11	
		20	-	-	-	-	3.45	1.70	0.59	23.40	3.43	2.01	0.59	23.12	3.41	2.31	0.59	22.83	3.38	2.60	0.58	22.51	
6		15	1.22	1.22	0.18	2.19	1.51	1.51	0.22	3.91	1.82	1.82	0.26	5.71	2.13	2.13	0.30	7.44	2.43	2.43	0.35	9.32	
		17	1.54	1.21	0.22	4.07	1.57	1.52	0.23	4.28	1.83	1.82	0.26	5.73	2.13	2.13	0.31	7.47	2.43	2.43	0.35	9.35	
		19	-	-	-	-	2.52	1.53	0.36	9.94	2.50	1.84	0.36	9.77	2.48	2.14	0.36	9.63	2.52	2.44	0.36	9.91	
		20	-	-	-	-	3.05	1.54	0.44	13.84	3.03	1.85	0.44	13.66	3.00	2.15	0.43	13.46	2.98	2.45	0.43	13.25	
9		3	15	1.40	1.40	0.40	11.90	1.71	1.71	0.49	16.83	2.01	2.01	0.58	22.15	2.31	2.31	0.67	28.60	2.61	2.61	0.75	34.75
			17	2.04	1.40	0.58	22.62	2.01	1.71	0.58	22.19	2.04	2.02	0.59	22.72	2.32	2.32	0.67	28.69	2.61	2.61	0.75	34.86
			19	-	-	-	-	2.99	1.72	0.87	44.78	2.97	2.02	0.86	44.19	2.95	2.32	0.85	43.54	2.92	2.62	0.85	42.86
			20	-	-	-	-	3.50	1.72	1.01	58.01	3.47	2.02	1.00	57.29	3.45	2.32	0.99	56.55	3.42	2.62	0.98	55.81
	4	15	1.23	1.23	0.26	5.82	1.54	1.54	0.33	8.54	1.85	1.85	0.40	11.64	2.15	2.15	0.46	15.08	2.45	2.45	0.53	18.95	
		17	1.61	1.24	0.35	9.22	1.63	1.55	0.35	9.33	1.85	1.85	0.40	11.67	2.16	2.16	0.46	15.13	2.46	2.46	0.53	19.01	
		19	-	-	-	-	2.58	1.55	0.56	20.74	2.56	1.86	0.55	20.41	2.53	2.16	0.55	20.08	2.55	2.46	0.55	20.24	
		20	-	-	-	-	3.09	1.55	0.67	28.12	3.07	1.86	0.66	27.93	3.05	2.17	0.66	27.77	3.02	2.46	0.65	27.33	
	5	15	1.07	1.07	0.18	2.56	1.37	1.37	0.24	4.73	1.68	1.68	0.29	6.75	1.99	1.99	0.34	8.96	2.29	2.29	0.39	11.39	
		17	1.17	1.06	0.20	3.32	1.37	1.37	0.24	4.74	1.69	1.69	0.29	6.77	1.99	1.99	0.34	8.99	2.29	2.29	0.39	11.43	
		19	-	-	-	-	2.15	1.39	0.37	10.21	2.13	1.69	0.37	10.02	2.13	2.00	0.37	10.08	2.30	2.30	0.40	11.49	
		20	-	-	-	-	2.67	1.39	0.46	14.90	2.65	1.70	0.46	14.67	2.63	2.00	0.45	14.45	2.61	2.30	0.45	14.29	
	6	15	0.93	0.93	0.13	1.13	1.22	1.22	0.17	2.26	1.52	1.52	0.22	3.98	1.82	1.82	0.26	5.65	2.13	2.13	0.31	7.33	
		17	0.95	0.93	0.14	1.19	1.22	1.22	0.17	2.27	1.52	1.52	0.22	3.99	1.83	1.83	0.26	5.67	2.13	2.13	0.31	7.36	
		19	-	-	-	-	1.68	1.21	0.24	4.88	1.68	1.52	0.24	4.89	1.84	1.84	0.26	5.74	2.14	2.14	0.31	7.38	
		20	-	-	-	-	2.22	1.22	0.32	7.87	2.19	1.53	0.31	7.72	2.18	1.84	0.31	7.61	2.23	2.14	0.32	7.92	

Continued:

MDVF-300D303E																						
EWT	ΔT	Indoor temp (W.B.)	Indoor temperature (D.B.)																			
			21				23				25				27				29			
			TC	SC	WF	WPD	TC	SC	WF	WPD	TC	SC	WF	WPD	TC	SC	WF	WPD	TC	SC	WF	WPD
°C	°C	°C	kW	kW	m³/h	kPa	kW	kW	m³/h	kPa	kW	kW	m³/h	kPa	kW	kW	m³/h	kPa	kW	kW	m³/h	kPa
11	3	15	1.09	1.09	0.31	7.52	1.40	1.40	0.40	11.55	1.70	1.70	0.49	16.22	2.01	2.01	0.57	21.50	2.31	2.31	0.66	27.45
		17	1.24	1.09	0.35	9.38	1.40	1.39	0.40	11.56	1.71	1.71	0.49	16.27	2.01	2.01	0.57	21.57	2.31	2.31	0.66	27.55
		19	-	-	-	-	2.20	1.40	0.63	25.15	2.17	1.71	0.62	24.66	2.16	2.01	0.62	24.47	2.31	2.31	0.66	27.64
		20	-	-	-	-	2.71	1.41	0.78	36.53	2.69	1.71	0.77	36.02	2.67	2.02	0.76	35.43	2.64	2.32	0.76	34.86
	4	15	0.92	0.92	0.20	3.14	1.23	1.23	0.26	5.70	1.54	1.54	0.33	8.33	1.85	1.85	0.40	11.33	2.15	2.15	0.46	14.68
		17	0.92	0.91	0.20	3.16	1.23	1.23	0.26	5.71	1.54	1.54	0.33	8.36	1.85	1.85	0.40	11.37	2.15	2.15	0.46	14.72
		19	-	-	-	-	1.75	1.24	0.37	10.34	1.74	1.55	0.37	10.25	1.86	1.86	0.40	11.53	2.16	2.16	0.46	14.77
		20	-	-	-	-	2.27	1.24	0.49	16.19	2.25	1.55	0.48	15.87	2.23	1.85	0.48	15.62	2.25	2.16	0.48	15.88
	5	15	0.78	0.78	0.13	1.15	1.07	1.07	0.18	2.68	1.38	1.38	0.24	4.73	1.69	1.69	0.29	6.66	1.99	1.99	0.34	8.83
		17	0.78	0.78	0.13	1.15	1.07	1.07	0.18	2.69	1.38	1.38	0.24	4.74	1.69	1.69	0.29	6.69	1.99	1.99	0.34	8.86
		19	-	-	-	-	1.28	1.07	0.22	4.13	1.40	1.39	0.24	4.88	1.69	1.69	0.29	6.71	2.00	2.00	0.34	8.89
		20	-	-	-	-	1.81	1.08	0.31	7.52	1.79	1.39	0.31	7.38	1.81	1.70	0.31	7.54	2.00	2.00	0.34	8.93
6	15	0.62	0.62	0.09	0.68	0.93	0.93	0.13	1.14	1.22	1.22	0.17	2.35	1.52	1.52	0.22	4.03	1.82	1.82	0.26	5.52	
	17	0.63	0.63	0.09	0.68	0.93	0.93	0.13	1.15	1.22	1.22	0.17	2.36	1.52	1.52	0.22	4.05	1.83	1.83	0.26	5.54	
	19	-	-	-	-	0.97	0.93	0.14	1.29	1.22	1.22	0.18	2.37	1.53	1.53	0.22	4.06	1.83	1.83	0.26	5.56	
	20	-	-	-	-	1.30	0.90	0.19	2.84	1.33	1.22	0.19	2.97	1.53	1.53	0.22	4.09	1.83	1.83	0.26	5.57	
13	3	15	0.77	0.77	0.22	4.19	1.09	1.09	0.31	7.51	1.40	1.40	0.40	11.51	1.70	1.70	0.49	16.15	2.00	2.00	0.58	21.39
		17	0.77	0.77	0.22	4.21	1.09	1.09	0.31	7.54	1.40	1.40	0.40	11.55	1.71	1.71	0.49	16.21	2.01	2.01	0.58	21.46
		19	-	-	-	-	1.34	1.09	0.39	10.73	1.42	1.41	0.41	11.81	1.71	1.71	0.49	16.27	2.01	2.01	0.58	21.54
		20	-	-	-	-	1.86	1.10	0.53	18.84	1.84	1.40	0.53	18.43	1.84	1.71	0.53	18.45	2.01	2.00	0.58	21.55
	4	15	0.62	0.62	0.13	1.16	0.92	0.92	0.20	3.29	1.23	1.23	0.26	5.60	1.54	1.54	0.33	8.18	1.84	1.84	0.39	11.13
		17	0.62	0.62	0.13	1.17	0.92	0.92	0.20	3.30	1.23	1.23	0.26	5.61	1.54	1.54	0.33	8.21	1.85	1.85	0.40	11.16
		19	-	-	-	-	0.94	0.93	0.20	3.44	1.23	1.23	0.26	5.63	1.54	1.54	0.33	8.24	1.85	1.85	0.40	11.20
		20	-	-	-	-	1.37	0.93	0.29	6.68	1.37	1.24	0.29	6.74	1.55	1.55	0.33	8.30	1.85	1.85	0.40	11.22
	5	15	0.47	0.47	0.08	0.59	0.77	0.77	0.13	1.15	1.07	1.07	0.18	2.72	1.38	1.38	0.24	4.62	1.68	1.68	0.29	6.50
		17	0.47	0.47	0.08	0.59	0.77	0.77	0.13	1.15	1.07	1.07	0.18	2.73	1.38	1.38	0.24	4.64	1.69	1.69	0.29	6.52
		19	-	-	-	-	0.77	0.77	0.13	1.15	1.07	1.07	0.18	2.75	1.38	1.38	0.24	4.65	1.69	1.69	0.29	6.54
		20	-	-	-	-	0.89	0.76	0.15	1.71	1.08	1.07	0.18	2.78	1.38	1.38	0.24	4.66	1.69	1.69	0.29	6.55
6	15	0.32	0.32	0.05	0.33	0.62	0.62	0.09	0.65	0.92	0.92	0.13	1.15	1.21	1.21	0.17	2.41	1.52	1.52	0.22	3.98	
	17	0.32	0.32	0.05	0.33	0.63	0.63	0.09	0.65	0.93	0.93	0.13	1.16	1.22	1.22	0.17	2.42	1.52	1.52	0.22	4.00	
	19	-	-	-	-	0.63	0.63	0.09	0.65	0.93	0.93	0.13	1.16	1.22	1.22	0.17	2.43	1.53	1.53	0.22	4.01	
	20	-	-	-	-	0.65	0.63	0.09	0.67	0.93	0.93	0.13	1.17	1.22	1.22	0.17	2.44	1.53	1.53	0.22	4.02	
15	3	15	0.47	0.47	0.13	1.16	0.77	0.77	0.22	4.08	1.09	1.09	0.31	7.28	1.39	1.39	0.40	11.15	1.70	1.70	0.49	15.88
		17	0.47	0.47	0.13	1.17	0.77	0.77	0.22	4.10	1.09	1.09	0.31	7.30	1.39	1.39	0.40	11.18	1.70	1.70	0.49	15.93
		19	-	-	-	-	0.78	0.77	0.22	4.11	1.09	1.09	0.31	7.33	1.40	1.40	0.40	11.22	1.70	1.70	0.49	15.98
		20	-	-	-	-	0.93	0.78	0.26	5.58	1.09	1.08	0.31	7.35	1.40	1.40	0.40	11.24	1.71	1.71	0.49	16.01
	4	15	0.32	0.32	0.07	0.48	0.62	0.62	0.13	1.17	0.92	0.92	0.20	3.30	1.23	1.23	0.26	5.53	1.54	1.54	0.33	8.06
		17	0.32	0.32	0.07	0.48	0.62	0.62	0.13	1.18	0.92	0.92	0.20	3.31	1.23	1.23	0.26	5.54	1.54	1.54	0.33	8.09
		19	-	-	-	-	0.62	0.62	0.13	1.19	0.92	0.92	0.20	3.32	1.24	1.24	0.27	5.56	1.54	1.54	0.33	8.11
		20	-	-	-	-	0.63	0.62	0.13	1.21	0.92	0.92	0.20	3.33	1.24	1.24	0.27	5.57	1.55	1.55	0.33	8.13
	5	15	0.16	0.16	0.03	0.20	0.47	0.47	0.08	0.57	0.77	0.77	0.13	1.20	1.07	1.07	0.18	2.84	1.38	1.38	0.24	4.60
		17	0.16	0.16	0.03	0.20	0.47	0.47	0.08	0.57	0.77	0.77	0.13	1.21	1.07	1.07	0.18	2.85	1.38	1.38	0.24	4.62
		19	-	-	-	-	0.48	0.48	0.08	0.57	0.78	0.78	0.13	1.21	1.07	1.07	0.18	2.87	1.38	1.38	0.24	4.63
		20	-	-	-	-	0.48	0.47	0.08	0.57	0.78	0.78	0.13	1.22	1.07	1.07	0.19	2.87	1.39	1.39	0.24	4.64
6	15	-	-	-	-	0.32	0.32	0.05	0.32	0.63	0.63	0.09	0.62	0.92	0.92	0.13	1.20	1.22	1.22	0.17	2.51	
	17	-	-	-	-	0.32	0.32	0.05	0.32	0.63	0.63	0.09	0.62	0.92	0.92	0.13	1.21	1.22	1.22	0.17	2.52	
	19	-	-	-	-	0.32	0.32	0.05	0.32	0.63	0.63	0.09	0.62	0.93	0.93	0.13	1.21	1.22	1.22	0.18	2.53	
	20	-	-	-	-	0.32	0.32	0.05	0.32	0.63	0.63	0.09	0.62	0.93	0.93	0.13	1.22	1.22	1.22	0.18	2.54	

Cooling capacity

MDVF-400D303E																							
EWT	ΔT	Indoor temp (W.B.)	Indoor temperature (D.B.)																				
			21				23				25				27				29				
			TC	SC	WF	WPD	TC	SC	WF	WPD	TC	SC	WF	WPD	TC	SC	WF	WPD	TC	SC	WF	WPD	
°C	°C	°C	kW	kW	m³/h	kPa	kW	kW	m³/h	kPa	kW	kW	m³/h	kPa	kW	kW	m³/h	kPa	kW	kW	m³/h	kPa	
5	3	15	3.65	2.88	1.05	24.59	3.61	3.31	1.04	24.19	3.73	3.73	1.07	25.62	4.15	4.15	1.19	30.46	4.57	4.57	1.31	35.97	
		17	4.93	2.88	1.41	41.24	4.89	3.32	1.40	40.74	4.86	3.74	1.39	40.07	4.81	4.16	1.38	39.40	4.77	4.58	1.37	38.80	
		19	-	-	-	-	6.27	3.33	1.81	63.33	6.23	3.76	1.80	62.58	6.18	4.17	1.77	60.87	6.14	4.59	1.76	60.20	
		20	-	-	-	-	7.00	3.33	2.02	76.87	6.95	3.76	2.01	75.99	6.91	4.19	2.00	75.11	6.86	4.61	1.98	74.25	
	4	15	3.10	2.63	0.66	11.16	3.10	3.07	0.66	11.17	3.49	3.49	0.75	13.69	3.92	3.92	0.85	16.86	4.34	4.34	0.94	20.07	
		17	4.40	2.65	0.95	20.58	4.37	3.08	0.94	20.32	4.34	3.51	0.93	20.03	4.30	3.93	0.93	19.73	4.34	4.33	0.94	20.10	
		19	-	-	-	-	5.74	3.08	1.23	32.23	5.70	3.51	1.22	31.85	5.66	3.94	1.21	31.47	5.62	4.36	1.21	31.09	
		20	-	-	-	-	6.47	3.09	1.39	39.76	6.43	3.52	1.38	39.48	6.39	3.95	1.37	39.04	6.34	4.37	1.36	38.31	
	5	15	2.54	2.38	0.44	5.45	2.82	2.82	0.48	6.47	3.26	3.26	0.56	8.25	3.68	3.68	0.63	10.18	4.10	4.10	0.70	12.25	
		17	3.85	2.40	0.66	10.99	3.82	2.84	0.66	10.83	3.78	3.26	0.65	10.65	3.77	3.69	0.65	10.61	4.11	4.11	0.71	12.29	
		19	-	-	-	-	5.21	2.85	0.90	18.60	5.18	3.28	0.89	18.38	5.14	3.71	0.89	18.15	5.10	4.13	0.88	17.91	
		20	-	-	-	-	5.93	2.85	1.02	23.06	5.89	3.28	1.01	22.79	5.85	3.71	1.00	22.52	5.81	4.13	1.00	22.26	
6	15	2.14	2.13	0.31	2.47	2.57	2.57	0.37	3.93	3.01	3.01	0.43	5.30	3.45	3.45	0.49	6.66	3.87	3.87	0.55	8.11		
	17	3.28	2.16	0.47	6.11	3.24	2.59	0.46	6.00	3.22	3.02	0.46	5.93	3.45	3.45	0.49	6.68	3.88	3.88	0.56	8.14		
	19	-	-	-	-	4.65	2.61	0.67	11.07	4.61	3.04	0.66	10.93	4.58	3.47	0.66	10.78	4.53	3.89	0.65	10.61		
	20	-	-	-	-	5.39	2.62	0.77	14.30	5.35	3.05	0.77	14.12	5.31	3.48	0.76	13.95	5.27	3.90	0.76	13.77		
7	3	15	2.65	2.43	0.76	13.87	2.87	2.87	0.83	16.12	3.30	3.30	0.95	20.50	3.72	3.72	1.07	24.91	4.14	4.14	1.20	30.43	
		17	3.94	2.44	1.13	27.51	3.91	2.87	1.12	27.12	3.87	3.30	1.11	26.68	3.85	3.73	1.10	26.39	4.15	4.15	1.20	30.54	
		19	-	-	-	-	5.28	2.88	1.52	45.89	5.24	3.31	1.51	45.31	5.21	3.74	1.50	44.77	5.17	4.16	1.48	44.18	
		20	-	-	-	-	6.02	2.89	1.74	58.04	5.98	3.32	1.72	57.35	5.93	3.75	1.71	56.65	5.89	4.17	1.69	55.54	
	4	15	2.18	2.16	0.47	6.10	2.63	2.63	0.57	8.37	3.06	3.06	0.66	10.85	3.49	3.49	0.75	13.64	3.91	3.91	0.85	16.59	
		17	3.39	2.20	0.73	12.97	3.36	2.64	0.73	12.74	3.33	3.07	0.72	12.57	3.50	3.49	0.76	13.67	3.92	3.92	0.84	16.57	
		19	-	-	-	-	4.73	2.64	1.02	22.82	4.70	3.08	1.01	22.54	4.66	3.50	1.00	22.23	4.62	3.93	0.99	21.89	
		20	-	-	-	-	5.47	2.66	1.18	29.66	5.43	3.09	1.18	29.29	5.39	3.51	1.16	28.57	5.35	3.93	1.15	28.20	
	5	15	1.94	1.94	0.33	3.16	2.39	2.39	0.41	4.81	2.82	2.82	0.49	6.40	3.25	3.25	0.56	8.14	3.68	3.68	0.63	10.03	
		17	2.79	1.96	0.48	6.26	2.76	2.39	0.47	6.15	2.83	2.83	0.49	6.43	3.26	3.26	0.56	8.17	3.68	3.68	0.63	10.07	
		19	-	-	-	-	4.16	2.41	0.72	12.39	4.13	2.84	0.71	12.21	4.05	3.21	0.73	29.25	4.05	3.69	0.70	11.85	
		20	-	-	-	-	4.89	2.42	0.84	16.44	4.86	2.85	0.84	16.23	4.82	3.28	0.83	16.02	4.78	3.70	0.82	15.79	
6	15	1.73	1.73	0.25	1.46	2.15	2.15	0.31	2.62	2.58	2.58	0.37	4.00	3.01	3.01	0.43	5.21	3.44	3.44	0.49	6.53		
	17	2.16	1.71	0.31	2.67	2.19	2.16	0.31	2.76	2.58	2.58	0.37	4.02	3.02	3.02	0.43	5.23	3.45	3.45	0.49	6.56		
	19	-	-	-	-	3.55	2.17	0.51	6.89	3.52	2.60	0.50	6.77	3.48	3.03	0.50	6.67	3.52	3.46	0.50	6.77		
	20	-	-	-	-	4.30	2.18	0.62	9.53	4.26	2.61	0.61	9.40	4.22	3.04	0.61	9.25	4.18	3.47	0.60	9.10		
9	3	15	1.99	1.99	0.57	8.37	2.43	2.43	0.70	11.77	2.86	2.86	0.82	15.70	3.29	3.29	0.94	19.82	3.71	3.71	1.06	24.45	
		17	2.89	2.00	0.83	15.94	2.85	2.43	0.82	15.64	2.88	2.87	0.83	15.89	3.29	3.29	0.95	19.89	3.72	3.72	1.07	24.53	
		19	-	-	-	-	4.25	2.44	1.23	31.34	4.21	2.88	1.22	30.91	4.18	3.31	1.21	30.43	4.14	3.73	1.20	29.95	
		20	-	-	-	-	4.96	2.44	1.43	40.63	4.93	2.88	1.42	40.11	4.89	3.31	1.41	39.60	4.85	3.73	1.40	39.05	
	4	15	1.75	1.75	0.38	4.12	2.19	2.19	0.47	5.99	2.62	2.62	0.56	8.17	3.05	3.05	0.66	10.60	3.48	3.48	0.75	13.40	
		17	2.27	1.75	0.49	6.38	2.27	2.19	0.49	6.41	2.63	2.63	0.57	8.20	3.06	3.06	0.66	10.63	3.49	3.49	0.76	13.45	
		19	-	-	-	-	3.65	2.20	0.78	14.37	3.61	2.64	0.78	14.12	3.58	3.07	0.77	14.00	3.59	3.50	0.77	14.02	
		20	-	-	-	-	4.38	2.21	0.95	19.82	4.35	2.65	0.94	19.57	4.31	3.08	0.93	19.28	4.27	3.50	0.92	18.97	
	5	15	1.51	1.51	0.26	1.70	1.94	1.94	0.33	3.24	2.39	2.39	0.41	4.73	2.82	2.82	0.49	6.29	3.25	3.25	0.56	7.99	
		17	1.65	1.51	0.28	2.15	1.95	1.94	0.33	3.25	2.39	2.39	0.41	4.75	2.83	2.83	0.49	6.31	3.25	3.25	0.56	8.02	
		19	-	-	-	-	3.02	1.96	0.52	7.07	2.99	2.40	0.51	6.94	2.99	2.83	0.51	6.93	3.26	3.25	0.56	8.05	
		20	-	-	-	-	3.77	1.97	0.65	10.31	3.73	2.41	0.64	10.14	3.70	2.84	0.64	9.97	3.67	3.27	0.63	9.83	
6	15	1.31	1.31	0.19	0.80	1.72	1.72	0.25	1.50	2.14	2.14	0.31	2.68	2.58	2.58	0.37	3.95	3.01	3.01	0.43	5.14		
	17	1.32	1.32	0.19	0.81	1.73	1.73	0.25	1.51	2.15	2.15	0.31	2.69	2.59	2.59	0.37	3.96	3.02	3.02	0.43	5.16		
	19	-	-	-	-	2.34	1.71	0.34	3.29	2.34	2.15	0.34	3.27	2.59	2.58	0.37	3.97	3.03	3.03	0.43	5.17		
	20	-	-	-	-	3.12	1.73	0.45	5.43	3.08	2.17	0.44	5.33	3.05	2.60	0.44	5.25	3.10	3.04	0.44	5.38		

Continued:

MDVF-400D303E																						
EWT	ΔT	Indoor temp (W.B.)	Indoor temperature (D.B.)																			
			21				23				25				27				29			
			TC	SC	WF	WPD	TC	SC	WF	WPD	TC	SC	WF	WPD	TC	SC	WF	WPD	TC	SC	WF	WPD
°C	°C	°C	kW	kW	m³/h	kPa	kW	kW	m³/h	kPa	kW	kW	m³/h	kPa	kW	kW	m³/h	kPa	kW	kW	m³/h	kPa
11	3	15	1.54	1.54	0.44	5.28	1.98	1.98	0.57	8.11	2.42	2.42	0.69	11.40	2.85	2.85	0.82	15.22	3.28	3.28	0.93	19.22
		17	1.74	1.54	0.50	6.48	1.99	1.98	0.57	8.13	2.42	2.42	0.69	11.44	2.86	2.86	0.82	15.28	3.28	3.28	0.94	19.28
		19	-	-	-	-	3.11	2.00	0.89	17.52	3.07	2.43	0.88	17.19	3.05	2.86	0.87	17.01	3.29	3.28	0.94	19.34
		20	-	-	-	-	3.84	2.00	1.10	25.34	3.81	2.44	1.09	24.96	3.77	2.87	1.08	24.53	3.74	3.29	1.07	24.14
	4	15	1.30	1.30	0.28	2.09	1.74	1.74	0.37	3.99	2.19	2.19	0.47	5.85	2.62	2.62	0.56	7.96	3.05	3.05	0.65	10.31
		17	1.30	1.28	0.28	2.08	1.75	1.75	0.37	4.00	2.19	2.19	0.47	5.87	2.63	2.63	0.56	7.99	3.05	3.05	0.65	10.34
		19	-	-	-	-	2.46	1.76	0.53	7.16	2.45	2.20	0.52	7.09	2.63	2.61	0.56	8.01	3.06	3.06	0.66	10.38
		20	-	-	-	-	3.21	1.76	0.69	11.26	3.17	2.20	0.68	11.05	3.14	2.63	0.67	10.87	3.16	3.07	0.68	10.95
	5	15	1.10	1.10	0.19	0.79	1.51	1.51	0.26	1.78	1.95	1.95	0.34	3.28	2.39	2.39	0.41	4.67	2.82	2.82	0.49	6.19
		17	1.10	1.10	0.19	0.79	1.52	1.52	0.26	1.79	1.95	1.95	0.34	3.29	2.39	2.39	0.41	4.68	2.82	2.82	0.49	6.21
		19	-	-	-	-	1.78	1.51	0.31	2.71	1.95	1.94	0.34	3.30	2.40	2.40	0.41	4.70	2.83	2.83	0.49	6.23
		20	-	-	-	-	2.54	1.53	0.44	5.18	2.51	1.96	0.43	5.09	2.53	2.41	0.44	5.14	2.83	2.82	0.49	6.24
6	15	0.88	0.88	0.13	0.50	1.31	1.31	0.19	0.78	1.72	1.72	0.25	1.56	2.15	2.15	0.31	2.74	2.58	2.58	0.37	3.90	
	17	0.88	0.88	0.13	0.50	1.31	1.31	0.19	0.79	1.73	1.73	0.25	1.57	2.15	2.15	0.31	2.76	2.59	2.59	0.37	3.91	
	19	-	-	-	-	1.35	1.33	0.19	0.83	1.73	1.73	0.25	1.58	2.16	2.16	0.31	2.77	2.59	2.59	0.37	3.93	
	20	-	-	-	-	1.83	1.28	0.26	1.84	1.85	1.73	0.27	1.89	2.16	2.14	0.31	2.77	2.60	2.60	0.37	3.93	
13	3	15	1.09	1.09	0.31	2.87	1.54	1.54	0.44	5.27	1.98	1.98	0.57	8.08	2.42	2.42	0.69	11.34	2.84	2.84	0.82	15.03
		17	1.10	1.10	0.31	2.88	1.55	1.55	0.44	5.29	1.99	1.99	0.57	8.11	2.42	2.42	0.70	11.38	2.85	2.85	0.82	15.08
		19	-	-	-	-	1.89	1.55	0.54	7.44	1.99	1.97	0.57	8.13	2.43	2.43	0.70	11.42	2.86	2.86	0.82	15.14
		20	-	-	-	-	2.61	1.55	0.74	12.79	2.58	1.99	0.74	12.54	2.58	2.43	0.74	12.54	2.86	2.85	0.82	15.15
	4	15	0.88	0.88	0.19	0.79	1.30	1.30	0.28	2.20	1.75	1.75	0.38	3.97	2.18	2.18	0.47	5.73	2.61	2.61	0.56	7.80
		17	0.88	0.88	0.19	0.79	1.30	1.30	0.28	2.21	1.75	1.75	0.38	3.98	2.18	2.18	0.47	5.75	2.62	2.62	0.56	7.83
		19	-	-	-	-	1.30	1.28	0.28	2.21	1.75	1.75	0.38	4.00	2.19	2.19	0.47	5.77	2.62	2.62	0.56	7.86
		20	-	-	-	-	1.93	1.31	0.41	4.69	1.93	1.76	0.42	4.70	2.19	2.17	0.47	5.77	2.63	2.63	0.56	7.88
	5	15	0.66	0.66	0.11	0.43	1.09	1.09	0.19	0.78	1.51	1.51	0.26	1.81	1.95	1.95	0.33	3.22	2.38	2.38	0.41	4.55
		17	0.66	0.66	0.11	0.43	1.10	1.10	0.19	0.78	1.51	1.51	0.26	1.82	1.95	1.95	0.33	3.23	2.39	2.39	0.41	4.56
		19	-	-	-	-	1.10	1.09	0.19	0.78	1.51	1.51	0.26	1.83	1.95	1.95	0.34	3.25	2.39	2.39	0.41	4.58
		20	-	-	-	-	1.26	1.08	0.22	1.11	1.51	1.50	0.26	1.82	1.96	1.96	0.34	3.25	2.40	2.40	0.41	4.59
6	15	0.45	0.45	0.06	0.24	0.88	0.88	0.13	0.47	1.31	1.31	0.19	0.78	1.72	1.72	0.25	1.59	2.15	2.15	0.31	2.75	
	17	0.45	0.45	0.06	0.24	0.88	0.88	0.13	0.47	1.31	1.31	0.19	0.78	1.72	1.72	0.25	1.60	2.15	2.15	0.31	2.76	
	19	-	-	-	-	0.88	0.88	0.13	0.47	1.31	1.31	0.19	0.78	1.72	1.72	0.25	1.61	2.15	2.15	0.31	2.77	
	20	-	-	-	-	0.90	0.90	0.13	0.48	1.31	1.31	0.19	0.78	1.73	1.73	0.25	1.62	2.16	2.16	0.31	2.78	
15	3	15	0.66	0.66	0.19	0.78	1.09	1.09	0.31	2.83	1.54	1.54	0.44	5.10	1.98	1.98	0.56	7.82	2.41	2.41	0.69	10.98
		17	0.66	0.66	0.19	0.79	1.09	1.09	0.31	2.84	1.54	1.54	0.44	5.12	1.98	1.98	0.56	7.85	2.41	2.41	0.69	11.02
		19	-	-	-	-	1.10	1.10	0.31	2.85	1.54	1.54	0.44	5.14	1.98	1.98	0.57	7.88	2.42	2.42	0.69	11.06
		20	-	-	-	-	1.29	1.10	0.37	3.81	1.54	1.52	0.44	5.12	1.99	1.99	0.57	7.90	2.42	2.42	0.69	11.08
	4	15	0.44	0.44	0.10	0.35	0.88	0.88	0.19	0.79	1.30	1.30	0.28	2.22	1.74	1.74	0.37	3.87	2.18	2.18	0.47	5.65
		17	0.45	0.45	0.10	0.35	0.88	0.88	0.19	0.79	1.30	1.30	0.28	2.23	1.75	1.75	0.37	3.88	2.18	2.18	0.47	5.67
		19	-	-	-	-	0.88	0.88	0.19	0.79	1.30	1.30	0.28	2.24	1.75	1.75	0.38	3.89	2.19	2.19	0.47	5.69
		20	-	-	-	-	0.88	0.86	0.19	0.79	1.31	1.31	0.28	2.25	1.75	1.75	0.38	3.90	2.19	2.19	0.47	5.70
	5	15	0.23	0.23	0.04	0.14	0.67	0.67	0.11	0.41	1.09	1.09	0.19	0.80	1.51	1.51	0.26	1.90	1.95	1.95	0.34	3.21
		17	0.23	0.23	0.04	0.14	0.67	0.67	0.11	0.41	1.10	1.10	0.19	0.80	1.51	1.51	0.26	1.91	1.95	1.95	0.34	3.22
		19	-	-	-	-	0.67	0.67	0.12	0.41	1.10	1.10	0.19	0.81	1.52	1.52	0.26	1.92	1.96	1.96	0.34	3.24
		20	-	-	-	-	0.67	0.67	0.12	0.42	1.10	1.10	0.19	0.81	1.52	1.52	0.26	1.92	1.96	1.96	0.34	3.24
6	15	-	-	-	-	0.45	0.45	0.06	0.23	0.88	0.88	0.13	0.45	1.31	1.31	0.19	0.80	1.72	1.72	0.25	1.67	
	17	-	-	-	-	0.45	0.45	0.06	0.23	0.88	0.88	0.13	0.45	1.31	1.31	0.19	0.80	1.72	1.72	0.25	1.67	
	19	-	-	-	-	0.45	0.45	0.06	0.23	0.89	0.89	0.13	0.45	1.31	1.31	0.19	0.80	1.72	1.72	0.25	1.68	
	20	-	-	-	-	0.45	0.45	0.06	0.23	0.89	0.89	0.13	0.45	1.31	1.31	0.19	0.81	1.73	1.73	0.25	1.69	

Cooling capacity

MDVF-500D303E																						
EWT	ΔT	Indoor temp (W.B.)	Indoor temperature (D.B.)																			
			21				23				25				27				29			
			TC	SC	WF	WPD	TC	SC	WF	WPD	TC	SC	WF	WPD	TC	SC	WF	WPD	TC	SC	WF	WPD
°C	°C	°C	kW	kW	m³/h	kPa	kW	kW	m³/h	kPa	kW	kW	m³/h	kPa	kW	kW	m³/h	kPa	kW	kW	m³/h	kPa
5	3	15	4.57	3.59	1.31	35.92	4.52	4.13	1.29	35.35	4.66	4.65	1.33	37.27	5.20	5.20	1.49	45.29	5.71	5.71	1.64	53.14
		17	6.18	3.61	1.78	61.67	6.12	4.14	1.75	59.94	6.08	4.68	1.74	59.22	6.03	5.20	1.73	58.42	5.99	5.73	1.72	57.68
		19	-	-	-	-	7.84	4.16	2.26	93.71	7.79	4.69	2.25	93.05	7.74	5.22	2.24	92.01	7.67	5.73	2.19	88.12
		20	-	-	-	-	8.75	4.17	2.54	114.40	8.70	4.70	2.52	113.07	8.64	5.23	2.50	111.81	8.58	5.75	2.48	109.65
	4	15	3.93	3.31	0.85	16.91	3.94	3.85	0.85	17.00	4.38	4.38	0.94	20.41	4.90	4.90	1.05	24.56	5.43	5.43	1.16	29.28
		17	5.52	3.31	1.18	30.14	5.48	3.85	1.18	29.77	5.44	4.38	1.17	29.36	5.39	4.91	1.16	28.92	5.46	5.45	1.17	29.62
		19	-	-	-	-	7.20	3.86	1.55	47.86	7.15	4.40	1.54	47.30	7.10	4.93	1.52	46.75	7.05	5.45	1.51	46.21
		20	-	-	-	-	8.12	3.87	1.75	59.61	8.06	4.41	1.74	58.94	8.01	4.94	1.73	58.27	7.96	5.47	1.72	57.62
	5	15	3.25	3.00	0.56	8.23	3.55	3.54	0.61	9.56	4.09	4.09	0.70	12.18	4.63	4.63	0.80	15.17	5.15	5.15	0.89	18.24
		17	4.88	3.02	0.84	16.59	4.84	3.57	0.83	16.36	4.79	4.10	0.83	16.10	4.80	4.64	0.83	16.13	5.16	5.16	0.89	18.30
		19	-	-	-	-	6.54	3.57	1.12	27.32	6.49	4.11	1.11	27.00	6.45	4.64	1.11	26.69	6.40	5.17	1.10	26.33
		20	-	-	-	-	7.46	3.58	1.29	34.59	7.41	4.12	1.28	34.20	7.36	4.65	1.27	33.80	7.31	5.18	1.26	33.41
6	15	2.71	2.71	0.39	4.37	3.26	3.26	0.47	6.05	3.80	3.80	0.54	7.86	4.34	4.34	0.62	9.84	4.87	4.87	0.70	12.03	
	17	4.17	2.72	0.60	9.21	4.13	3.27	0.59	9.05	4.11	3.81	0.59	8.99	4.35	4.35	0.62	9.90	4.88	4.88	0.70	12.07	
	19	-	-	-	-	5.87	3.29	0.84	16.59	5.83	3.83	0.84	16.39	5.78	4.36	0.83	16.16	5.74	4.89	0.82	15.92	
	20	-	-	-	-	6.77	3.29	0.97	21.07	6.72	3.83	0.96	20.82	6.68	4.36	0.96	20.58	6.63	4.89	0.95	20.32	
7	3	15	3.34	3.05	0.96	20.88	3.59	3.58	1.03	23.38	4.13	4.13	1.19	30.25	4.66	4.66	1.35	37.30	5.18	5.18	1.49	44.32
		17	4.94	3.05	1.42	40.84	4.91	3.60	1.42	40.87	4.87	4.13	1.41	40.28	4.85	4.67	1.40	39.96	5.19	5.19	1.49	44.47
		19	-	-	-	-	6.62	3.61	1.91	68.76	6.58	4.15	1.90	67.93	6.53	4.68	1.89	67.15	6.49	5.20	1.87	66.29
		20	-	-	-	-	7.54	3.62	2.19	86.98	7.49	4.15	2.17	85.95	7.44	4.69	2.16	85.00	7.39	5.21	2.15	84.03
	4	15	2.78	2.76	0.60	9.21	3.30	3.30	0.71	12.41	3.84	3.84	0.83	16.08	4.37	4.37	0.94	19.89	4.90	4.90	1.05	24.22
		17	4.26	2.76	0.92	19.03	4.22	3.30	0.91	18.70	4.19	3.84	0.90	18.47	4.38	4.38	0.94	19.99	4.90	4.90	1.05	24.30
		19	-	-	-	-	5.95	3.32	1.29	34.33	5.91	3.86	1.28	33.93	5.87	4.39	1.27	33.49	5.82	4.92	1.26	32.99
		20	-	-	-	-	6.86	3.32	1.49	43.98	6.81	3.86	1.48	43.46	6.77	4.40	1.46	42.95	6.72	4.93	1.45	42.43
	5	15	2.45	2.45	0.42	5.05	3.01	3.01	0.52	7.12	3.55	3.55	0.61	9.45	4.08	4.08	0.70	12.01	4.61	4.61	0.79	14.83
		17	3.54	2.47	0.61	9.41	3.51	3.01	0.60	9.27	3.62	3.56	0.62	9.77	4.09	4.09	0.70	12.05	4.62	4.62	0.80	14.88
		19	-	-	-	-	5.24	3.02	0.90	18.43	5.20	3.56	0.89	18.18	5.12	4.22	0.92	23.23	5.12	4.63	0.88	17.67
		20	-	-	-	-	6.15	3.03	1.06	24.32	6.11	3.57	1.05	24.02	6.07	4.11	1.04	23.73	6.02	4.64	1.04	23.40
6	15	2.16	2.16	0.31	2.66	2.71	2.71	0.39	4.38	3.26	3.26	0.47	5.95	3.80	3.80	0.54	7.73	4.33	4.33	0.62	9.66	
	17	2.76	2.16	0.40	4.49	2.83	2.72	0.41	4.68	3.26	3.26	0.47	5.97	3.81	3.81	0.55	7.75	4.34	4.34	0.62	9.70	
	19	-	-	-	-	4.52	2.73	0.65	10.37	4.47	3.28	0.64	10.19	4.43	3.81	0.64	10.05	4.50	4.35	0.65	10.33	
	20	-	-	-	-	5.43	2.74	0.78	14.24	5.40	3.29	0.77	14.12	5.35	3.83	0.77	13.95	5.31	4.36	0.76	13.79	
9	3	15	2.49	2.49	0.72	12.34	3.04	3.04	0.87	17.32	3.58	3.58	1.03	22.99	4.12	4.12	1.19	29.69	4.64	4.64	1.33	36.11
		17	3.62	2.50	1.04	23.50	3.59	3.04	1.03	23.06	3.63	3.59	1.04	23.59	4.12	4.12	1.19	29.79	4.65	4.65	1.34	36.22
		19	-	-	-	-	5.32	3.06	1.54	46.52	5.29	3.60	1.53	45.95	5.24	4.13	1.52	45.26	5.19	4.66	1.50	44.57
		20	-	-	-	-	6.23	3.06	1.81	61.39	6.17	3.60	1.78	59.60	6.13	4.13	1.77	58.87	6.08	4.66	1.75	58.10
	4	15	2.20	2.20	0.47	6.05	2.75	2.75	0.59	8.86	3.29	3.29	0.71	12.07	3.83	3.83	0.82	15.65	4.36	4.36	0.94	19.66
		17	2.89	2.20	0.62	9.61	2.91	2.76	0.63	9.73	3.30	3.29	0.71	12.10	3.84	3.84	0.83	15.70	4.37	4.37	0.94	19.72
		19	-	-	-	-	4.60	2.77	0.99	21.55	4.56	3.31	0.98	21.19	4.51	3.85	0.97	20.86	4.53	4.38	0.98	21.02
		20	-	-	-	-	5.50	2.77	1.18	29.22	5.46	3.31	1.18	28.85	5.41	3.85	1.17	28.45	5.36	4.38	1.15	27.99
	5	15	1.90	1.90	0.33	3.07	2.46	2.46	0.42	4.98	3.01	3.01	0.52	7.01	3.55	3.55	0.61	9.29	4.08	4.08	0.70	11.81
		17	2.12	1.90	0.36	3.85	2.46	2.45	0.42	4.99	3.01	3.01	0.52	7.03	3.55	3.55	0.61	9.32	4.09	4.09	0.70	11.85
		19	-	-	-	-	3.84	2.47	0.66	10.63	3.80	3.02	0.65	10.44	3.81	3.56	0.66	10.50	4.10	4.10	0.71	11.92
		20	-	-	-	-	4.76	2.48	0.82	15.39	4.73	3.03	0.82	15.26	4.68	3.57	0.81	15.00	4.65	4.10	0.80	14.82
6	15	1.63	1.63	0.23	1.29	2.16	2.16	0.31	2.72	2.71	2.71	0.39	4.30	3.26	3.26	0.47	5.87	3.80	3.80	0.54	7.61	
	17	1.66	1.64	0.24	1.35	2.16	2.16	0.31	2.73	2.72	2.72	0.39	4.31	3.27	3.27	0.47	5.89	3.80	3.80	0.55	7.63	
	19	-	-	-	-	3.03	2.18	0.43	5.18	3.03	2.73	0.44	5.19	3.30	3.28	0.47	6.00	3.81	3.81	0.55	7.66	
	20	-	-	-	-	3.97	2.19	0.57	8.22	3.93	2.73	0.56	8.06	3.90	3.27	0.56	7.96	3.99	3.82	0.57	8.28	

Continued:

MDVF-500D303E																						
EWT	ΔT	Indoor temp (W.B.)	Indoor temperature (D.B.)																			
			21				23				25				27				29			
			TC	SC	WF	WPD	TC	SC	WF	WPD	TC	SC	WF	WPD	TC	SC	WF	WPD	TC	SC	WF	WPD
°C	°C	°C	kW	kW	m³/h	kPa	kW	kW	m³/h	kPa	kW	kW	m³/h	kPa	kW	kW	m³/h	kPa	kW	kW	m³/h	kPa
11	3	15	1.94	1.94	0.55	7.80	2.49	2.49	0.71	11.97	3.03	3.03	0.87	16.82	3.57	3.57	1.02	22.32	4.10	4.10	1.18	28.59
		17	2.21	1.94	0.63	9.78	2.49	2.48	0.71	11.99	3.04	3.04	0.87	16.88	3.58	3.58	1.02	22.39	4.11	4.11	1.18	28.61
		19	-	-	-	-	3.91	2.50	1.12	26.13	3.87	3.04	1.10	25.62	3.85	3.58	1.10	25.43	4.11	4.10	1.18	28.59
		20	-	-	-	-	4.83	2.51	1.39	38.31	4.79	3.05	1.37	37.43	4.74	3.59	1.36	36.81	4.70	4.12	1.35	36.23
	4	15	1.64	1.64	0.35	3.59	2.20	2.20	0.47	5.92	2.75	2.75	0.59	8.64	3.29	3.29	0.70	11.75	3.82	3.82	0.82	15.22
		17	1.65	1.63	0.35	3.61	2.21	2.21	0.47	5.93	2.75	2.75	0.59	8.67	3.29	3.29	0.71	11.79	3.83	3.83	0.82	15.27
		19	-	-	-	-	3.12	2.21	0.67	10.76	3.11	2.76	0.67	10.68	3.32	3.31	0.71	11.97	3.84	3.84	0.82	15.32
		20	-	-	-	-	4.05	2.21	0.87	16.82	4.01	2.76	0.86	16.50	3.97	3.30	0.85	16.24	4.00	3.84	0.86	16.50
	5	15	1.37	1.37	0.24	1.35	1.91	1.91	0.33	3.14	2.46	2.46	0.42	4.92	3.01	3.01	0.52	6.91	3.54	3.54	0.61	9.15
		17	1.37	1.37	0.24	1.35	1.91	1.91	0.33	3.15	2.47	2.47	0.42	4.94	3.01	3.01	0.52	6.94	3.55	3.55	0.61	9.18
		19	-	-	-	-	2.32	1.92	0.40	4.43	2.52	2.48	0.43	5.12	3.02	3.02	0.52	6.96	3.56	3.56	0.61	9.21
		20	-	-	-	-	3.24	1.93	0.56	7.85	3.21	2.48	0.55	7.71	3.25	3.03	0.56	7.88	3.57	3.57	0.62	9.27
6	15	1.11	1.11	0.16	0.62	1.63	1.63	0.23	1.35	2.16	2.16	0.31	2.79	2.72	2.72	0.39	4.25	3.26	3.26	0.47	5.73	
	17	1.11	1.11	0.16	0.63	1.64	1.64	0.23	1.35	2.17	2.17	0.31	2.81	2.72	2.72	0.39	4.26	3.26	3.26	0.47	5.75	
	19	-	-	-	-	1.70	1.64	0.24	1.50	2.17	2.17	0.31	2.82	2.73	2.73	0.39	4.28	3.27	3.27	0.47	5.77	
	20	-	-	-	-	2.35	1.62	0.34	3.30	2.39	2.18	0.34	3.41	2.75	2.74	0.39	4.33	3.27	3.27	0.47	5.78	
13	3	15	1.38	1.38	0.40	4.38	1.94	1.94	0.56	7.79	2.49	2.49	0.71	11.93	3.03	3.03	0.87	16.76	3.56	3.56	1.02	22.21
		17	1.39	1.39	0.40	4.40	1.94	1.94	0.56	7.82	2.49	2.49	0.72	11.97	3.03	3.03	0.87	16.81	3.57	3.57	1.03	22.28
		19	-	-	-	-	2.39	1.95	0.69	11.17	2.53	2.51	0.73	12.26	3.04	3.04	0.87	16.87	3.58	3.58	1.03	22.36
		20	-	-	-	-	3.31	1.95	0.95	19.55	3.27	2.50	0.94	19.16	3.27	3.04	0.94	19.18	3.58	3.57	1.03	22.38
	4	15	1.10	1.10	0.24	1.39	1.65	1.65	0.35	3.59	2.20	2.20	0.47	5.81	2.74	2.74	0.59	8.49	3.28	3.28	0.70	11.54
		17	1.10	1.10	0.24	1.39	1.65	1.65	0.36	3.61	2.20	2.20	0.47	5.83	2.75	2.75	0.59	8.51	3.29	3.29	0.70	11.57
		19	-	-	-	-	1.69	1.67	0.36	3.76	2.20	2.20	0.47	5.85	2.75	2.75	0.59	8.55	3.29	3.29	0.71	11.62
		20	-	-	-	-	2.45	1.65	0.52	6.99	2.46	2.21	0.53	7.05	2.77	2.77	0.59	8.62	3.30	3.30	0.71	11.64
	5	15	0.83	0.83	0.14	0.54	1.36	1.36	0.23	1.37	1.90	1.90	0.33	3.10	2.46	2.46	0.42	4.80	3.00	3.00	0.51	6.74
		17	0.84	0.84	0.14	0.54	1.36	1.36	0.23	1.38	1.91	1.91	0.33	3.11	2.46	2.46	0.42	4.81	3.01	3.01	0.52	6.76
		19	-	-	-	-	1.37	1.36	0.23	1.38	1.91	1.91	0.33	3.13	2.47	2.47	0.42	4.83	3.01	3.01	0.52	6.78
		20	-	-	-	-	1.57	1.35	0.27	2.03	1.92	1.92	0.33	3.16	2.47	2.47	0.42	4.84	3.02	3.02	0.52	6.80
6	15	0.57	0.57	0.08	0.30	1.11	1.11	0.16	0.59	1.63	1.63	0.23	1.38	2.17	2.17	0.31	2.80	2.72	2.72	0.39	4.16	
	17	0.57	0.57	0.08	0.30	1.11	1.11	0.16	0.59	1.63	1.63	0.23	1.39	2.17	2.17	0.31	2.81	2.72	2.72	0.39	4.17	
	19	-	-	-	-	1.11	1.11	0.16	0.60	1.63	1.63	0.23	1.39	2.18	2.18	0.31	2.82	2.73	2.73	0.39	4.19	
	20	-	-	-	-	1.15	1.13	0.16	0.62	1.64	1.63	0.23	1.40	2.18	2.18	0.31	2.83	2.73	2.73	0.39	4.19	
15	3	15	0.82	0.82	0.23	1.40	1.38	1.38	0.39	4.25	1.93	1.93	0.55	7.55	2.48	2.48	0.71	11.56	3.02	3.02	0.87	16.47
		17	0.82	0.82	0.23	1.40	1.38	1.38	0.39	4.26	1.94	1.94	0.55	7.57	2.48	2.48	0.71	11.60	3.03	3.03	0.87	16.52
		19	-	-	-	-	1.39	1.38	0.40	4.27	1.94	1.94	0.55	7.60	2.49	2.49	0.71	11.64	3.03	3.03	0.87	16.58
		20	-	-	-	-	1.66	1.39	0.47	5.84	1.95	1.93	0.56	7.64	2.49	2.49	0.71	11.66	3.04	3.04	0.87	16.61
	4	15	0.56	0.56	0.12	0.44	1.09	1.09	0.23	1.41	1.65	1.65	0.35	3.51	2.20	2.20	0.47	5.73	2.74	2.74	0.59	8.35
		17	0.56	0.56	0.12	0.44	1.09	1.09	0.23	1.42	1.65	1.65	0.35	3.52	2.20	2.20	0.47	5.75	2.74	2.74	0.59	8.38
		19	-	-	-	-	1.10	1.10	0.24	1.43	1.65	1.65	0.35	3.53	2.21	2.21	0.47	5.77	2.75	2.75	0.59	8.41
		20	-	-	-	-	1.10	1.08	0.24	1.44	1.65	1.65	0.35	3.54	2.21	2.21	0.47	5.78	2.75	2.75	0.59	8.43
	5	15	0.29	0.29	0.05	0.18	0.84	0.84	0.14	0.52	1.36	1.36	0.24	1.45	1.91	1.91	0.33	3.11	2.46	2.46	0.42	4.77
		17	0.29	0.29	0.05	0.18	0.84	0.84	0.14	0.52	1.37	1.37	0.24	1.45	1.92	1.92	0.33	3.12	2.47	2.47	0.43	4.79
		19	-	-	-	-	0.84	0.84	0.15	0.52	1.37	1.37	0.24	1.46	1.92	1.92	0.33	3.13	2.47	2.47	0.43	4.81
		20	-	-	-	-	0.84	0.84	0.15	0.52	1.37	1.37	0.24	1.47	1.92	1.92	0.33	3.14	2.47	2.47	0.43	4.82
6	15	-	-	-	-	0.57	0.57	0.08	0.29	1.11	1.11	0.16	0.58	1.63	1.63	0.23	1.45	2.17	2.17	0.31	2.81	
	17	-	-	-	-	0.57	0.57	0.08	0.29	1.11	1.11	0.16	0.58	1.63	1.63	0.23	1.45	2.18	2.18	0.31	2.82	
	19	-	-	-	-	0.57	0.57	0.08	0.29	1.12	1.12	0.16	0.58	1.64	1.64	0.23	1.46	2.18	2.18	0.31	2.84	
	20	-	-	-	-	0.57	0.57	0.08	0.29	1.12	1.12	0.16	0.58	1.64	1.64	0.24	1.47	2.18	2.18	0.31	2.84	

Continued:

MDVF-600D303E																						
EWT	ΔT	Indoor temp (W.B.)	Indoor temperature (D.B.)																			
			21				23				25				27				29			
			TC	SC	WF	WPD	TC	SC	WF	WPD	TC	SC	WF	WPD	TC	SC	WF	WPD	TC	SC	WF	WPD
°C	°C	°C	kW	kW	m³/h	kPa	kW	kW	m³/h	kPa	kW	kW	m³/h	kPa	kW	kW	m³/h	kPa	kW	kW	m³/h	kPa
11	3	15	2.42	2.42	0.69	14.90	3.09	3.09	0.88	22.53	3.75	3.75	1.07	31.53	4.41	4.41	1.27	42.32	5.05	5.05	1.46	53.78
		17	2.84	2.42	0.81	19.44	3.12	3.11	0.89	22.92	3.76	3.76	1.07	31.64	4.41	4.41	1.27	42.47	5.06	5.06	1.46	53.97
		19	-	-	-	-	4.91	3.11	1.41	51.09	4.86	3.77	1.40	50.16	4.83	4.42	1.38	49.04	5.10	5.09	1.47	54.70
		20	-	-	-	-	6.02	3.11	1.74	73.21	5.97	3.77	1.72	72.16	5.91	4.43	1.71	70.97	5.87	5.08	1.69	70.06
	4	15	2.08	2.08	0.44	6.94	2.75	2.75	0.59	11.23	3.42	3.42	0.73	16.29	4.07	4.07	0.87	22.04	4.72	4.72	1.01	28.51
		17	2.16	2.09	0.46	7.41	2.76	2.75	0.59	11.27	3.42	3.42	0.73	16.34	4.08	4.08	0.87	22.11	4.73	4.73	1.01	28.61
		19	-	-	-	-	3.97	2.76	0.85	21.11	3.97	3.43	0.85	21.09	4.20	4.10	0.90	23.29	4.74	4.74	1.02	28.72
		20	-	-	-	-	5.11	2.77	1.10	32.82	5.06	3.43	1.09	32.24	5.02	4.09	1.08	31.82	5.08	4.76	1.09	32.46
	5	15	1.73	1.73	0.30	3.26	2.41	2.41	0.42	6.16	3.08	3.08	0.53	9.36	3.74	3.74	0.64	12.90	4.40	4.40	0.76	17.19
		17	1.73	1.72	0.30	3.28	2.42	2.42	0.42	6.18	3.09	3.09	0.53	9.39	3.75	3.75	0.64	12.95	4.41	4.41	0.76	17.25
		19	-	-	-	-	3.06	2.42	0.53	9.20	3.29	3.11	0.57	10.45	3.76	3.76	0.64	13.03	4.42	4.42	0.76	17.32
		20	-	-	-	-	4.16	2.43	0.72	15.60	4.13	3.10	0.71	15.41	4.20	3.77	0.72	15.85	4.52	4.43	0.78	18.04
6	15	1.41	1.41	0.20	1.18	2.06	2.06	0.30	3.25	2.74	2.74	0.39	5.53	3.41	3.41	0.49	8.03	4.06	4.06	0.58	10.85	
	17	1.41	1.41	0.20	1.19	2.07	2.07	0.30	3.26	2.74	2.74	0.39	5.55	3.41	3.41	0.49	8.05	4.07	4.07	0.58	10.89	
	19	-	-	-	-	2.26	2.08	0.32	3.96	2.77	2.76	0.40	5.64	3.42	3.42	0.49	8.09	4.08	4.08	0.58	10.93	
	20	-	-	-	-	3.14	2.07	0.45	6.97	3.21	2.75	0.46	7.26	3.57	3.43	0.51	8.71	4.09	4.09	0.58	10.97	
13	3	15	1.74	1.74	0.50	8.37	2.41	2.41	0.69	14.46	3.08	3.08	0.89	22.40	3.73	3.73	1.07	30.89	4.39	4.39	1.26	41.20
		17	1.74	1.74	0.50	8.39	2.41	2.41	0.69	14.51	3.09	3.09	0.89	22.47	3.74	3.74	1.07	31.00	4.40	4.40	1.26	41.35
		19	-	-	-	-	3.05	2.42	0.88	22.03	3.21	3.11	0.92	24.03	3.75	3.74	1.07	31.11	4.41	4.41	1.26	41.50
		20	-	-	-	-	4.15	2.42	1.19	37.13	4.11	3.09	1.17	36.47	4.12	3.76	1.18	36.70	4.44	4.42	1.27	42.02
	4	15	1.38	1.38	0.30	3.33	2.07	2.07	0.44	6.80	2.74	2.74	0.59	11.01	3.41	3.41	0.73	16.16	4.06	4.06	0.88	21.84
		17	1.39	1.39	0.30	3.35	2.07	2.07	0.44	6.82	2.75	2.75	0.59	11.05	3.42	3.42	0.74	16.21	4.07	4.07	0.88	21.92
		19	-	-	-	-	2.23	2.09	0.48	7.73	2.76	2.75	0.59	11.10	3.42	3.42	0.74	16.28	4.08	4.08	0.88	22.00
		20	-	-	-	-	3.16	2.08	0.68	14.05	3.21	2.76	0.69	14.54	3.52	3.44	0.76	17.08	4.08	4.08	0.88	22.04
	5	15	1.06	1.06	0.18	0.95	1.72	1.72	0.30	3.27	2.41	2.41	0.41	5.99	3.07	3.07	0.53	9.10	3.73	3.73	0.64	12.68
		17	1.06	1.06	0.18	0.95	1.73	1.73	0.30	3.29	2.41	2.41	0.41	6.02	3.08	3.08	0.53	9.13	3.74	3.74	0.64	12.73
		19	-	-	-	-	1.73	1.73	0.30	3.32	2.42	2.42	0.41	6.04	3.09	3.09	0.53	9.17	3.75	3.75	0.64	12.78
		20	-	-	-	-	2.16	1.73	0.37	5.00	2.54	2.43	0.44	6.56	3.09	3.08	0.53	9.19	3.75	3.75	0.64	12.80
6	15	0.73	0.73	0.10	0.50	1.40	1.40	0.20	1.20	2.06	2.06	0.29	3.27	2.74	2.74	0.39	5.45	3.40	3.40	0.49	7.89	
	17	0.73	0.73	0.10	0.50	1.41	1.41	0.20	1.20	2.06	2.06	0.30	3.28	2.74	2.74	0.39	5.47	3.41	3.41	0.49	7.92	
	19	-	-	-	-	1.41	1.41	0.20	1.21	2.07	2.07	0.30	3.30	2.75	2.75	0.39	5.50	3.42	3.42	0.49	7.95	
	20	-	-	-	-	1.51	1.42	0.22	1.46	2.07	2.06	0.30	3.31	2.75	2.75	0.39	5.51	3.42	3.42	0.49	7.97	
15	3	15	-	-	-	-	1.73	1.73	0.49	8.09	2.41	2.41	0.69	14.46	3.06	3.06	0.87	21.63	3.72	3.72	1.06	30.28
		17	-	-	-	-	1.73	1.73	0.49	8.12	2.41	2.41	0.69	14.27	3.07	3.07	0.88	21.69	3.73	3.73	1.06	30.39
		19	-	-	-	-	1.74	1.72	0.50	8.14	2.42	2.42	0.70	14.57	3.07	3.07	0.88	21.77	3.73	3.73	1.07	30.51
		20	-	-	-	-	2.17	1.73	0.62	11.91	2.48	2.44	0.71	15.17	3.08	3.08	0.88	21.81	3.74	3.74	1.07	30.57
	4	15	-	-	-	-	1.38	1.38	0.30	3.32	2.07	2.07	0.44	6.70	2.74	2.74	0.59	10.96	3.40	3.40	0.73	15.84
		17	0.49	0.49	0.02	0.08	1.39	1.39	0.30	3.34	2.07	2.07	0.44	6.72	2.75	2.75	0.59	10.99	3.40	3.40	0.73	15.90
		19	-	-	-	-	1.39	1.39	0.30	3.36	2.08	2.08	0.45	6.75	2.75	2.75	0.59	11.04	3.41	3.41	0.74	15.96
		20	-	-	-	-	1.43	1.41	0.31	3.58	2.08	2.07	0.45	6.76	2.76	2.76	0.59	11.06	3.42	3.42	0.74	16.00
	5	15	-	-	-	-	1.06	1.06	0.18	0.97	1.72	1.72	0.30	3.35	2.40	2.40	0.41	5.94	3.07	3.07	0.53	9.01
		17	0.37	0.37	0.06	0.30	1.07	1.07	0.18	0.97	1.73	1.73	0.30	3.36	2.41	2.41	0.42	5.97	3.07	3.07	0.53	9.05
		19	-	-	-	-	1.07	1.07	0.18	0.98	1.73	1.73	0.30	3.38	2.41	2.41	0.42	5.99	3.08	3.08	0.53	9.08
		20	-	-	-	-	1.07	1.06	0.18	0.98	1.73	1.73	0.30	3.38	2.42	2.42	0.42	6.00	3.08	3.08	0.53	9.10
6	15	-	-	-	-	0.73	0.73	0.10	0.48	1.40	1.40	0.20	1.24	2.06	2.06	0.30	3.31	2.73	2.73	0.39	5.40	
	17	-	-	-	-	0.73	0.73	0.10	0.48	1.40	1.40	0.20	1.25	2.06	2.06	0.30	3.32	2.74	2.74	0.39	5.42	
	19	-	-	-	-	0.73	0.73	0.10	0.48	1.40	1.40	0.20	1.26	2.07	2.07	0.30	3.34	2.75	2.75	0.39	5.44	
	20	-	-	-	-	0.73	0.73	0.10	0.48	1.41	1.41	0.20	1.26	2.07	2.07	0.30	3.35	2.75	2.75	0.39	5.45	

Cooling capacity

MDVF-800D303E																							
EWT	ΔT	Indoor temp (W.B.)	Indoor temperature (D.B.)																				
			21				23				25				27				29				
			TC	SC	WF	WPD	TC	SC	WF	WPD	TC	SC	WF	WPD	TC	SC	WF	WPD	TC	SC	WF	WPD	
°C	°C	°C	kW	kW	m³/h	kPa	kW	kW	m³/h	kPa	kW	kW	m³/h	kPa	kW	kW	m³/h	kPa	kW	kW	m³/h	kPa	
5	3	15	7.24	5.64	2.09	63.20	7.18	6.47	2.07	62.32	7.32	7.30	2.11	64.48	8.10	8.10	2.34	77.00	8.89	8.89	2.57	90.94	
		17	9.71	5.66	2.81	106.34	9.64	6.49	2.79	104.95	9.57	7.31	2.77	103.48	9.46	8.11	2.72	100.18	9.41	8.90	2.70	99.11	
		19	-	-	-	-	12.27	6.50	3.54	159.01	12.18	7.32	3.51	157.06	12.09	8.13	3.49	155.05	12.02	8.93	3.47	153.28	
		20	-	-	-	-	13.67	6.51	3.94	192.33	13.58	7.34	3.92	190.04	13.48	8.15	3.89	187.73	13.39	8.95	3.86	185.48	
	4	15	6.26	5.20	1.34	29.26	6.29	6.04	1.35	29.51	6.86	6.85	1.47	34.22	7.67	7.67	1.65	41.56	8.47	8.47	1.82	49.43	
		17	8.77	5.23	1.89	52.70	8.69	6.05	1.87	51.75	8.61	6.87	1.85	50.88	8.55	7.68	1.84	50.24	8.63	8.50	1.85	51.12	
		19	-	-	-	-	11.34	6.07	2.44	82.40	11.26	6.90	2.42	81.35	11.17	7.71	2.40	80.27	11.09	8.51	2.38	79.20	
		20	-	-	-	-	12.76	6.09	2.76	102.46	12.67	6.92	2.74	101.21	12.58	7.73	2.72	99.96	12.49	8.53	2.71	98.73	
	5	15	5.35	4.78	0.92	15.21	5.67	5.63	0.98	16.81	6.44	6.44	1.11	20.88	7.25	7.25	1.24	25.47	8.06	8.06	1.39	30.83	
		17	7.81	4.80	1.35	29.17	7.71	5.62	1.32	28.36	7.65	6.44	1.31	27.95	7.69	7.28	1.33	28.42	8.09	8.08	1.39	31.01	
		19	-	-	-	-	10.37	5.64	1.78	47.45	10.30	6.47	1.77	46.84	10.22	7.28	1.75	46.18	10.13	8.09	1.74	45.51	
		20	-	-	-	-	11.78	5.66	2.03	59.25	11.70	6.48	2.01	58.63	11.63	7.30	2.00	58.10	11.54	8.11	1.99	57.33	
	6	15	4.52	4.35	0.65	8.30	5.18	5.18	0.74	10.46	6.01	6.01	0.86	13.53	6.82	6.82	0.98	16.69	7.63	7.63	1.09	20.24	
		17	6.78	4.36	0.97	16.60	6.72	5.19	0.96	16.35	6.71	6.03	0.96	16.33	6.98	6.85	1.00	17.34	7.65	7.65	1.09	20.32	
		19	-	-	-	-	9.41	5.22	1.35	29.20	9.31	6.04	1.33	28.48	9.23	6.86	1.32	28.05	9.15	7.66	1.31	27.68	
		20	-	-	-	-	10.79	5.22	1.54	36.78	10.70	6.05	1.53	36.30	10.62	6.87	1.52	35.82	10.55	7.68	1.51	35.54	
	7	3	15	5.34	4.78	1.54	36.87	5.63	5.62	1.63	40.36	6.43	6.43	1.85	50.34	7.25	7.25	2.09	62.52	8.05	8.05	2.32	74.66
			17	7.82	4.80	2.27	71.86	7.75	5.64	2.25	70.73	7.67	6.45	2.22	69.01	7.64	7.27	2.21	68.58	8.07	8.06	2.32	74.92
			19	-	-	-	-	10.41	5.66	3.03	119.35	10.31	6.47	2.98	115.79	10.23	7.29	2.96	114.20	10.14	8.09	2.93	112.42
			20	-	-	-	-	11.81	5.67	3.45	149.61	11.71	6.49	3.39	145.45	11.64	7.31	3.38	144.72	11.54	8.11	3.34	141.66
		4	15	4.50	4.37	0.97	16.54	5.18	5.18	1.11	20.89	6.01	6.01	1.29	26.98	6.84	6.84	1.48	34.01	7.64	7.64	1.65	41.29
			17	6.81	4.37	1.47	33.76	6.74	5.20	1.46	33.21	6.71	6.03	1.45	32.91	6.93	6.86	1.50	34.86	7.66	7.66	1.66	41.44
			19	-	-	-	-	9.39	5.21	2.02	58.58	9.31	6.04	2.01	57.74	9.23	6.86	1.99	56.88	9.16	7.67	1.97	56.06
			20	-	-	-	-	10.81	5.23	2.34	75.56	10.73	6.06	2.32	74.53	10.65	6.88	2.31	73.55	10.56	7.69	2.29	72.50
5		15	3.92	3.91	0.67	8.78	4.76	4.76	0.82	12.23	5.59	5.59	0.96	16.18	6.41	6.41	1.10	20.37	7.22	7.22	1.24	25.02	
		17	5.75	3.93	0.99	16.94	5.71	4.77	0.98	16.76	5.85	5.61	1.01	17.42	6.42	6.42	1.10	20.45	7.23	7.23	1.24	25.11	
		19	-	-	-	-	8.36	4.79	1.44	32.23	8.30	5.62	1.44	32.11	8.31	6.30	1.50	76.81	8.19	7.26	1.42	31.34	
		20	-	-	-	-	9.79	4.80	1.69	42.80	9.72	5.64	1.68	42.21	9.62	6.45	1.66	41.12	9.53	7.26	1.64	40.49	
6		15	3.47	3.47	0.50	5.17	4.32	4.32	0.62	7.57	5.16	5.16	0.74	10.24	6.00	6.00	0.86	13.30	6.80	6.80	0.98	16.43	
		17	4.65	3.48	0.67	8.55	4.74	4.35	0.68	8.85	5.22	5.18	0.75	10.42	6.01	6.01	0.86	13.35	6.82	6.82	0.98	16.49	
		19	-	-	-	-	7.29	4.36	1.05	18.54	7.23	5.19	1.04	18.24	7.18	6.01	1.03	18.06	7.29	6.85	1.05	18.54	
		20	-	-	-	-	8.72	4.38	1.26	25.33	8.65	5.21	1.24	24.94	8.57	6.03	1.23	24.55	8.50	6.84	1.22	24.22	
9		3	15	3.92	3.91	1.12	20.99	4.77	4.77	1.38	29.85	5.59	5.59	1.61	38.84	6.41	6.41	1.86	50.05	7.22	7.22	2.10	61.68
			17	5.75	3.93	1.65	40.86	5.70	4.77	1.64	40.22	5.78	5.62	1.68	41.79	6.43	6.43	1.86	50.23	7.24	7.24	2.10	61.90
			19	-	-	-	-	8.36	4.79	2.41	78.88	8.29	5.61	2.39	77.60	8.22	6.44	2.37	76.66	8.16	7.25	2.36	76.10
			20	-	-	-	-	9.78	4.80	2.84	104.89	9.72	5.64	2.83	104.23	9.64	6.46	2.81	102.81	9.56	7.27	2.78	101.22
		4	15	3.49	3.49	0.75	10.44	4.33	4.33	0.93	15.14	5.17	5.17	1.12	20.60	5.99	5.99	1.30	26.72	6.80	6.80	1.46	32.93
			17	4.68	3.49	1.01	17.31	4.72	4.35	1.02	17.59	5.19	5.19	1.12	20.75	6.01	6.01	1.30	26.82	6.81	6.81	1.47	33.05
			19	-	-	-	-	7.29	4.36	1.57	37.20	7.22	5.19	1.56	36.57	7.17	6.01	1.54	36.09	7.21	6.84	1.55	36.45
			20	-	-	-	-	8.73	4.38	1.89	51.40	8.66	5.21	1.88	50.65	8.55	6.02	1.84	49.11	8.48	6.84	1.83	48.38
	5	15	3.05	3.05	0.52	5.65	3.90	3.90	0.67	8.60	4.74	4.74	0.82	11.99	5.57	5.57	0.96	15.78	6.39	6.39	1.10	19.98	
		17	3.59	3.06	0.62	7.44	3.99	3.93	0.69	8.94	4.75	4.75	0.82	12.03	5.58	5.58	0.96	15.84	6.40	6.40	1.10	20.05	
		19	-	-	-	-	6.18	3.92	1.06	18.86	6.13	4.76	1.06	18.60	6.16	5.60	1.06	18.79	6.52	6.43	1.12	20.72	
		20	-	-	-	-	7.61	3.94	1.31	27.07	7.53	4.77	1.30	26.58	7.47	5.60	1.29	26.16	7.43	6.42	1.28	25.95	
	6	15	2.62	2.62	0.37	2.75	3.47	3.47	0.50	5.13	4.32	4.32	0.62	7.43	5.15	5.15	0.74	10.04	5.97	5.97	0.86	12.93	
		17	2.74	2.64	0.39	3.11	3.48	3.47	0.50	5.14	4.33	4.33	0.62	7.46	5.16	5.16	0.74	10.08	5.98	5.98	0.86	12.98	
		19	-	-	-	-	5.02	3.49	0.72	9.60	5.05	4.34	0.72	9.69	5.39	5.19	0.77	10.84	6.00	5.99	0.86	13.03	
		20	-	-	-	-	6.44	3.50	0.92	14.72	6.38	4.34	0.92	14.48	6.35	5.17	0.91	14.37	6.49	6.02	0.93	14.92	

Continued:

MDVF-800D303E																						
EWT	ΔT	Indoor temp (W.B.)	Indoor temperature (D.B.)																			
			21				23				25				27				29			
			TC	SC	WF	WPD	TC	SC	WF	WPD	TC	SC	WF	WPD	TC	SC	WF	WPD	TC	SC	WF	WPD
°C	°C	°C	kW	kW	m³/h	kPa	kW	kW	m³/h	kPa	kW	kW	m³/h	kPa	kW	kW	m³/h	kPa	kW	kW	m³/h	kPa
11	3	15	3.06	3.06	0.87	13.35	3.90	3.90	1.11	20.34	4.74	4.74	1.36	28.62	5.57	5.57	1.60	38.16	6.38	6.38	1.82	47.72
		17	3.59	3.06	1.02	17.56	3.94	3.94	1.12	20.66	4.75	4.75	1.36	28.59	5.58	5.58	1.61	38.30	6.39	6.39	1.83	47.90
		19	-	-	-	-	6.18	3.92	1.77	45.10	6.12	4.76	1.75	44.35	6.10	5.59	1.74	44.20	6.43	6.42	1.84	48.46
		20	-	-	-	-	7.62	3.94	2.20	66.16	7.55	4.78	2.18	65.03	7.48	5.60	2.16	63.92	7.40	6.41	2.12	61.97
	4	15	2.62	2.62	0.56	6.28	3.48	3.48	0.75	10.14	4.32	4.32	0.93	14.70	5.15	5.15	1.10	19.87	5.96	5.96	1.28	25.64
		17	2.72	2.66	0.58	6.66	3.49	3.48	0.75	10.18	4.33	4.33	0.93	14.75	5.16	5.16	1.10	19.94	5.98	5.98	1.28	25.74
		19	-	-	-	-	5.03	3.49	1.08	19.09	5.02	4.33	1.08	19.06	5.31	5.19	1.14	20.96	5.99	5.99	1.28	25.84
		20	-	-	-	-	6.45	3.51	1.39	29.46	6.39	4.34	1.37	28.91	6.34	5.17	1.36	28.54	6.41	6.01	1.37	29.08
	5	15	2.19	2.19	0.38	2.84	3.05	3.05	0.52	5.56	3.90	3.90	0.67	8.44	4.73	4.73	0.81	11.76	5.56	5.56	0.96	15.49
		17	2.19	2.18	0.38	2.85	3.06	3.06	0.53	5.58	3.91	3.91	0.67	8.47	4.74	4.74	0.82	11.80	5.57	5.57	0.96	15.55
		19	-	-	-	-	3.87	3.06	0.67	8.32	4.15	3.93	0.71	9.39	4.76	4.75	0.82	11.87	5.58	5.58	0.96	15.61
		20	-	-	-	-	5.23	3.06	0.90	13.85	5.19	3.90	0.89	13.69	5.28	4.76	0.91	14.08	5.70	5.60	0.98	16.21
6	15	1.78	1.78	0.26	1.04	2.61	2.61	0.37	2.83	3.45	3.45	0.49	4.99	4.30	4.30	0.62	7.24	5.13	5.13	0.73	9.77	
	17	1.79	1.79	0.26	1.05	2.62	2.62	0.38	2.84	3.47	3.47	0.50	5.06	4.31	4.31	0.62	7.26	5.14	5.14	0.74	9.81	
	19	-	-	-	-	2.84	2.64	0.41	3.47	3.49	3.48	0.50	5.07	4.32	4.32	0.62	7.29	5.15	5.15	0.74	9.85	
	20	-	-	-	-	3.97	2.62	0.57	6.31	4.05	3.49	0.58	6.53	4.50	4.34	0.64	7.82	5.16	5.15	0.74	9.87	
13	3	15	2.19	2.19	0.63	7.56	3.04	3.04	0.87	13.03	3.89	3.89	1.12	20.20	4.71	4.71	1.35	27.80	5.54	5.54	1.58	36.83
		17	2.20	2.20	0.63	7.58	3.05	3.05	0.87	13.08	3.90	3.90	1.12	20.27	4.72	4.72	1.35	27.91	5.55	5.55	1.59	36.97
		19	-	-	-	-	3.86	3.06	1.11	19.90	4.05	3.94	1.16	21.59	4.73	4.73	1.35	28.02	5.56	5.56	1.59	37.12
		20	-	-	-	-	5.24	3.06	1.50	33.41	5.19	3.91	1.48	32.86	5.21	4.75	1.49	33.05	5.60	5.59	1.60	37.52
	4	15	1.75	1.75	0.38	2.91	2.61	2.61	0.56	6.14	3.46	3.46	0.74	9.92	4.31	4.31	0.93	14.57	5.13	5.13	1.11	19.67
		17	1.76	1.76	0.38	2.92	2.62	2.62	0.56	6.16	3.47	3.47	0.74	9.96	4.32	4.32	0.93	14.62	5.14	5.14	1.11	19.75
		19	-	-	-	-	2.81	2.65	0.60	6.93	3.48	3.47	0.75	10.01	4.33	4.33	0.93	14.68	5.15	5.15	1.11	19.83
		20	-	-	-	-	4.00	2.63	0.86	12.69	4.03	3.49	0.86	12.86	4.44	4.35	0.96	15.36	5.16	5.15	1.11	19.87
	5	15	1.34	1.34	0.23	0.86	2.18	2.18	0.37	2.86	3.04	3.04	0.52	5.41	3.88	3.88	0.67	8.20	4.71	4.71	0.81	11.42
		17	1.35	1.35	0.23	0.86	2.18	2.18	0.37	2.88	3.04	3.04	0.52	5.43	3.89	3.89	0.67	8.23	4.72	4.72	0.81	11.47
		19	-	-	-	-	2.19	2.18	0.38	2.91	3.05	3.05	0.52	5.45	3.90	3.90	0.67	8.27	4.73	4.73	0.81	11.51
		20	-	-	-	-	2.73	2.19	0.47	4.52	3.19	3.08	0.55	5.88	3.90	3.89	0.67	8.28	4.74	4.74	0.81	11.54
6	15	0.91	0.91	0.13	0.46	1.77	1.77	0.25	1.04	2.60	2.60	0.37	2.86	3.45	3.45	0.49	4.91	4.29	4.29	0.61	7.10	
	17	0.92	0.92	0.13	0.47	1.78	1.78	0.25	1.04	2.61	2.61	0.37	2.87	3.46	3.46	0.50	4.93	4.30	4.30	0.62	7.13	
	19	-	-	-	-	1.78	1.78	0.26	1.05	2.61	2.61	0.37	2.89	3.47	3.47	0.50	4.95	4.31	4.31	0.62	7.16	
	20	-	-	-	-	1.92	1.80	0.27	1.28	2.62	2.60	0.37	2.90	3.47	3.47	0.50	4.96	4.32	4.32	0.62	7.18	
15	3	15	-	-	-	-	2.18	2.18	0.62	7.30	3.04	3.04	0.87	12.82	3.88	3.88	1.11	19.79	4.70	4.70	1.34	27.25
		17	-	-	-	-	2.19	2.19	0.62	7.33	3.04	3.04	0.87	12.86	3.88	3.88	1.12	19.86	4.71	4.71	1.34	27.36
		19	-	-	-	-	2.19	2.18	0.63	7.35	3.05	3.05	0.87	12.92	3.89	3.89	1.12	19.94	4.72	4.72	1.35	27.47
		20	-	-	-	-	2.74	2.19	0.78	10.75	3.11	3.09	0.89	13.37	3.90	3.90	1.12	19.98	4.72	4.72	1.35	27.53
	4	15	-	-	-	-	1.75	1.75	0.37	2.92	2.61	2.61	0.56	6.04	3.46	3.46	0.75	9.87	4.29	4.29	0.92	14.27
		17	-	-	-	-	1.75	1.75	0.38	2.93	2.61	2.61	0.56	6.06	3.47	3.47	0.75	9.91	4.30	4.30	0.93	14.32
		19	-	-	-	-	1.76	1.76	0.38	2.95	2.62	2.62	0.56	6.09	3.48	3.48	0.75	9.95	4.31	4.31	0.93	14.38
		20	-	-	-	-	1.80	1.80	0.39	3.14	2.62	2.61	0.56	6.10	3.48	3.48	0.75	9.97	4.31	4.31	0.93	14.41
	5	15	0.47	0.47	0.08	0.28	1.34	1.34	0.23	0.85	2.18	2.18	0.38	2.95	3.03	3.03	0.52	5.35	3.87	3.87	0.67	8.11
		17	0.47	0.47	0.08	0.28	1.35	1.35	0.23	0.86	2.18	2.18	0.38	2.96	3.04	3.04	0.52	5.37	3.88	3.88	0.67	8.14
		19	-	-	-	-	1.35	1.35	0.23	0.86	2.19	2.19	0.38	2.98	3.05	3.05	0.53	5.39	3.89	3.89	0.67	8.17
		20	-	-	-	-	1.35	1.34	0.23	0.86	2.19	2.19	0.38	2.99	3.05	3.05	0.53	5.41	3.89	3.89	0.67	8.19
6	15	-	-	-	-	0.91	0.91	0.13	0.44	1.77	1.77	0.25	1.07	2.60	2.60	0.37	2.92	3.45	3.45	0.49	4.85	
	17	-	-	-	-	0.91	0.91	0.13	0.44	1.77	1.77	0.25	1.07	2.60	2.60	0.37	2.93	3.45	3.45	0.50	4.87	
	19	-	-	-	-	0.92	0.92	0.13	0.44	1.78	1.78	0.26	1.08	2.61	2.61	0.37	2.95	3.46	3.46	0.50	4.89	
	20	-	-	-	-	0.92	0.92	0.13	0.45	1.78	1.78	0.26	1.08	2.61	2.61	0.38	2.96	3.47	3.47	0.50	4.90	

Cooling capacity

MDVF-1000D303E																							
EWT	ΔT	Indoor temp (W.B.)	Indoor temperature (D.B.)																				
			21				23				25				27				29				
			TC	SC	WF	WPD	TC	SC	WF	WPD	TC	SC	WF	WPD	TC	SC	WF	WPD	TC	SC	WF	WPD	
°C	°C	°C	kW	kW	m³/h	kPa	kW	kW	m³/h	kPa	kW	kW	m³/h	kPa	kW	kW	m³/h	kPa	kW	kW	m³/h	kPa	
5	3	15	8.01	6.30	2.29	43.85	7.94	7.25	2.27	43.17	8.19	8.18	2.35	45.93	9.11	9.11	2.61	55.00	10.04	10.04	2.90	66.05	
		17	10.82	6.32	3.13	75.30	10.75	7.27	3.11	74.48	10.68	8.21	3.09	73.62	10.59	9.13	3.04	71.52	10.53	10.06	3.04	71.82	
		19	-	-	-	-	13.76	7.29	3.99	115.31	13.67	8.23	3.96	114.03	13.59	9.16	3.94	112.74	13.48	10.08	3.88	109.77	
		20	-	-	-	-	15.33	7.29	4.42	138.11	15.25	8.24	4.41	137.72	15.14	9.16	4.36	135.07	15.05	10.09	4.34	133.66	
	4	15	6.88	5.79	1.48	20.56	6.93	6.75	1.49	20.80	7.68	7.68	1.65	24.62	8.61	8.61	1.85	30.03	9.53	9.53	2.05	35.83	
		17	9.68	5.80	2.08	36.78	9.61	6.75	2.06	36.35	9.54	7.69	2.05	35.88	9.46	8.62	2.03	35.37	9.62	9.56	2.06	36.37	
		19	-	-	-	-	12.64	6.78	2.73	59.16	12.56	7.72	2.71	58.52	12.48	8.66	2.70	57.88	12.40	9.58	2.68	57.24	
		20	-	-	-	-	14.23	6.79	3.08	72.88	14.12	7.72	3.04	71.18	14.03	8.66	3.02	70.41	13.94	9.58	3.00	69.63	
	5	15	5.71	5.27	0.98	10.05	6.23	6.22	1.07	11.66	7.19	7.19	1.24	15.01	8.12	8.12	1.40	18.52	9.04	9.04	1.55	22.09	
		17	8.54	5.30	1.47	20.18	8.48	6.25	1.46	19.92	8.40	7.19	1.45	19.62	8.44	8.14	1.45	19.76	9.05	9.05	1.55	22.15	
		19	-	-	-	-	11.49	6.27	1.98	33.70	11.41	7.21	1.97	33.31	11.34	8.15	1.95	32.93	11.26	9.08	1.94	32.53	
		20	-	-	-	-	13.05	6.26	2.24	41.78	12.97	7.21	2.23	41.32	12.89	8.15	2.21	40.87	12.83	9.09	2.21	40.85	
	6	15	4.78	4.75	0.68	5.43	5.71	5.71	0.82	7.37	6.67	6.67	0.96	9.59	7.62	7.62	1.09	12.07	8.55	8.55	1.23	14.69	
		17	7.31	4.77	1.05	11.21	7.24	5.73	1.04	11.01	7.23	6.68	1.03	10.98	7.66	7.64	1.10	12.18	8.56	8.56	1.23	14.74	
		19	-	-	-	-	10.28	5.75	1.47	20.03	10.20	6.70	1.46	19.79	10.13	7.64	1.45	19.54	10.04	8.57	1.44	19.26	
		20	-	-	-	-	11.87	5.76	1.70	25.71	11.80	6.71	1.69	25.42	11.72	7.65	1.68	25.13	11.64	8.58	1.67	24.84	
	7	3	15	5.85	5.34	1.68	25.18	6.30	6.29	1.82	29.00	7.24	7.24	2.09	36.94	8.17	8.17	2.35	44.99	9.09	9.09	2.61	54.29
			17	8.69	5.36	2.51	50.74	8.60	6.30	2.47	49.24	8.52	7.25	2.45	48.46	8.49	8.18	2.44	48.12	9.11	9.11	2.62	54.46
			19	-	-	-	-	11.63	6.33	3.38	84.85	11.55	7.28	3.35	83.89	11.45	8.20	3.29	81.21	11.38	9.13	3.28	80.60
			20	-	-	-	-	13.20	6.33	3.81	104.85	13.11	7.27	3.78	103.65	13.03	8.21	3.76	102.48	12.96	9.15	3.76	102.38
		4	15	4.90	4.84	1.06	11.31	5.80	5.80	1.25	15.14	6.73	6.73	1.45	19.42	7.67	7.67	1.65	24.32	8.61	8.61	1.86	29.98
			17	7.47	4.84	1.61	23.23	7.40	5.79	1.59	22.85	7.35	6.74	1.58	22.59	7.70	7.69	1.66	24.50	8.62	8.62	1.87	30.07
			19	-	-	-	-	10.44	5.82	2.26	41.96	10.37	6.77	2.25	41.45	10.30	7.71	2.23	40.96	10.21	8.64	2.21	40.36
			20	-	-	-	-	12.03	5.83	2.61	53.73	11.95	6.78	2.59	53.12	11.87	7.72	2.57	52.50	11.80	8.65	2.55	51.91
5		15	4.31	4.30	0.74	6.15	5.28	5.28	0.91	8.68	6.23	6.23	1.07	11.53	7.17	7.17	1.23	14.69	8.10	8.10	1.39	18.09	
		17	6.21	4.32	1.07	11.47	6.16	5.28	1.06	11.29	6.38	6.25	1.10	12.01	7.19	7.19	1.24	14.74	8.12	8.12	1.40	18.14	
		19	-	-	-	-	9.20	5.30	1.58	22.51	9.13	6.25	1.57	22.22	8.84	7.03	1.59	48.20	8.99	8.13	1.55	21.63	
		20	-	-	-	-	10.81	5.32	1.87	30.02	10.74	6.27	1.86	29.67	10.67	7.22	1.84	29.32	10.59	8.15	1.83	28.94	
6		15	3.78	3.78	0.54	3.36	4.75	4.75	0.68	5.30	5.72	5.72	0.82	7.26	6.67	6.67	0.96	9.44	7.61	7.61	1.09	11.82	
		17	4.85	3.78	0.69	5.48	5.00	4.77	0.72	5.78	5.73	5.72	0.82	7.28	6.68	6.68	0.96	9.47	7.62	7.62	1.09	11.85	
		19	-	-	-	-	7.92	4.79	1.14	12.65	7.84	5.75	1.12	12.43	7.78	6.69	1.12	12.27	7.94	7.64	1.14	12.72	
		20	-	-	-	-	9.53	4.81	1.37	17.43	9.46	5.76	1.36	17.20	9.39	6.71	1.35	16.96	9.30	7.64	1.33	16.69	
9		3	15	4.38	4.38	1.26	15.10	5.33	5.33	1.53	21.16	6.29	6.29	1.82	28.53	7.22	7.22	2.07	35.79	8.16	8.16	2.36	44.89
			17	6.39	4.39	1.85	29.28	6.32	5.35	1.83	28.72	6.41	6.31	1.85	29.47	7.23	7.23	2.08	35.90	8.17	8.17	2.37	45.02
			19	-	-	-	-	9.31	5.35	2.68	55.89	9.25	6.30	2.66	55.22	9.17	7.24	2.64	54.44	9.09	8.17	2.62	53.58
			20	-	-	-	-	10.94	5.37	3.18	75.15	10.86	6.32	3.15	74.22	10.79	7.26	3.13	73.37	10.72	8.20	3.11	72.49
		4	15	3.86	3.86	0.83	7.38	4.83	4.83	1.04	10.82	5.78	5.78	1.24	14.74	6.73	6.73	1.45	19.23	7.67	7.67	1.66	24.18
			17	5.06	3.87	1.09	11.73	5.12	4.84	1.10	11.94	5.79	5.78	1.25	14.78	6.74	6.74	1.46	19.28	7.68	7.68	1.66	24.26
			19	-	-	-	-	8.08	4.85	1.75	26.49	8.01	5.81	1.73	26.08	7.94	6.75	1.72	25.67	7.99	7.70	1.73	25.98
			20	-	-	-	-	9.65	4.85	2.08	35.74	9.58	5.81	2.06	35.30	9.51	6.75	2.05	34.85	9.42	7.69	2.03	34.30
	5	15	3.33	3.33	0.57	3.83	4.31	4.31	0.74	6.07	5.28	5.28	0.91	8.56	6.23	6.23	1.07	11.36	7.17	7.17	1.24	14.52	
		17	3.72	3.33	0.64	4.73	4.33	4.33	0.75	6.11	5.29	5.29	0.91	8.59	6.24	6.24	1.07	11.39	7.19	7.19	1.24	14.56	
		19	-	-	-	-	6.74	4.34	1.16	12.98	6.67	5.29	1.15	12.75	6.71	6.25	1.15	12.89	7.23	7.21	1.25	14.70	
		20	-	-	-	-	8.35	4.35	1.44	18.80	8.29	5.31	1.43	18.53	8.20	6.25	1.41	18.21	8.15	7.19	1.40	18.02	
	6	15	2.86	2.86	0.41	1.65	3.79	3.79	0.54	3.42	4.77	4.77	0.68	5.25	5.73	5.73	0.82	7.17	6.67	6.67	0.96	9.30	
		17	2.92	2.87	0.42	1.74	3.79	3.79	0.54	3.44	4.78	4.78	0.68	5.27	5.74	5.74	0.82	7.19	6.69	6.69	0.96	9.33	
		19	-	-	-	-	5.32	3.81	0.76	6.31	5.34	4.78	0.77	6.37	5.83	5.76	0.84	7.39	6.70	6.70	0.96	9.36	
		20	-	-	-	-	6.98	3.84	1.00	10.03	6.90	4.80	0.99	9.84	6.85	5.75	0.98	9.72	7.05	6.71	1.01	10.21	

Continued:

MDVF-1000D303E																							
EWT	ΔT	Indoor temp (W.B.)	Indoor temperature (D.B.)																				
			21				23				25				27				29				
			TC	SC	WF	WPD	TC	SC	WF	WPD	TC	SC	WF	WPD	TC	SC	WF	WPD	TC	SC	WF	WPD	
°C	°C	°C	kW	kW	m³/h	kPa	kW	kW	m³/h	kPa	kW	kW	m³/h	kPa	kW	kW	m³/h	kPa	kW	kW	m³/h	kPa	
11	3	15	3.40	3.40	0.97	9.52	4.37	4.37	1.25	14.74	5.33	5.33	1.52	20.57	6.27	6.27	1.79	27.41	7.21	7.21	2.07	35.01	
		17	3.88	3.40	1.11	11.94	4.38	4.37	1.25	14.78	5.34	5.34	1.52	20.64	6.28	6.28	1.80	27.50	7.22	7.22	2.07	35.12	
		19	-	-	-	-	6.86	4.38	1.96	31.93	6.78	5.34	1.94	31.31	6.76	6.29	1.93	31.10	7.23	7.22	2.07	35.23	
		20	-	-	-	-	8.45	4.39	2.42	46.00	8.39	5.35	2.40	45.39	8.31	6.29	2.38	44.64	8.24	7.23	2.35	43.93	
	4	15	2.88	2.88	0.62	4.39	3.87	3.87	0.83	7.22	4.83	4.83	1.03	10.56	5.78	5.78	1.24	14.37	6.71	6.71	1.44	18.62	
		17	2.91	2.90	0.62	4.45	3.87	3.87	0.83	7.24	4.84	4.84	1.04	10.59	5.79	5.79	1.24	14.42	6.72	6.72	1.44	18.68	
		19	-	-	-	-	5.49	3.88	1.17	13.14	5.47	4.84	1.17	13.06	5.86	5.81	1.25	14.72	6.74	6.74	1.44	18.74	
		20	-	-	-	-	7.11	3.88	1.52	20.55	7.03	4.84	1.51	20.17	6.96	5.79	1.49	19.83	7.06	6.75	1.51	20.30	
	5	15	2.40	2.40	0.41	1.72	3.35	3.35	0.58	3.88	4.33	4.33	0.75	6.01	5.29	5.29	0.91	8.45	6.23	6.23	1.07	11.20	
		17	2.40	2.40	0.41	1.73	3.35	3.35	0.58	3.89	4.34	4.34	0.75	6.03	5.30	5.30	0.91	8.48	6.24	6.24	1.08	11.23	
		19	-	-	-	-	4.07	3.36	0.70	5.42	4.46	4.36	0.77	6.33	5.31	5.30	0.91	8.51	6.25	6.25	1.08	11.27	
		20	-	-	-	-	5.69	3.38	0.98	9.59	5.63	4.34	0.97	9.41	5.73	5.31	0.99	9.70	6.29	6.27	1.08	11.39	
	6	15	1.96	1.96	0.28	0.74	2.86	2.86	0.41	1.72	3.80	3.80	0.55	3.49	4.77	4.77	0.68	5.14	5.73	5.73	0.82	7.02	
		17	1.96	1.96	0.28	0.74	2.87	2.87	0.41	1.73	3.81	3.81	0.55	3.50	4.78	4.78	0.68	5.16	5.74	5.74	0.82	7.04	
		19	-	-	-	-	2.99	2.87	0.43	1.94	3.82	3.81	0.55	3.51	4.79	4.79	0.68	5.18	5.75	5.75	0.82	7.06	
		20	-	-	-	-	4.13	2.84	0.59	4.04	4.23	3.83	0.61	4.23	4.84	4.80	0.69	5.28	5.75	5.75	0.82	7.08	
	13	3	15	2.43	2.43	0.70	5.35	3.41	3.41	0.98	9.52	4.36	4.36	1.24	14.36	5.32	5.32	1.53	20.51	6.25	6.25	1.79	26.99
			17	2.44	2.44	0.70	5.37	3.41	3.41	0.98	9.55	4.37	4.37	1.25	14.41	5.33	5.33	1.53	20.57	6.27	6.27	1.80	27.07
			19	-	-	-	-	4.18	3.40	1.19	13.33	4.46	4.40	1.28	15.13	5.34	5.34	1.54	20.64	6.28	6.28	1.80	27.09
			20	-	-	-	-	5.82	3.42	1.67	23.95	5.75	4.38	1.65	23.44	5.76	5.34	1.66	23.53	6.28	6.27	1.80	27.09
		4	15	1.92	1.92	0.41	1.78	2.89	2.89	0.62	4.39	3.86	3.86	0.83	7.10	4.82	4.82	1.03	10.39	5.78	5.78	1.25	14.32
			17	1.92	1.92	0.41	1.78	2.90	2.90	0.62	4.41	3.87	3.87	0.83	7.13	4.83	4.83	1.03	10.42	5.78	5.78	1.24	14.17
			19	-	-	-	-	3.00	2.92	0.65	4.67	3.87	3.86	0.83	7.14	4.84	4.84	1.04	10.45	5.80	5.80	1.25	14.39
			20	-	-	-	-	4.30	2.90	0.92	8.55	4.34	3.88	0.93	8.66	4.88	4.86	1.05	10.60	5.79	5.79	1.24	14.24
5		15	1.47	1.47	0.25	0.64	2.39	2.39	0.41	1.75	3.35	3.35	0.57	3.81	4.32	4.32	0.74	5.87	5.28	5.28	0.91	8.25	
		17	1.47	1.47	0.25	0.64	2.39	2.39	0.41	1.76	3.36	3.36	0.58	3.82	4.33	4.33	0.74	5.89	5.29	5.29	0.91	8.27	
		19	-	-	-	-	2.39	2.38	0.41	1.77	3.36	3.36	0.58	3.83	4.34	4.34	0.74	5.91	5.30	5.30	0.91	8.30	
		20	-	-	-	-	2.76	2.37	0.47	2.57	3.40	3.38	0.58	3.91	4.34	4.34	0.75	5.92	5.30	5.30	0.91	8.32	
6		15	1.00	1.00	0.14	0.36	1.96	1.96	0.28	0.71	2.86	2.86	0.41	1.77	3.81	3.81	0.55	3.46	4.78	4.78	0.68	5.09	
		17	1.00	1.00	0.14	0.36	1.96	1.96	0.28	0.71	2.86	2.86	0.41	1.78	3.82	3.82	0.55	3.47	4.79	4.79	0.69	5.11	
		19	-	-	-	-	1.96	1.96	0.28	0.72	2.87	2.87	0.41	1.79	3.83	3.83	0.55	3.48	4.80	4.80	0.69	5.12	
		20	-	-	-	-	2.04	1.98	0.29	0.76	2.87	2.86	0.41	1.79	3.83	3.83	0.55	3.49	4.80	4.80	0.69	5.13	
15		3	15	1.44	1.44	0.41	1.79	2.43	2.43	0.69	5.19	3.40	3.40	0.97	9.23	4.36	4.36	1.24	14.15	5.31	5.31	1.53	20.16
			17	1.44	1.44	0.41	1.80	2.43	2.43	0.69	5.21	3.41	3.41	0.97	9.26	4.37	4.37	1.26	14.42	5.32	5.32	1.53	20.22
			19	-	-	-	-	2.43	2.43	0.69	5.22	3.41	3.41	0.97	9.29	4.38	4.38	1.26	14.47	5.33	5.33	1.53	20.29
			20	-	-	-	-	2.93	2.43	0.84	7.15	3.43	3.43	0.98	9.38	4.39	4.39	1.26	14.50	5.33	5.33	1.53	20.32
		4	15	0.99	0.99	0.21	0.52	1.92	1.92	0.41	1.81	2.89	2.89	0.62	4.29	3.86	3.86	0.83	7.02	4.83	4.83	1.04	10.36
			17	0.99	0.99	0.21	0.52	1.92	1.92	0.41	1.82	2.90	2.90	0.62	4.31	3.87	3.87	0.83	7.04	4.84	4.84	1.04	10.39
			19	-	-	-	-	1.92	1.92	0.41	1.83	2.91	2.91	0.62	4.32	3.88	3.88	0.83	7.06	4.84	4.84	1.04	10.43
			20	-	-	-	-	1.93	1.92	0.41	1.86	2.91	2.91	0.62	4.33	3.88	3.88	0.83	7.07	4.85	4.85	1.05	10.45
	5	15	0.52	0.52	0.09	0.21	1.48	1.48	0.26	0.62	2.39	2.39	0.41	1.86	3.37	3.37	0.58	3.81	4.33	4.33	0.75	5.85	
		17	0.52	0.52	0.09	0.21	1.49	1.49	0.26	0.62	2.40	2.40	0.41	1.87	3.37	3.37	0.58	3.82	4.34	4.34	0.75	5.87	
		19	-	-	-	-	1.49	1.49	0.26	0.62	2.40	2.40	0.41	1.87	3.38	3.38	0.58	3.84	4.35	4.35	0.75	5.89	
		20	-	-	-	-	1.49	1.48	0.26	0.62	2.41	2.41	0.41	1.88	3.38	3.38	0.58	3.84	4.35	4.35	0.75	5.90	
	6	15	-	-	-	-	1.01	1.01	0.14	0.34	1.96	1.96	0.28	0.71	2.86	2.86	0.41	1.86	3.83	3.83	0.55	3.46	
		17	-	-	-	-	1.01	1.01	0.15	0.34	1.97	1.97	0.28	0.71	2.87	2.87	0.41	1.86	3.83	3.83	0.55	3.47	
		19	-	-	-	-	1.01	1.01	0.15	0.34	1.97	1.97	0.28	0.71	2.87	2.87	0.41	1.87	3.84	3.84	0.55	3.48	
		20	-	-	-	-	1.01	1.01	0.15	0.34	1.97	1.97	0.28	0.71	2.87	2.87	0.41	1.88	3.84	3.84	0.55	3.49	

Cooling capacity

MDVF-1200D303E																						
EWT	ΔT	Indoor temp (W.B.)	Indoor temperature (D.B.)																			
			21				23				25				27				29			
			TC	SC	WF	WPD	TC	SC	WF	WPD	TC	SC	WF	WPD	TC	SC	WF	WPD	TC	SC	WF	WPD
°C	°C	°C	kW	kW	m ³ /h	kPa	kW	kW	m ³ /h	kPa	kW	kW	m ³ /h	kPa	kW	kW	m ³ /h	kPa	kW	kW	m ³ /h	kPa
5	3	15	9.71	7.64	2.79	45.49	9.61	8.78	2.75	44.38	9.93	9.92	2.86	47.58	11.04	11.04	3.16	56.56	12.16	12.16	3.51	67.74
		17	13.11	7.66	3.79	77.44	13.03	8.81	3.76	76.57	12.94	9.95	3.74	75.71	12.85	11.07	3.71	74.76	12.76	12.18	3.68	73.81
		19	-	-	-	-	16.65	8.82	4.81	117.90	16.56	9.97	4.80	117.28	16.46	11.10	4.77	116.04	16.36	12.22	4.74	114.76
		20	-	-	-	-	18.59	8.84	5.41	144.46	18.47	9.98	5.34	141.59	18.36	11.11	5.30	139.76	18.24	12.22	5.26	137.83
	4	15	8.33	7.01	1.80	21.13	8.39	8.18	1.81	21.39	9.30	9.30	1.99	25.32	10.43	10.43	2.24	30.88	11.55	11.55	2.48	36.84
		17	11.72	7.02	2.51	37.80	11.64	8.18	2.50	37.36	11.56	9.32	2.48	36.90	11.46	10.45	2.46	36.36	11.65	11.58	2.50	37.40
		19	-	-	-	-	15.31	8.21	3.31	60.81	15.20	9.35	3.28	59.81	15.12	10.48	3.27	59.49	15.02	11.60	3.24	58.85
		20	-	-	-	-	17.24	8.22	3.73	74.92	17.13	9.36	3.70	74.11	17.03	10.50	3.68	73.33	16.92	11.62	3.66	72.53
	5	15	6.91	6.38	1.19	10.33	7.54	7.53	1.29	11.99	8.71	8.71	1.50	15.43	9.84	9.84	1.69	19.04	10.94	10.94	1.88	22.70
		17	10.34	6.41	1.78	20.74	10.27	7.57	1.77	20.48	10.17	8.71	1.75	20.16	10.22	9.86	1.76	20.32	10.96	10.96	1.88	22.77
		19	-	-	-	-	13.91	7.59	2.40	34.63	13.82	8.74	2.38	34.24	13.73	9.87	2.37	33.86	13.63	10.99	2.35	33.45
		20	-	-	-	-	15.81	7.59	2.72	42.94	15.71	8.73	2.70	42.47	15.61	9.87	2.68	42.00	15.51	11.00	2.66	41.54
6	15	5.79	5.75	0.83	5.59	6.92	6.92	0.99	7.58	8.08	8.08	1.16	9.86	9.23	9.23	1.32	12.40	10.35	10.35	1.49	15.10	
	17	8.87	5.79	1.27	11.59	8.77	6.94	1.26	11.32	8.75	8.09	1.25	11.29	9.28	9.25	1.33	12.53	10.37	10.37	1.49	15.15	
	19	-	-	-	-	12.45	6.96	1.78	20.59	12.36	8.11	1.77	20.34	12.27	9.25	1.75	20.09	12.16	10.37	1.74	19.79	
	20	-	-	-	-	14.38	6.98	2.06	26.43	14.29	8.13	2.04	26.13	14.19	9.27	2.03	25.83	14.10	10.39	2.02	25.53	
7	3	15	7.09	6.46	2.03	25.88	7.63	7.62	2.21	29.80	8.77	8.77	2.54	37.98	9.89	9.89	2.84	46.27	11.01	11.01	3.17	55.83
		17	10.51	6.48	3.03	51.71	10.44	7.64	3.01	51.25	10.32	8.78	2.97	49.83	10.28	9.91	2.96	49.51	11.04	11.04	3.19	56.40
		19	-	-	-	-	14.08	7.66	4.09	87.23	13.99	8.81	4.06	86.22	13.90	9.95	4.04	85.29	13.81	11.07	4.01	84.30
		20	-	-	-	-	15.98	7.66	4.62	107.87	15.88	8.81	4.59	106.64	15.78	9.95	4.56	105.46	15.68	11.07	4.53	104.28
	4	15	5.95	5.87	1.29	11.71	7.02	7.02	1.52	15.56	8.15	8.15	1.75	19.96	9.29	9.29	2.00	25.01	10.43	10.43	2.26	30.82
		17	9.05	5.86	1.95	23.89	8.96	7.02	1.93	23.49	8.90	8.16	1.91	23.22	9.33	9.32	2.01	25.20	10.44	10.44	2.26	30.91
		19	-	-	-	-	12.65	7.05	2.74	43.12	12.56	8.20	2.72	42.62	12.47	9.33	2.70	42.11	12.37	10.46	2.68	41.50
		20	-	-	-	-	14.57	7.05	3.16	55.23	14.47	8.21	3.14	54.61	14.38	9.35	3.12	54.00	14.29	10.47	3.10	53.39
	5	15	5.22	5.21	0.90	6.32	6.39	6.39	1.10	8.93	7.55	7.55	1.30	11.85	8.69	8.69	1.50	15.12	9.81	9.81	1.69	18.60
		17	7.52	5.23	1.29	11.79	7.46	6.39	1.28	11.60	7.73	7.57	1.33	12.36	8.71	8.71	1.50	15.17	9.83	9.83	1.69	18.66
		19	-	-	-	-	11.14	6.42	1.92	23.14	11.06	7.57	1.90	22.84	10.98	8.67	1.98	48.91	10.89	9.84	1.87	22.24
		20	-	-	-	-	13.10	6.44	2.26	30.86	13.01	7.60	2.25	30.50	12.92	8.74	2.23	30.14	12.82	9.87	2.22	29.74
6	15	4.58	4.58	0.66	3.48	5.75	5.75	0.82	5.45	6.93	6.93	0.99	7.47	8.08	8.08	1.16	9.70	9.22	9.22	1.32	12.15	
	17	5.87	4.58	0.84	5.64	6.06	5.77	0.87	5.95	6.94	6.93	0.99	7.49	8.10	8.10	1.16	9.73	9.23	9.23	1.32	12.18	
	19	-	-	-	-	9.63	5.82	1.38	13.16	9.50	6.96	1.36	12.79	9.42	8.10	1.35	12.61	9.63	9.26	1.38	13.08	
	20	-	-	-	-	11.55	5.82	1.66	17.94	11.47	6.98	1.65	17.71	11.37	8.12	1.63	17.45	11.27	9.25	1.62	17.17	
9	3	15	5.30	5.30	1.53	15.56	6.46	6.46	1.85	21.75	7.62	7.62	2.20	29.33	8.74	8.74	2.51	36.80	9.88	9.88	2.86	46.14
		17	7.73	5.31	2.24	30.08	7.65	6.48	2.21	29.53	7.77	7.65	2.25	30.31	8.76	8.76	2.52	36.91	9.90	9.90	2.87	46.28
		19	-	-	-	-	11.28	6.48	3.25	57.51	11.20	7.63	3.22	56.77	11.11	8.77	3.20	55.96	11.01	9.90	3.17	55.11
		20	-	-	-	-	13.23	6.50	3.83	76.63	13.15	7.65	3.81	75.98	13.07	8.80	3.79	75.44	12.97	9.93	3.77	74.53
	4	15	4.67	4.67	1.01	7.59	5.85	5.85	1.26	11.12	7.01	7.01	1.51	15.16	8.15	8.15	1.76	19.76	9.28	9.28	2.01	24.87
		17	6.13	4.68	1.32	12.05	6.20	5.86	1.33	12.28	7.02	7.00	1.51	15.20	8.17	8.17	1.76	19.82	9.30	9.30	2.01	24.94
		19	-	-	-	-	9.79	5.88	2.12	27.24	9.70	7.03	2.10	26.82	9.61	8.18	2.08	26.38	9.68	9.32	2.10	26.73
		20	-	-	-	-	11.69	5.88	2.52	36.75	11.61	7.04	2.50	36.31	11.52	8.18	2.48	35.83	11.42	9.31	2.46	35.26
	5	15	4.03	4.03	0.69	3.95	5.23	5.23	0.90	6.24	6.40	6.40	1.10	8.80	7.55	7.55	1.30	11.68	8.69	8.69	1.50	14.92
		17	4.51	4.04	0.78	4.86	5.25	5.25	0.90	6.28	6.41	6.41	1.10	8.83	7.56	7.56	1.30	11.71	8.70	8.70	1.50	14.97
		19	-	-	-	-	8.16	5.25	1.40	13.35	8.07	6.41	1.39	13.10	8.13	7.57	1.40	13.26	8.75	8.73	1.51	15.12
		20	-	-	-	-	10.12	5.27	1.74	19.32	10.04	6.43	1.73	19.06	9.94	7.58	1.71	18.73	9.87	8.71	1.70	18.53
6	15	3.46	3.46	0.50	1.71	4.59	4.59	0.66	3.54	5.77	5.77	0.83	5.40	6.94	6.94	1.00	7.37	8.08	8.08	1.16	9.57	
	17	3.54	3.48	0.51	1.81	4.59	4.59	0.66	3.55	5.79	5.79	0.83	5.42	6.95	6.95	1.00	7.40	8.10	8.10	1.16	9.60	
	19	-	-	-	-	6.44	4.62	0.92	6.49	6.48	5.79	0.93	6.55	7.07	6.98	1.01	7.61	8.11	8.11	1.16	9.63	
	20	-	-	-	-	8.45	4.65	1.21	10.31	8.36	5.81	1.20	10.12	8.30	6.96	1.19	9.99	8.54	8.13	1.23	10.51	

Continued:

MDVF-1200D303E																							
EWT	ΔT	Indoor temp (W.B.)	Indoor temperature (D.B.)																				
			21				23				25				27				29				
			TC	SC	WF	WPD	TC	SC	WF	WPD	TC	SC	WF	WPD	TC	SC	WF	WPD	TC	SC	WF	WPD	
°C	°C	°C	kW	kW	m³/h	kPa	kW	kW	m³/h	kPa	kW	kW	m³/h	kPa	kW	kW	m³/h	kPa	kW	kW	m³/h	kPa	
11	3	15	4.12	4.12	1.18	9.79	5.30	5.30	1.52	15.15	6.45	6.45	1.84	21.15	7.60	7.60	2.18	28.27	8.73	8.73	2.50	36.00	
		17	4.71	4.12	1.34	12.27	5.31	5.29	1.52	15.20	6.46	6.46	1.84	21.21	7.61	7.61	2.18	28.36	8.74	8.74	2.51	36.11	
		19	-	-	-	-	8.31	5.31	2.37	32.83	8.22	6.47	2.35	32.21	8.19	7.62	2.34	32.01	8.76	8.75	2.51	36.23	
		20	-	-	-	-	10.24	5.31	2.93	47.29	10.17	6.48	2.91	46.69	10.07	7.62	2.88	45.93	9.98	8.76	2.85	45.19	
	4	15	3.49	3.49	0.75	4.51	4.68	4.68	1.00	7.42	5.85	5.85	1.25	10.86	7.00	7.00	1.50	14.78	8.13	8.13	1.74	19.15	
		17	3.52	3.52	0.75	4.58	4.69	4.69	1.00	7.45	5.86	5.86	1.25	10.89	7.01	7.01	1.50	14.82	8.15	8.15	1.75	19.20	
		19	-	-	-	-	6.64	4.69	1.42	13.51	6.62	5.86	1.42	13.43	7.10	7.04	1.52	15.14	8.16	8.16	1.75	19.27	
		20	-	-	-	-	8.61	4.70	1.84	21.12	8.52	5.87	1.83	20.74	8.44	7.02	1.81	20.40	8.55	8.18	1.83	20.88	
	5	15	2.90	2.90	0.50	1.79	4.06	4.06	0.70	3.99	5.24	5.24	0.90	6.18	6.40	6.40	1.10	8.69	7.55	7.55	1.30	11.51	
		17	2.91	2.90	0.50	1.79	4.06	4.06	0.70	4.00	5.25	5.25	0.90	6.20	6.42	6.42	1.10	8.72	7.56	7.56	1.30	11.55	
		19	-	-	-	-	4.93	4.07	0.85	5.56	5.41	5.28	0.93	6.51	6.43	6.42	1.11	8.74	7.58	7.58	1.30	11.59	
		20	-	-	-	-	6.90	4.09	1.19	9.86	6.82	5.26	1.18	9.68	6.95	6.43	1.20	9.98	7.63	7.59	1.31	11.72	
	6	15	2.37	2.37	0.34	0.76	3.47	3.47	0.50	1.79	4.61	4.61	0.66	3.59	5.78	5.78	0.83	5.29	6.94	6.94	0.99	7.22	
		17	2.38	2.38	0.34	0.76	3.47	3.47	0.50	1.80	4.62	4.62	0.66	3.61	5.79	5.79	0.83	5.31	6.95	6.95	0.99	7.24	
		19	-	-	-	-	3.62	3.48	0.52	2.02	4.62	4.61	0.66	3.62	5.80	5.80	0.83	5.33	6.96	6.96	1.00	7.26	
		20	-	-	-	-	5.00	3.43	0.72	4.17	5.13	4.64	0.74	4.35	5.87	5.82	0.84	5.44	6.97	6.97	1.00	7.28	
	13	3	15	2.94	2.94	0.85	5.50	4.13	4.13	1.19	9.79	5.29	5.29	1.52	15.01	6.44	6.44	1.85	21.09	7.57	7.57	2.16	27.54
			17	2.95	2.95	0.85	5.52	4.14	4.14	1.19	9.82	5.30	5.30	1.52	15.06	6.46	6.46	1.86	21.15	7.58	7.58	2.17	27.63
			19	-	-	-	-	5.06	4.12	1.44	13.71	5.41	5.33	1.55	15.57	6.47	6.47	1.86	21.22	7.60	7.60	2.17	27.72
			20	-	-	-	-	7.05	4.14	2.03	24.63	6.96	5.31	2.00	24.10	6.98	6.47	2.01	24.19	7.60	7.59	2.17	27.77
		4	15	2.33	2.33	0.50	1.84	3.51	3.51	0.75	4.52	4.68	4.68	1.00	7.31	5.84	5.84	1.25	10.68	7.00	7.00	1.51	14.71
			17	2.33	2.33	0.50	1.85	3.51	3.51	0.76	4.53	4.69	4.69	1.00	7.33	5.85	5.85	1.25	10.71	7.01	7.01	1.51	14.75
			19	-	-	-	-	3.64	3.54	0.78	4.81	4.69	4.68	1.01	7.35	5.86	5.86	1.26	10.75	7.02	7.02	1.51	14.80
			20	-	-	-	-	5.21	3.51	1.12	8.79	5.26	4.70	1.13	8.91	5.91	5.88	1.27	10.91	7.03	7.03	1.51	14.83
5		15	1.78	1.78	0.31	0.66	2.89	2.89	0.50	1.82	4.06	4.06	0.70	3.92	5.24	5.24	0.90	6.04	6.39	6.39	1.10	8.48	
		17	1.79	1.79	0.31	0.66	2.90	2.90	0.50	1.83	4.07	4.07	0.70	3.93	5.25	5.25	0.90	6.06	6.40	6.40	1.10	8.51	
		19	-	-	-	-	2.90	2.88	0.50	1.83	4.07	4.07	0.70	3.94	5.26	5.26	0.90	6.08	6.42	6.42	1.10	8.54	
		20	-	-	-	-	3.34	2.87	0.57	2.66	4.13	4.10	0.71	4.03	5.26	5.26	0.90	6.09	6.42	6.42	1.10	8.55	
6		15	1.22	1.22	0.17	0.36	2.37	2.37	0.34	0.73	3.46	3.46	0.50	1.83	4.62	4.62	0.66	3.56	5.79	5.79	0.83	5.23	
		17	1.22	1.22	0.17	0.37	2.38	2.38	0.34	0.73	3.47	3.47	0.50	1.84	4.63	4.63	0.66	3.57	5.80	5.80	0.83	5.25	
		19	-	-	-	-	2.38	2.38	0.34	0.74	3.47	3.47	0.50	1.85	4.64	4.64	0.66	3.58	5.81	5.81	0.83	5.27	
		20	-	-	-	-	2.48	2.39	0.35	0.79	3.48	3.47	0.50	1.86	4.64	4.64	0.66	3.59	5.82	5.82	0.83	5.28	
15		3	15	1.74	1.74	0.50	1.86	2.94	2.94	0.84	5.34	4.12	4.12	1.18	9.49	5.29	5.29	1.52	14.79	6.43	6.43	1.85	20.73
			17	1.75	1.75	0.50	1.87	2.94	2.94	0.84	5.35	4.13	4.13	1.18	9.52	5.30	5.30	1.52	14.83	6.44	6.44	1.85	20.79
			19	-	-	-	-	2.95	2.94	0.84	5.37	4.13	4.13	1.18	9.55	5.31	5.31	1.53	14.88	6.45	6.45	1.86	20.86
			20	-	-	-	-	3.55	2.95	1.01	7.36	4.16	4.15	1.19	9.65	5.32	5.32	1.53	14.91	6.46	6.46	1.86	20.89
		4	15	1.20	1.20	0.26	0.53	2.32	2.32	0.50	1.88	3.51	3.51	0.75	4.41	4.68	4.68	1.00	7.21	5.85	5.85	1.26	10.65
			17	1.21	1.21	0.26	0.54	2.33	2.33	0.50	1.89	3.51	3.51	0.75	4.43	4.69	4.69	1.01	7.24	5.86	5.86	1.26	10.69
			19	-	-	-	-	2.33	2.33	0.50	1.90	3.52	3.52	0.75	4.44	4.70	4.70	1.01	7.26	5.87	5.87	1.26	10.72
			20	-	-	-	-	2.34	2.33	0.50	1.93	3.52	3.52	0.76	4.45	4.70	4.70	1.01	7.27	5.87	5.87	1.27	10.74
	5	15	0.63	0.63	0.11	0.22	1.80	1.80	0.31	0.63	2.90	2.90	0.50	1.93	4.08	4.08	0.70	3.92	5.25	5.25	0.90	6.01	
		17	0.63	0.63	0.11	0.22	1.80	1.80	0.31	0.64	2.91	2.91	0.50	1.93	4.09	4.09	0.70	3.93	5.26	5.26	0.91	6.03	
		19	-	-	-	-	1.81	1.81	0.31	0.64	2.91	2.91	0.50	1.94	4.09	4.09	0.71	3.94	5.27	5.27	0.91	6.05	
		20	-	-	-	-	1.81	1.80	0.31	0.64	2.91	2.91	0.50	1.95	4.10	4.10	0.71	3.95	5.27	5.27	0.91	6.06	
	6	15	-	-	-	-	1.22	1.22	0.18	0.35	2.38	2.38	0.34	0.73	3.47	3.47	0.50	1.92	4.64	4.64	0.67	3.56	
		17	-	-	-	-	1.23	1.23	0.18	0.35	2.38	2.38	0.34	0.73	3.47	3.47	0.50	1.93	4.64	4.64	0.67	3.57	
		19	-	-	-	-	1.23	1.23	0.18	0.35	2.39	2.39	0.34	0.73	3.48	3.48	0.50	1.94	4.65	4.65	0.67	3.58	
		20	-	-	-	-	1.23	1.23	0.18	0.35	2.39	2.39	0.34	0.74	3.48	3.48	0.50	1.95	4.66	4.66	0.67	3.59	

Cooling capacity

MDVF-1400D303E																						
EWT	ΔT	Indoor temp (W.B.)	Indoor temperature (D.B.)																			
			21				23				25				27				29			
			TC	SC	WF	WPD	TC	SC	WF	WPD	TC	SC	WF	WPD	TC	SC	WF	WPD	TC	SC	WF	WPD
°C	°C	°C	kW	kW	m³/h	kPa	kW	kW	m³/h	kPa	kW	kW	m³/h	kPa	kW	kW	m³/h	kPa	kW	kW	m³/h	kPa
5	3	15	11.87	9.28	3.40	70.73	11.77	10.66	3.37	69.65	12.09	12.05	3.49	73.98	13.39	13.39	3.87	88.53	14.73	14.73	4.27	105.00
		17	15.95	9.30	4.59	119.41	15.84	10.68	4.56	118.01	15.77	12.07	4.56	117.91	15.65	13.41	4.54	116.97	15.55	14.75	4.51	115.64
		19	-	-	-	-	20.22	10.71	5.83	181.82	20.09	12.08	5.80	179.81	19.97	13.43	5.76	177.83	19.84	14.77	5.73	175.94
		20	-	-	-	-	22.54	10.72	6.50	220.17	22.41	12.09	6.46	217.80	22.27	13.45	6.42	215.41	22.13	14.79	6.38	213.10
	4	15	10.27	8.55	2.20	33.09	10.34	9.95	2.22	33.50	11.33	11.32	2.44	39.40	12.68	12.68	2.72	47.73	14.03	14.03	3.03	57.50
		17	14.40	8.59	3.10	59.86	14.31	9.98	3.09	59.55	14.21	11.35	3.07	58.77	14.10	12.70	3.04	57.96	14.29	14.06	3.09	59.37
		19	-	-	-	-	18.66	9.99	4.02	94.04	18.54	11.36	3.99	92.95	18.44	12.73	3.99	92.72	18.34	14.08	3.97	92.03
		20	-	-	-	-	20.98	10.00	4.52	115.73	20.86	11.38	4.50	114.78	20.75	12.76	4.50	114.59	20.63	14.11	4.47	113.30
	5	15	8.72	7.85	1.50	17.01	9.32	9.26	1.61	19.10	10.61	10.61	1.82	23.69	11.99	11.99	2.07	29.46	13.33	13.33	2.30	35.40
		17	12.79	7.87	2.20	32.93	12.69	9.26	2.19	32.48	12.57	10.63	2.17	31.99	12.64	12.00	2.18	32.29	13.36	13.36	2.30	35.58
		19	-	-	-	-	17.05	9.27	2.93	53.93	16.94	10.65	2.91	53.31	16.82	12.01	2.89	52.69	16.70	13.36	2.87	52.05
		20	-	-	-	-	19.40	9.30	3.34	67.86	19.27	10.68	3.32	67.10	19.14	12.04	3.30	66.31	19.02	13.39	3.27	65.46
6	15	7.39	7.12	1.06	9.32	8.53	8.53	1.22	11.93	9.91	9.91	1.42	15.43	11.27	11.27	1.61	19.11	12.62	12.62	1.81	23.22	
	17	11.05	7.13	1.58	18.47	10.94	8.52	1.57	18.16	10.95	9.91	1.57	18.18	11.49	11.29	1.64	19.76	12.64	12.64	1.81	23.29	
	19	-	-	-	-	15.42	8.57	2.21	33.01	15.31	9.95	2.20	32.62	15.19	11.32	2.18	32.18	15.07	12.67	2.16	31.74	
	20	-	-	-	-	17.74	8.58	2.55	42.14	17.62	9.97	2.53	41.64	17.51	11.33	2.51	41.16	17.39	12.69	2.50	40.68	
7	3	15	8.73	7.86	2.51	40.94	9.27	9.27	2.66	45.51	10.64	10.64	3.07	58.27	12.01	12.01	3.48	72.54	13.35	13.35	3.88	87.47
		17	12.83	7.89	3.70	80.49	12.74	9.28	3.67	79.45	12.62	10.65	3.64	78.17	12.58	12.01	3.62	77.74	13.36	13.36	3.88	87.62
		19	-	-	-	-	17.12	9.30	4.96	134.71	17.04	10.69	4.96	134.72	16.93	12.06	4.94	133.56	16.78	13.39	4.86	129.78
		20	-	-	-	-	19.47	9.33	5.68	171.09	19.35	10.71	5.65	169.25	19.23	12.07	5.61	167.35	19.10	13.42	5.57	165.39
	4	15	7.38	7.17	1.59	18.51	8.55	8.55	1.84	23.86	9.95	9.95	2.15	31.27	11.29	11.29	2.43	38.61	12.66	12.66	2.74	47.55
		17	11.15	7.16	2.40	37.77	11.04	8.55	2.38	37.11	10.98	9.93	2.36	36.77	11.46	11.34	2.48	40.03	12.68	12.68	2.75	47.70
		19	-	-	-	-	15.45	8.58	3.33	66.80	15.34	9.96	3.31	65.98	15.23	11.33	3.28	65.12	15.11	12.68	3.26	64.32
		20	-	-	-	-	17.78	8.60	3.84	85.51	17.66	9.98	3.81	84.52	17.56	11.35	3.80	84.04	17.46	12.72	3.79	83.64
	5	15	6.44	6.44	1.11	9.95	7.84	7.84	1.35	13.92	9.22	9.22	1.59	18.40	10.60	10.60	1.82	23.36	11.96	11.96	2.07	29.03
		17	9.39	6.44	1.62	18.96	9.32	7.84	1.60	18.71	9.63	9.25	1.66	19.81	10.61	10.61	1.83	23.43	11.98	11.98	2.07	29.12
		19	-	-	-	-	13.74	7.87	2.37	36.62	13.64	9.25	2.35	36.15	13.53	11.24	2.44	58.90	13.44	11.98	2.31	35.24
		20	-	-	-	-	16.09	7.89	2.78	48.62	15.99	9.28	2.77	48.06	15.88	10.65	2.75	47.48	15.75	12.01	2.72	46.82
6	15	5.69	5.69	0.82	5.88	7.12	7.12	1.02	8.60	8.52	8.52	1.22	11.68	9.89	9.89	1.42	15.10	11.26	11.26	1.62	18.91	
	17	7.54	5.70	1.08	9.48	7.76	7.13	1.11	9.95	8.59	8.54	1.23	11.86	9.91	9.91	1.42	15.15	11.28	11.28	1.62	18.97	
	19	-	-	-	-	11.96	7.15	1.72	20.97	11.85	8.54	1.70	20.62	11.77	9.92	1.69	20.39	12.01	11.30	1.72	21.11	
	20	-	-	-	-	14.28	7.16	2.05	28.38	14.17	8.55	2.03	28.02	14.09	9.94	2.03	27.92	13.97	11.30	2.01	27.50	
9	3	15	6.46	6.45	1.86	23.95	7.86	7.86	2.26	33.63	9.25	9.25	2.68	45.31	10.60	10.60	3.05	56.78	11.97	11.97	3.47	71.11
		17	9.50	6.48	2.75	47.41	9.40	7.87	2.72	46.57	9.54	9.28	2.76	47.79	10.62	10.62	3.06	56.97	11.99	11.99	3.47	71.15
		19	-	-	-	-	13.82	7.90	4.02	91.87	13.72	9.29	3.99	90.71	13.61	10.66	3.96	89.41	13.50	12.02	3.91	87.54
		20	-	-	-	-	16.11	7.90	4.66	119.15	16.00	9.28	4.63	117.64	15.91	10.67	4.63	117.63	15.81	12.03	4.61	116.69
	4	15	5.75	5.75	1.24	11.88	7.16	7.16	1.54	17.35	8.55	8.55	1.85	23.74	9.91	9.91	2.13	30.34	11.26	11.26	2.43	37.94
		17	7.67	5.75	1.65	19.56	7.75	7.17	1.67	19.94	8.58	8.58	1.86	23.89	9.92	9.92	2.14	30.44	11.28	11.28	2.43	38.06
		19	-	-	-	-	12.05	7.19	2.61	43.07	11.94	8.58	2.59	42.41	11.84	9.95	2.56	41.74	11.93	11.33	2.58	42.30
		20	-	-	-	-	14.35	7.19	3.10	58.15	14.27	8.59	3.10	57.90	14.16	9.96	3.07	57.12	14.03	11.32	3.04	56.21
	5	15	5.01	5.01	0.86	6.40	6.44	6.44	1.11	9.79	7.84	7.84	1.35	13.71	9.21	9.21	1.59	18.11	10.58	10.58	1.82	22.98
		17	5.83	5.01	1.00	8.26	6.57	6.46	1.13	10.15	7.87	7.87	1.36	13.90	9.23	9.23	1.59	18.17	10.60	10.60	1.83	23.06
		19	-	-	-	-	10.15	6.45	1.75	21.40	10.05	7.85	1.73	21.04	10.14	9.24	1.75	21.34	10.78	10.63	1.86	23.75
		20	-	-	-	-	12.51	6.47	2.15	30.70	12.40	7.86	2.14	30.25	12.28	9.24	2.12	29.73	12.22	10.61	2.10	29.47
6	15	4.27	4.27	0.61	3.29	5.71	5.71	0.82	5.82	7.12	7.12	1.02	8.48	8.51	8.51	1.22	11.50	9.88	9.88	1.42	14.86	
	17	4.44	4.29	0.64	3.61	5.72	5.71	0.82	5.84	7.14	7.14	1.02	8.51	8.53	8.53	1.22	11.54	9.90	9.90	1.42	14.90	
	19	-	-	-	-	8.18	5.72	1.17	10.73	8.25	7.14	1.18	10.88	8.87	8.55	1.27	12.34	9.92	9.92	1.42	14.96	
	20	-	-	-	-	10.57	5.75	1.52	16.65	10.45	7.14	1.50	16.34	10.40	8.53	1.49	16.20	10.69	9.93	1.53	17.00	

Continued:

MDVF-1400D303E																							
EWT	ΔT	Indoor temp (W.B.)	Indoor temperature (D.B.)																				
			21				23				25				27				29				
			TC	SC	WF	WPD	TC	SC	WF	WPD	TC	SC	WF	WPD	TC	SC	WF	WPD	TC	SC	WF	WPD	
°C	°C	°C	kW	kW	m³/h	kPa	kW	kW	m³/h	kPa	kW	kW	m³/h	kPa	kW	kW	m³/h	kPa	kW	kW	m³/h	kPa	
11	3	15	5.05	5.05	1.45	15.35	6.45	6.45	1.84	23.30	7.84	7.84	2.24	32.67	9.21	9.21	2.63	43.28	10.57	10.57	3.02	55.11	
		17	5.88	5.04	1.68	19.80	6.51	6.48	1.86	23.63	7.85	7.85	2.24	32.77	9.23	9.23	2.64	43.41	10.60	10.60	3.03	55.28	
		19	-	-	-	-	10.24	6.48	2.95	52.71	10.13	7.87	2.92	51.71	10.08	9.26	2.89	50.85	10.65	10.63	3.05	55.84	
		20	-	-	-	-	12.53	6.48	3.59	74.31	12.43	7.87	3.56	73.27	12.35	9.26	3.56	73.22	12.25	10.63	3.53	72.29	
	4	15	4.32	4.32	0.93	7.13	5.74	5.74	1.23	11.59	7.14	7.14	1.53	16.84	8.52	8.52	1.83	22.85	9.89	9.89	2.12	29.66	
		17	4.47	4.35	0.96	7.55	5.75	5.75	1.23	11.62	7.15	7.15	1.53	16.89	8.53	8.53	1.83	22.92	9.91	9.91	2.13	29.76	
		19	-	-	-	-	8.25	5.75	1.77	21.61	8.24	7.15	1.77	21.56	8.76	8.56	1.88	23.99	9.93	9.92	2.13	29.86	
		20	-	-	-	-	10.65	5.77	2.29	33.78	10.54	7.17	2.27	33.16	10.45	8.55	2.25	32.67	10.59	9.94	2.28	33.45	
	5	15	3.58	3.58	0.62	3.40	5.03	5.03	0.87	6.34	6.44	6.44	1.11	9.66	7.82	7.82	1.34	13.37	9.21	9.21	1.59	17.84	
		17	3.59	3.57	0.62	3.41	5.04	5.04	0.87	6.36	6.46	6.46	1.11	9.70	7.83	7.83	1.34	13.41	9.22	9.22	1.59	17.89	
		19	-	-	-	-	6.31	5.03	1.09	9.31	6.83	6.48	1.18	10.68	7.86	7.85	1.35	13.47	9.24	9.24	1.59	17.96	
		20	-	-	-	-	8.64	5.05	1.49	15.96	8.56	6.45	1.47	15.71	8.72	7.87	1.50	16.23	9.43	9.26	1.63	18.60	
	6	15	2.93	2.93	0.42	1.25	4.28	4.28	0.61	3.39	5.71	5.71	0.82	5.70	7.12	7.12	1.02	8.29	8.50	8.50	1.22	11.24	
		17	2.93	2.93	0.42	1.26	4.29	4.29	0.62	3.40	5.72	5.72	0.82	5.72	7.13	7.13	1.02	8.32	8.52	8.52	1.22	11.27	
		19	-	-	-	-	4.64	4.31	0.67	4.01	5.76	5.74	0.82	5.78	7.14	7.14	1.02	8.35	8.53	8.53	1.22	11.31	
		20	-	-	-	-	6.45	4.29	0.92	7.00	6.63	5.73	0.95	7.34	7.42	7.16	1.06	8.91	8.55	8.54	1.22	11.34	
	13	3	15	3.62	3.62	1.04	8.62	5.05	5.05	1.45	15.21	6.44	6.44	1.85	23.21	7.82	7.82	2.23	32.09	9.19	9.19	2.64	42.84
			17	3.63	3.62	1.04	8.65	5.06	5.06	1.45	15.26	6.46	6.46	1.86	23.29	7.83	7.83	2.24	32.19	9.21	9.21	2.64	42.98
			19	-	-	-	-	6.34	5.05	1.82	22.53	6.69	6.49	1.92	24.77	7.85	7.84	2.24	32.29	9.23	9.23	2.65	43.13
			20	-	-	-	-	8.65	5.05	2.47	38.32	8.55	6.45	2.44	37.52	8.58	7.85	2.45	37.77	9.28	9.26	2.66	43.56
		4	15	2.88	2.88	0.62	3.47	4.32	4.32	0.92	7.01	5.73	5.73	1.23	11.38	7.14	7.14	1.54	16.75	8.51	8.51	1.83	22.69
			17	2.88	2.88	0.62	3.49	4.32	4.32	0.93	7.03	5.74	5.74	1.23	11.42	7.15	7.15	1.54	16.80	8.52	8.52	1.84	22.76
			19	-	-	-	-	4.63	4.35	0.99	7.90	5.76	5.74	1.23	11.46	7.16	7.16	1.54	16.86	8.54	8.54	1.84	22.84
			20	-	-	-	-	6.60	4.34	1.42	14.62	6.65	5.76	1.43	14.83	7.34	7.19	1.58	17.59	8.55	8.54	1.84	22.88
5		15	2.21	2.21	0.38	0.99	3.58	3.58	0.61	3.41	5.02	5.02	0.86	6.18	6.43	6.43	1.10	9.42	7.81	7.81	1.34	13.16	
		17	2.22	2.22	0.38	1.00	3.59	3.59	0.62	3.43	5.03	5.03	0.86	6.20	6.44	6.44	1.11	9.45	7.83	7.83	1.34	13.20	
		19	-	-	-	-	3.59	3.58	0.62	3.44	5.04	5.04	0.86	6.22	6.45	6.45	1.11	9.48	7.84	7.84	1.35	13.25	
		20	-	-	-	-	4.43	3.59	0.76	4.99	5.26	5.06	0.90	6.69	6.46	6.44	1.11	9.50	7.85	7.85	1.35	13.27	
6		15	1.52	1.52	0.22	0.50	2.92	2.92	0.42	1.27	4.29	4.29	0.61	3.40	5.72	5.72	0.82	5.63	7.12	7.12	1.02	8.18	
		17	1.53	1.53	0.22	0.50	2.92	2.92	0.42	1.28	4.29	4.29	0.61	3.42	5.73	5.73	0.82	5.65	7.13	7.13	1.02	8.20	
		19	-	-	-	-	2.93	2.93	0.42	1.29	4.30	4.30	0.62	3.43	5.74	5.74	0.82	5.67	7.14	7.14	1.02	8.23	
		20	-	-	-	-	3.10	2.93	0.44	1.51	4.31	4.29	0.62	3.44	5.75	5.75	0.82	5.68	7.15	7.15	1.02	8.25	
15		3	15	-	-	-	3.61	3.61	1.03	8.36	5.04	5.04	1.45	14.98	6.41	6.41	1.83	22.44	7.79	7.79	2.23	31.50	
			17	2.17	2.17	0.62	3.47	3.62	3.62	1.03	8.38	5.05	5.05	1.45	15.03	6.43	6.43	1.84	22.51	7.81	7.81	2.23	31.60
			19	-	-	-	-	3.62	3.60	1.03	8.40	5.06	5.06	1.45	15.08	6.44	6.44	1.84	22.59	7.82	7.82	2.24	31.71
			20	-	-	-	-	4.49	3.61	1.28	12.09	5.17	5.09	1.49	15.63	6.44	6.44	1.84	22.63	7.83	7.83	2.24	31.77
		4	15	1.50	1.50	0.32	0.74	2.88	2.88	0.62	3.45	4.32	4.32	0.93	6.92	5.74	5.74	1.24	11.36	7.11	7.11	1.53	16.35
			17	1.50	1.50	0.32	0.74	2.88	2.88	0.62	3.47	4.33	4.33	0.93	6.95	5.75	5.75	1.24	11.40	7.12	7.12	1.53	16.34
			19	-	-	-	-	2.89	2.89	0.62	3.48	4.34	4.34	0.93	6.97	5.76	5.76	1.24	11.44	7.13	7.13	1.53	16.37
			20	-	-	-	-	2.97	2.93	0.64	3.66	4.34	4.33	0.93	6.98	5.77	5.77	1.24	11.46	7.14	7.14	1.53	16.40
	5	15	0.44	0.44	0.04	0.08	2.22	2.22	0.38	1.03	3.60	3.60	0.62	3.47	5.03	5.03	0.87	6.16	6.43	6.43	1.11	9.36	
		17	0.79	0.79	0.14	0.30	2.22	2.22	0.38	1.03	3.60	3.60	0.62	3.49	5.04	5.04	0.87	6.18	6.44	6.44	1.11	9.39	
		19	-	-	-	-	2.23	2.23	0.38	1.04	3.61	3.61	0.62	3.50	5.05	5.05	0.87	6.20	6.45	6.45	1.11	9.42	
		20	-	-	-	-	2.23	2.21	0.38	1.04	3.62	3.62	0.62	3.51	5.05	5.05	0.87	6.21	6.46	6.46	1.11	9.44	
	6	15	-	-	-	-	1.53	1.53	0.22	0.48	2.91	2.91	0.42	1.33	4.30	4.30	0.62	3.43	5.72	5.72	0.82	5.59	
		17	-	-	-	-	1.53	1.53	0.22	0.48	2.92	2.92	0.42	1.34	4.31	4.31	0.62	3.45	5.73	5.73	0.82	5.61	
		19	-	-	-	-	1.53	1.53	0.22	0.48	2.92	2.92	0.42	1.34	4.32	4.32	0.62	3.46	5.75	5.75	0.83	5.63	
		20	-	-	-	-	1.53	1.53	0.22	0.48	2.93	2.93	0.42	1.35	4.32	4.32	0.62	3.47	5.75	5.75	0.83	5.64	

Cooling capacity modification coefficient table:

Speed	200		300		400		500		600		800		1000		1200		1400	
	TC	SC	TC	SC	TC	SC	TC	SC	TC	SC	TC	SC	TC	SC	TC	SC	TC	SC
High	1	1	1	1	1	1	1	1	1	1	1	1	1	1	1	1	1	1
Med	0.86	0.82	0.87	0.83	0.85	0.81	0.86	0.83	0.84	0.8	0.84	0.82	0.87	0.84	0.89	0.85	0.86	0.81
Low	0.76	0.72	0.74	0.7	0.74	0.71	0.75	0.71	0.77	0.73	0.76	0.73	0.73	0.7	0.76	0.71	0.76	0.72

3-row Duct 30Pa Heating Capacity

EWT: Enter Water Temp. (°C) **Δt:** Temperature Difference (°C) **DB:** Dry Bulb Temp. (°C) **WB:** Wet Bulb Temp. (°C)
TC: Total Cooling Capacity (kW) **SC:** Sensible Cooling Capacity (kW) **WF:** Water Flow (m³/h) **WPD:** Water Pressure Drop (kPa)

MDVF-200D303E													
EWT	ΔT	Indoor temperature (W.B.)											
		16			18			20			22		
		TH	WF	WPD	TH	WF	WPD	TH	WF	WPD	TH	WF	WPD
°C	°C	kW	m³/h	kPa	kW	m³/h	kPa	kW	m³/h	kPa	kW	m³/h	kPa
40	8	2.12	0.23	3.28	1.85	0.20	2.59	1.57	0.17	1.97	1.30	0.14	1.41
	10	1.84	0.16	1.78	1.56	0.13	1.29	1.30	0.11	0.81	1.05	0.09	0.45
	12	1.57	0.11	0.80	1.31	0.09	0.50	1.05	0.08	0.34	0.79	0.06	0.25
	14	1.32	0.08	0.38	1.05	0.06	0.30	0.79	0.05	0.22	0.53	0.03	0.15
	16	1.06	0.06	0.27	0.80	0.04	0.20	0.53	0.03	0.14	0.27	0.01	0.07
45	8	2.81	0.30	5.15	2.53	0.27	4.31	2.26	0.24	3.54	1.98	0.21	2.84
	10	2.54	0.22	2.97	2.26	0.19	2.44	1.98	0.17	1.96	1.71	0.15	1.52
	12	2.26	0.16	1.81	1.98	0.14	1.44	1.70	0.12	1.05	1.44	0.10	0.68
	14	1.97	0.12	1.02	1.70	0.11	0.70	1.45	0.09	0.45	1.19	0.07	0.31
	16	1.72	0.09	0.49	1.46	0.08	0.35	1.20	0.06	0.28	0.93	0.05	0.22
50	8	3.49	0.38	7.31	3.21	0.35	6.33	2.93	0.32	5.41	2.66	0.29	4.57
	10	3.22	0.28	4.38	2.94	0.25	3.75	2.67	0.23	3.17	2.39	0.21	2.63
	12	2.95	0.21	2.77	2.67	0.19	2.34	2.39	0.17	1.94	2.12	0.15	1.58
	14	2.67	0.16	1.81	2.39	0.15	1.50	2.11	0.13	1.21	1.84	0.11	0.90
	16	2.39	0.13	1.19	2.11	0.11	0.90	1.85	0.10	0.63	1.59	0.09	0.42
55	8	4.17	0.45	9.75	3.88	0.42	8.63	3.61	0.39	7.58	3.33	0.36	6.60
	10	3.90	0.34	5.97	3.62	0.31	5.25	3.35	0.29	4.57	3.07	0.27	3.94
	12	3.64	0.26	3.87	3.36	0.24	3.37	3.08	0.22	2.91	2.80	0.20	2.47
	14	3.37	0.21	2.63	3.09	0.19	2.27	2.81	0.17	1.93	2.53	0.16	1.62
	16	3.09	0.17	1.82	2.81	0.15	1.55	2.53	0.14	1.29	2.25	0.12	1.05
60	8	4.85	0.52	12.47	4.56	0.49	11.21	4.28	0.46	10.07	4.00	0.43	8.96
	10	4.59	0.40	7.71	4.30	0.37	6.90	4.02	0.35	6.13	3.74	0.32	5.41
	12	4.33	0.31	5.12	4.04	0.29	4.55	3.76	0.27	4.02	3.48	0.25	3.51
	14	4.06	0.25	3.53	3.78	0.23	3.11	3.50	0.22	2.73	3.22	0.20	2.37
	16	3.79	0.20	2.51	3.51	0.19	2.20	3.23	0.17	1.91	2.95	0.16	1.63

Heating Capacity

MDVF-300D303E													
EWT	ΔT	Indoor temperature (W.B.)											
		16			18			20			22		
		TH	WF	WPD	TH	WF	WPD	TH	WF	WPD	TH	WF	WPD
°C	°C	kW	m³/h	kPa	kW	m³/h	kPa	kW	m³/h	kPa	kW	m³/h	kPa
40	8	2.76	0.30	6.12	2.41	0.26	4.84	2.06	0.22	3.71	1.71	0.18	2.71
	10	2.42	0.21	3.37	2.07	0.18	2.58	1.72	0.15	1.86	1.37	0.12	1.10
	12	2.07	0.15	1.89	1.72	0.12	1.22	1.39	0.10	0.68	1.05	0.08	0.40
	14	1.74	0.11	0.80	1.40	0.09	0.49	1.05	0.06	0.36	0.71	0.04	0.24
	16	1.41	0.08	0.43	1.06	0.06	0.33	0.72	0.04	0.22	0.36	0.02	0.11
45	8	3.63	0.39	9.54	3.27	0.35	7.99	2.92	0.32	6.57	2.57	0.28	5.28
	10	3.30	0.28	5.54	2.94	0.25	4.56	2.59	0.22	3.66	2.24	0.19	2.86
	12	2.96	0.21	3.41	2.60	0.19	2.74	2.25	0.16	2.14	1.89	0.14	1.58
	14	2.61	0.16	2.13	2.25	0.14	1.63	1.90	0.12	1.09	1.56	0.10	0.64
	16	2.26	0.12	1.19	1.92	0.10	0.77	1.58	0.09	0.48	1.23	0.07	0.34
50	8	4.49	0.48	13.52	4.14	0.45	11.70	3.78	0.41	10.01	3.43	0.37	8.45
	10	4.17	0.36	8.13	3.81	0.33	6.96	3.45	0.30	5.88	3.10	0.27	4.89
	12	3.83	0.28	5.15	3.47	0.25	4.36	3.12	0.22	3.62	2.77	0.20	2.95
	14	3.49	0.22	3.40	3.13	0.19	2.83	2.78	0.17	2.31	2.42	0.15	1.83
	16	3.15	0.17	2.30	2.79	0.15	1.87	2.43	0.13	1.46	2.08	0.11	1.02
55	8	5.36	0.58	18.10	5.00	0.54	16.01	4.64	0.50	14.07	4.28	0.46	12.17
	10	5.03	0.44	11.04	4.67	0.40	9.70	4.31	0.37	8.45	3.96	0.34	7.28
	12	4.70	0.34	7.17	4.34	0.31	6.24	3.98	0.29	5.38	3.63	0.26	4.59
	14	4.37	0.27	4.89	4.01	0.25	4.22	3.65	0.23	3.59	3.30	0.20	3.02
	16	4.03	0.22	3.40	3.67	0.20	2.90	3.31	0.18	2.43	2.95	0.16	2.00
60	8	6.23	0.67	23.00	5.86	0.63	20.67	5.49	0.59	18.47	5.14	0.56	16.50
	10	5.90	0.51	14.29	5.53	0.48	12.72	5.17	0.45	11.31	4.81	0.42	9.98
	12	5.57	0.40	9.46	5.21	0.37	8.41	4.85	0.35	7.42	4.49	0.32	6.50
	14	5.24	0.32	6.53	4.88	0.30	5.76	4.52	0.28	5.05	4.16	0.26	4.38
	16	4.91	0.26	4.67	4.55	0.25	4.09	4.19	0.23	3.55	3.83	0.21	3.04

Heating Capacity

MDVF-400D303E													
EWT	ΔT	Indoor temperature (W.B.)											
		16			18			20			22		
		TH	WF	WPD	TH	WF	WPD	TH	WF	WPD	TH	WF	WPD
°C	°C	kW	m³/h	kPa	kW	m³/h	kPa	kW	m³/h	kPa	kW	m³/h	kPa
40	8	3.73	0.40	3.94	3.25	0.35	3.12	2.77	0.30	2.38	2.30	0.25	1.73
	10	3.25	0.28	2.16	2.77	0.24	1.64	2.29	0.20	1.12	1.84	0.16	0.63
	12	2.77	0.20	1.12	2.31	0.17	0.70	1.86	0.13	0.40	1.40	0.10	0.28
	14	2.33	0.14	0.46	1.87	0.12	0.33	1.40	0.09	0.24	0.94	0.06	0.17
	16	1.88	0.10	0.30	1.41	0.08	0.22	0.95	0.05	0.15	0.48	0.03	0.08
45	8	4.91	0.53	6.17	4.43	0.48	5.16	3.95	0.43	4.24	3.47	0.37	3.40
	10	4.45	0.38	3.57	3.96	0.34	2.93	3.48	0.30	2.36	3.01	0.26	1.83
	12	3.98	0.29	2.19	3.49	0.25	1.75	3.01	0.22	1.36	2.53	0.18	0.95
	14	3.49	0.21	1.34	3.00	0.19	0.97	2.54	0.16	0.63	2.10	0.13	0.38
	16	3.02	0.16	0.68	2.57	0.14	0.44	2.11	0.11	0.31	1.65	0.09	0.23
50	8	6.09	0.66	8.75	5.60	0.60	7.57	5.12	0.55	6.48	4.64	0.50	5.47
	10	5.64	0.49	5.25	5.15	0.45	4.49	4.67	0.40	3.80	4.19	0.36	3.15
	12	5.17	0.37	3.32	4.68	0.34	2.81	4.21	0.30	2.33	3.72	0.27	1.90
	14	4.70	0.29	2.19	4.21	0.26	1.81	3.73	0.23	1.48	3.24	0.20	1.16
	16	4.22	0.23	1.47	3.73	0.20	1.18	3.25	0.18	0.87	2.78	0.15	0.59
55	8	7.27	0.78	11.67	6.78	0.73	10.33	6.29	0.68	9.07	5.80	0.63	7.89
	10	6.82	0.59	7.15	6.32	0.55	6.28	5.84	0.50	5.47	5.36	0.46	4.71
	12	6.36	0.46	4.63	5.87	0.42	4.03	5.38	0.39	3.48	4.90	0.35	2.96
	14	5.90	0.36	3.15	5.41	0.33	2.72	4.93	0.30	2.31	4.44	0.27	1.94
	16	5.43	0.29	2.19	4.94	0.27	1.86	4.45	0.24	1.56	3.97	0.21	1.28
60	8	8.45	0.91	15.00	7.95	0.86	13.41	7.46	0.80	11.99	6.97	0.75	10.65
	10	8.00	0.69	9.22	7.50	0.65	8.25	7.01	0.60	7.33	6.52	0.56	6.47
	12	7.55	0.54	6.12	7.05	0.51	5.44	6.56	0.47	4.80	6.08	0.44	4.20
	14	7.09	0.44	4.22	6.60	0.41	3.72	6.11	0.38	3.26	5.62	0.35	2.83
	16	6.63	0.36	3.00	6.13	0.33	2.63	5.64	0.30	2.28	5.16	0.28	1.96

Heating Capacity

MDVF-500D303E													
EWT	ΔT	Indoor temperature (W.B.)											
		16			18			20			22		
		TH	WF	WPD	TH	WF	WPD	TH	WF	WPD	TH	WF	WPD
°C	°C	kW	m³/h	kPa	kW	m³/h	kPa	kW	m³/h	kPa	kW	m³/h	kPa
40	8	4.97	0.54	6.46	4.34	0.47	5.11	3.71	0.40	3.91	3.08	0.33	2.85
	10	4.36	0.38	3.55	3.73	0.32	2.72	3.10	0.27	1.98	2.46	0.21	1.32
	12	3.74	0.27	2.03	3.10	0.22	1.45	2.48	0.18	0.84	1.88	0.14	0.41
	14	3.11	0.19	0.99	2.50	0.15	0.55	1.89	0.12	0.33	1.27	0.08	0.22
	16	2.53	0.14	0.42	1.91	0.10	0.30	1.28	0.07	0.21	0.65	0.04	0.11
45	8	6.52	0.70	10.09	5.88	0.63	8.44	5.25	0.57	6.93	4.62	0.50	5.56
	10	5.92	0.51	5.85	5.29	0.46	4.81	4.65	0.40	3.86	4.02	0.35	3.01
	12	5.32	0.38	3.59	4.68	0.34	2.89	4.05	0.29	2.25	3.41	0.25	1.69
	14	4.70	0.29	2.25	4.06	0.25	1.75	3.42	0.21	1.29	2.79	0.17	0.80
	16	4.06	0.22	1.40	3.43	0.19	0.95	2.82	0.15	0.56	2.21	0.12	0.33
50	8	8.07	0.87	14.31	7.43	0.80	12.38	6.79	0.73	10.58	6.16	0.66	8.93
	10	7.48	0.65	8.59	6.84	0.59	7.35	6.20	0.54	6.20	5.57	0.48	5.15
	12	6.88	0.49	5.44	6.24	0.45	4.59	5.60	0.40	3.82	4.97	0.36	3.11
	14	6.28	0.39	3.59	5.63	0.35	2.98	5.00	0.31	2.43	4.36	0.27	1.93
	16	5.67	0.31	2.42	5.02	0.27	1.97	4.38	0.24	1.56	3.74	0.20	1.19
55	8	9.62	1.04	19.18	8.97	0.97	16.96	8.33	0.90	14.88	7.68	0.83	12.88
	10	9.04	0.78	11.68	8.39	0.72	10.26	7.75	0.67	8.93	7.11	0.61	7.69
	12	8.44	0.61	7.57	7.79	0.56	6.59	7.15	0.51	5.68	6.51	0.47	4.83
	14	7.85	0.48	5.16	7.20	0.44	4.44	6.56	0.40	3.78	5.92	0.37	3.18
	16	7.24	0.39	3.58	6.59	0.36	3.05	5.95	0.32	2.56	5.31	0.29	2.11
60	8	11.18	1.20	24.40	10.52	1.13	21.92	9.87	1.06	19.58	9.23	1.00	17.48
	10	10.59	0.92	15.13	9.93	0.86	13.47	9.28	0.80	11.96	8.64	0.74	10.55
	12	10.00	0.72	10.00	9.35	0.67	8.88	8.70	0.63	7.84	8.06	0.58	6.86
	14	9.41	0.58	6.89	8.75	0.54	6.08	8.11	0.50	5.32	7.46	0.46	4.62
	16	8.81	0.48	4.92	8.16	0.44	4.31	7.51	0.41	3.74	6.87	0.37	3.21

Heating Capacity

MDVF-600D303E													
EWT	ΔT	Indoor temperature (W.B.)											
		16			18			20			22		
		TH	WF	WPD	TH	WF	WPD	TH	WF	WPD	TH	WF	WPD
$^{\circ}\text{C}$	$^{\circ}\text{C}$	kW	m^3/h	kPa	kW	m^3/h	kPa	kW	m^3/h	kPa	kW	m^3/h	kPa
40	8	5.72	0.62	10.73	5.00	0.54	8.51	4.28	0.46	6.48	3.57	0.38	4.74
	10	5.03	0.43	5.89	4.31	0.37	4.52	3.59	0.31	3.31	2.87	0.25	2.27
	12	4.34	0.31	3.39	3.61	0.26	2.48	2.88	0.21	1.60	2.19	0.16	0.77
	14	3.61	0.22	1.85	2.90	0.18	1.07	2.21	0.14	0.54	1.49	0.09	0.34
	16	2.94	0.16	0.76	2.23	0.12	0.46	1.50	0.08	0.31	0.77	0.04	0.16
45	8	7.49	0.81	16.64	6.76	0.73	13.97	6.04	0.65	11.45	5.32	0.57	9.21
	10	6.82	0.59	9.67	6.09	0.53	7.96	5.37	0.46	6.41	4.65	0.40	5.01
	12	6.14	0.44	5.96	5.41	0.39	4.80	4.69	0.34	3.75	3.96	0.29	2.82
	14	5.44	0.34	3.74	4.71	0.29	2.93	3.98	0.25	2.20	3.25	0.20	1.50
	16	4.73	0.26	2.38	3.99	0.22	1.75	3.27	0.18	1.09	2.57	0.14	0.57
50	8	9.26	1.00	23.70	8.52	0.92	20.41	7.79	0.84	17.46	7.07	0.76	14.74
	10	8.60	0.74	14.18	7.86	0.68	12.14	7.14	0.62	10.26	6.41	0.55	8.53
	12	7.92	0.57	8.99	7.19	0.52	7.60	6.46	0.46	6.33	5.74	0.41	5.16
	14	7.24	0.45	5.95	6.51	0.40	4.95	5.78	0.36	4.04	5.05	0.31	3.21
	16	6.56	0.35	4.03	5.82	0.31	3.29	5.09	0.27	2.62	4.35	0.24	2.01
55	8	11.03	1.19	31.45	10.29	1.11	27.83	9.55	1.03	24.41	8.82	0.95	21.36
	10	10.37	0.89	19.19	9.63	0.83	16.86	8.89	0.77	14.68	8.17	0.71	12.71
	12	9.70	0.70	12.50	8.96	0.64	10.89	8.23	0.59	9.40	7.50	0.54	8.01
	14	9.04	0.56	8.54	8.30	0.51	7.37	7.57	0.47	6.28	6.84	0.42	5.28
	16	8.35	0.45	5.96	7.61	0.41	5.06	6.88	0.37	4.25	6.15	0.33	3.51
60	8	12.80	1.38	40.28	12.05	1.30	36.20	11.32	1.22	32.47	10.58	1.14	28.78
	10	12.15	1.05	24.96	11.40	0.98	22.32	10.66	0.92	19.84	9.92	0.86	17.50
	12	11.49	0.83	16.51	10.74	0.77	14.68	10.00	0.72	12.96	9.27	0.67	11.35
	14	10.82	0.67	11.39	10.07	0.62	10.06	9.33	0.57	8.82	8.60	0.53	7.65
	16	10.15	0.55	8.15	9.40	0.51	7.15	8.66	0.47	6.20	7.93	0.43	5.33

Heating Capacity

MDVF-800D303E													
EWT	ΔT	Indoor temperature (W.B.)											
		16			18			20			22		
		TH	WF	WPD	TH	WF	WPD	TH	WF	WPD	TH	WF	WPD
°C	°C	kW	m³/h	kPa	kW	m³/h	kPa	kW	m³/h	kPa	kW	m³/h	kPa
40	8	6.88	0.74	8.89	6.01	0.65	7.00	5.14	0.55	5.37	4.28	0.46	3.93
	10	6.05	0.52	4.88	5.18	0.45	3.74	4.31	0.37	2.74	3.43	0.30	1.85
	12	5.20	0.37	2.80	4.32	0.31	2.03	3.45	0.25	1.22	2.63	0.19	0.59
	14	4.32	0.27	1.42	3.49	0.21	0.80	2.65	0.16	0.45	1.79	0.11	0.30
	16	3.54	0.19	0.59	2.68	0.14	0.41	1.81	0.10	0.28	0.92	0.05	0.14
45	8	9.02	0.97	13.79	8.14	0.88	11.55	7.27	0.78	9.50	6.41	0.69	7.64
	10	8.21	0.71	8.01	7.33	0.63	6.60	6.46	0.56	5.31	5.59	0.48	4.15
	12	7.38	0.53	4.94	6.50	0.47	3.97	5.63	0.41	3.11	4.75	0.34	2.34
	14	6.53	0.40	3.10	5.65	0.35	2.42	4.76	0.29	1.81	3.89	0.24	1.16
	16	5.66	0.31	1.95	4.78	0.26	1.36	3.93	0.21	0.82	3.10	0.17	0.46
50	8	11.15	1.20	19.55	10.27	1.11	16.92	9.39	1.01	14.48	8.52	0.92	12.23
	10	10.35	0.90	11.75	9.47	0.82	10.07	8.59	0.74	8.51	7.72	0.67	7.08
	12	9.54	0.69	7.45	8.65	0.62	6.30	7.78	0.56	5.25	6.90	0.50	4.28
	14	8.71	0.54	4.93	7.83	0.48	4.10	6.95	0.43	3.35	6.07	0.37	2.66
	16	7.88	0.43	3.34	6.99	0.38	2.72	6.10	0.33	2.16	5.22	0.28	1.66
55	8	13.29	1.43	26.06	12.39	1.34	23.05	11.52	1.24	20.36	10.64	1.15	17.72
	10	12.50	1.08	15.91	11.60	1.00	13.98	10.73	0.93	12.23	9.85	0.85	10.55
	12	11.69	0.84	10.37	10.80	0.78	9.04	9.91	0.71	7.80	9.04	0.65	6.64
	14	10.88	0.67	7.08	9.99	0.62	6.11	9.11	0.56	5.21	8.23	0.51	4.38
	16	10.05	0.54	4.92	9.15	0.49	4.20	8.27	0.45	3.53	7.39	0.40	2.91
60	8	15.44	1.67	33.47	14.54	1.57	30.03	13.65	1.47	26.78	12.75	1.37	23.80
	10	14.65	1.26	20.69	13.74	1.19	18.50	12.85	1.11	16.45	11.97	1.03	14.52
	12	13.84	1.00	13.69	12.94	0.93	12.18	12.05	0.87	10.75	11.17	0.80	9.42
	14	13.03	0.80	9.45	12.14	0.75	8.35	11.25	0.69	7.32	10.36	0.64	6.35
	16	12.22	0.66	6.76	11.33	0.61	5.93	10.43	0.56	5.15	9.55	0.52	4.42

Heating Capacity

MDVF-1000D303E													
EWT	ΔT	Indoor temperature (W.B.)											
		16			18			20			22		
		TH	WF	WPD	TH	WF	WPD	TH	WF	WPD	TH	WF	WPD
$^{\circ}\text{C}$	$^{\circ}\text{C}$	kW	m ³ /h	kPa	kW	m ³ /h	kPa	kW	m ³ /h	kPa	kW	m ³ /h	kPa
40	8	7.89	0.85	6.62	6.89	0.74	5.25	5.90	0.64	4.02	4.90	0.53	2.93
	10	6.92	0.60	3.63	5.90	0.51	2.78	4.89	0.42	2.02	3.88	0.33	1.30
	12	5.89	0.42	2.06	4.87	0.35	1.43	3.91	0.28	0.82	3.00	0.22	0.42
	14	4.88	0.30	0.95	3.96	0.24	0.55	3.01	0.19	0.35	2.03	0.13	0.24
	16	4.01	0.22	0.43	3.03	0.16	0.32	2.05	0.11	0.22	1.05	0.06	0.11
45	8	10.38	1.12	10.38	9.37	1.01	8.70	8.38	0.90	7.16	7.38	0.80	5.76
	10	9.43	0.81	6.02	8.42	0.73	4.95	7.41	0.64	3.99	6.42	0.55	3.11
	12	8.46	0.61	3.69	7.45	0.54	2.97	6.43	0.46	2.32	5.41	0.39	1.73
	14	7.44	0.46	2.30	6.42	0.40	1.79	5.39	0.33	1.29	4.42	0.27	0.79
	16	6.40	0.35	1.39	5.41	0.29	0.93	4.48	0.24	0.56	3.54	0.19	0.34
50	8	12.87	1.39	14.75	11.85	1.28	12.78	10.84	1.17	10.95	9.84	1.06	9.25
	10	11.93	1.03	8.86	10.92	0.94	7.60	9.91	0.86	6.43	8.91	0.77	5.35
	12	10.96	0.79	5.61	9.96	0.72	4.75	8.95	0.64	3.95	7.95	0.57	3.22
	14	10.01	0.62	3.70	8.99	0.55	3.08	7.97	0.49	2.51	6.96	0.43	1.99
	16	9.02	0.49	2.49	7.99	0.43	2.03	6.96	0.38	1.61	5.93	0.32	1.20
55	8	15.35	1.66	19.80	14.32	1.55	17.54	13.32	1.44	15.42	12.30	1.33	13.36
	10	14.43	1.25	12.08	13.41	1.16	10.62	12.39	1.07	9.26	11.38	0.98	7.99
	12	13.48	0.97	7.83	12.46	0.90	6.83	11.45	0.82	5.90	10.44	0.75	5.03
	14	12.54	0.77	5.34	11.52	0.71	4.61	10.50	0.65	3.93	9.49	0.59	3.31
	16	11.56	0.62	3.70	10.54	0.57	3.16	9.52	0.51	2.66	8.50	0.46	2.19
60	8	17.84	1.92	25.21	16.81	1.81	22.69	15.78	1.70	20.31	14.76	1.59	18.06
	10	16.92	1.46	15.65	15.89	1.37	14.02	14.86	1.28	12.42	13.85	1.19	10.98
	12	15.99	1.15	10.36	14.96	1.08	9.22	13.94	1.00	8.15	12.93	0.93	7.15
	14	15.05	0.93	7.14	14.02	0.86	6.32	13.00	0.80	5.54	11.98	0.74	4.82
	16	14.11	0.76	5.11	13.08	0.71	4.48	12.06	0.65	3.90	11.04	0.60	3.35

Heating Capacity

MDVF-1200D303E													
EWT	ΔT	Indoor temperature (W.B.)											
		16			18			20			22		
		TH	WF	WPD	TH	WF	WPD	TH	WF	WPD	TH	WF	WPD
°C	°C	kW	m³/h	kPa	kW	m³/h	kPa	kW	m³/h	kPa	kW	m³/h	kPa
40	8	9.50	1.02	6.74	8.30	0.90	5.34	7.10	0.77	4.09	5.90	0.64	2.98
	10	8.32	0.72	3.69	7.11	0.61	2.82	5.89	0.51	2.05	4.67	0.40	1.32
	12	7.09	0.51	2.09	5.86	0.42	1.45	4.71	0.34	0.84	3.61	0.26	0.43
	14	5.87	0.36	0.97	4.77	0.29	0.56	3.63	0.22	0.36	2.45	0.15	0.24
	16	4.82	0.26	0.44	3.65	0.20	0.32	2.47	0.13	0.22	1.27	0.07	0.11
45	8	12.50	1.35	10.56	11.29	1.22	8.85	10.09	1.09	7.29	8.89	0.96	5.86
	10	11.36	0.98	6.12	10.14	0.88	5.04	8.93	0.77	4.06	7.73	0.67	3.17
	12	10.19	0.73	3.76	8.97	0.65	3.02	7.75	0.56	2.36	6.53	0.47	1.76
	14	8.97	0.55	2.34	7.73	0.48	1.82	6.49	0.40	1.31	5.32	0.33	0.80
	16	7.70	0.42	1.41	6.51	0.35	0.95	5.40	0.29	0.57	4.27	0.23	0.35
50	8	15.49	1.67	15.02	14.27	1.54	13.01	13.06	1.41	11.15	11.86	1.28	9.42
	10	14.37	1.24	9.02	13.15	1.14	7.73	11.94	1.03	6.54	10.73	0.93	5.44
	12	13.22	0.95	5.71	12.00	0.86	4.83	10.78	0.78	4.02	9.57	0.69	3.28
	14	12.05	0.74	3.76	10.83	0.67	3.13	9.60	0.59	2.55	8.38	0.52	2.03
	16	10.86	0.59	2.53	9.62	0.52	2.06	8.39	0.45	1.63	7.14	0.39	1.22
55	8	18.49	2.00	20.16	17.26	1.87	17.86	16.04	1.73	15.70	14.81	1.60	13.61
	10	17.38	1.50	12.29	16.15	1.40	10.81	14.93	1.29	9.43	13.71	1.19	8.14
	12	16.24	1.17	7.97	15.01	1.08	6.95	13.79	0.99	6.00	12.58	0.90	5.12
	14	15.11	0.93	5.43	13.88	0.86	4.69	12.65	0.78	4.01	11.44	0.71	3.37
	16	13.93	0.75	3.77	12.70	0.68	3.22	11.47	0.62	2.70	10.25	0.55	2.23
60	8	21.49	2.31	25.66	20.25	2.18	23.11	19.01	2.05	20.69	17.77	1.92	18.39
	10	20.38	1.76	15.94	19.12	1.65	14.28	17.90	1.54	12.65	16.68	1.44	11.18
	12	19.26	1.39	10.54	18.03	1.30	9.39	16.79	1.21	8.30	15.57	1.12	7.28
	14	18.13	1.12	7.27	16.89	1.04	6.43	15.66	0.96	5.64	14.44	0.89	4.91
	16	16.99	0.92	5.20	15.76	0.85	4.57	14.52	0.78	3.97	13.30	0.72	3.41

Heating Capacity

MDVF-1400D303E													
EWT	ΔT	Indoor temperature (W.B.)											
		16			18			20			22		
		TH	WF	WPD	TH	WF	WPD	TH	WF	WPD	TH	WF	WPD
°C	°C	kW	m³/h	kPa	kW	m³/h	kPa	kW	m³/h	kPa	kW	m³/h	kPa
40	8	12.79	1.38	12.47	11.18	1.21	9.88	9.57	1.03	7.53	7.99	0.86	5.52
	10	11.28	0.97	6.85	9.66	0.83	5.26	8.05	0.69	3.85	6.45	0.56	2.64
	12	9.73	0.70	3.94	8.10	0.58	2.89	6.47	0.47	1.96	4.88	0.35	1.00
	14	8.11	0.50	2.24	6.49	0.40	1.38	4.94	0.30	0.66	3.35	0.21	0.37
	16	6.57	0.35	0.98	5.01	0.27	0.52	3.38	0.18	0.34	1.73	0.09	0.17
45	8	16.73	1.80	19.34	15.11	1.63	16.19	13.50	1.46	13.32	11.91	1.28	10.71
	10	15.25	1.32	11.24	13.63	1.18	9.25	12.02	1.04	7.45	10.42	0.90	5.83
	12	13.74	0.99	6.93	12.12	0.87	5.58	10.50	0.76	4.37	8.89	0.64	3.29
	14	12.19	0.75	4.36	10.56	0.65	3.41	8.93	0.55	2.57	7.30	0.45	1.82
	16	10.62	0.57	2.78	8.97	0.48	2.09	7.33	0.40	1.39	5.76	0.31	0.74
50	8	20.69	2.24	27.57	19.06	2.06	23.86	17.42	1.88	20.31	15.81	1.70	17.15
	10	19.22	1.66	16.49	17.57	1.52	14.12	15.96	1.38	11.93	14.35	1.24	9.92
	12	17.71	1.27	10.45	16.08	1.16	8.84	14.46	1.04	7.36	12.85	0.92	6.00
	14	16.21	1.00	6.92	14.57	0.90	5.76	12.94	0.80	4.70	11.33	0.70	3.74
	16	14.67	0.79	4.67	13.05	0.70	3.83	11.41	0.62	3.05	9.78	0.53	2.34
55	8	24.65	2.66	36.71	22.98	2.48	32.39	21.34	2.30	28.44	19.70	2.12	24.73
	10	23.16	2.00	22.33	21.52	1.86	19.62	19.88	1.71	17.08	18.26	1.57	14.72
	12	21.69	1.56	14.60	20.03	1.44	12.67	18.40	1.32	10.93	16.78	1.21	9.31
	14	20.22	1.25	9.93	18.56	1.15	8.57	16.93	1.04	7.30	15.31	0.94	6.14
	16	18.69	1.01	6.93	17.05	0.92	5.91	15.40	0.83	4.95	13.77	0.74	4.09
60	8	28.60	3.09	47.04	26.92	2.90	42.05	25.26	2.72	37.69	23.63	2.55	33.58
	10	27.12	2.34	28.98	25.48	2.20	25.99	23.82	2.06	23.09	22.18	1.92	20.38
	12	25.66	1.84	19.15	24.01	1.73	17.09	22.35	1.61	15.09	20.72	1.49	13.21
	14	24.18	1.49	13.25	22.52	1.39	11.71	20.88	1.29	10.26	19.24	1.19	8.90
	16	22.70	1.22	9.48	21.04	1.14	8.31	19.39	1.05	7.22	17.76	0.96	6.20

Heating capacity modification coefficient table:

Speed	200	300	400	500	600
	TH	TH	TH	TH	TH
High	1	1	1	1	1
Medium	0.86	0.87	0.86	0.85	0.84
Low	0.74	0.75	0.75	0.75	0.73
Speed	800	1000	1200	1400	
	TH	TH	TH	TH	
High	1	1	1	1	
Medium	0.86	0.87	0.85	0.86	
Low	0.75	0.74	0.74	0.75	

Altitude modification coefficient table:

Altitude (m)	TC	SC	TH
500	0.98	0.95	0.95
1000	0.97	0.91	0.91
1500	0.95	0.86	0.86
2000	0.94	0.82	0.82
2500	0.93	0.78	0.78
3000	0.91	0.74	0.7

Operating limits:

Mode	Outdoor Temp.	Room Temp.	Enter water
Cooling	0~43℃	17~32℃	3~20℃
Heating	-15~24℃	0~30℃	30~80℃

4-row Duct Cooling capacity

EWT: Enter Water Temp. (°C) **Δt:** Temperature Difference (°C) **DB:** Dry Bulb Temp. (°C) **WB:** Wet Bulb Temp. (°C)

TC: Total Cooling Capacity (kW) **SC:** Sensible Cooling Capacity (kW) **WF:** Water Flow (m³/h) **WPD:** Water Pressure Drop (kPa)

MDVF-200D304E																							
EWT	ΔT	Indoor temp (W.B.)	Indoor temperature (D.B.)																				
			21				23				25				27				29				
			TC	SC	WF	WPD	TC	SC	WF	WPD	TC	SC	WF	WPD	TC	SC	WF	WPD	TC	SC	WF	WPD	
°C	°C	°C	kW	kW	m³/h	kPa	kW	kW	m³/h	kPa	kW	kW	m³/h	kPa	kW	kW	m³/h	kPa	kW	kW	m³/h	kPa	
5	3	15	2.05	1.67	0.58	4.02	2.02	1.93	0.58	3.94	2.19	2.19	0.63	4.51	2.45	2.45	0.70	5.52	2.71	2.71	0.78	6.52	
		17	2.85	1.68	0.82	7.11	2.82	1.95	0.81	7.02	2.80	2.20	0.81	6.93	2.78	2.46	0.80	6.83	2.76	2.71	0.79	6.74	
		19	-	-	-	-	3.66	1.95	1.05	10.93	3.63	2.21	1.04	10.80	3.61	2.47	1.04	10.67	3.58	2.72	1.03	10.54	
		20	-	-	-	-	4.10	1.96	1.18	13.30	4.07	2.22	1.17	13.14	4.05	2.47	1.16	12.98	4.02	2.73	1.15	12.82	
	4	15	1.69	1.51	0.36	1.26	1.77	1.76	0.38	1.43	2.02	2.02	0.43	2.05	2.28	2.28	0.49	2.81	2.53	2.53	0.55	3.53	
		17	2.44	1.50	0.53	3.29	2.42	1.77	0.52	3.23	2.40	2.02	0.52	3.17	2.38	2.28	0.51	3.11	2.54	2.54	0.55	3.55	
		19	-	-	-	-	3.28	1.78	0.71	5.51	3.26	2.04	0.70	5.44	3.23	2.30	0.70	5.37	3.21	2.55	0.69	5.31	
		20	-	-	-	-	3.73	1.79	0.80	6.85	3.70	2.05	0.80	6.76	3.68	2.31	0.79	6.68	3.65	2.56	0.79	6.60	
	5	15	1.39	1.38	0.24	0.62	1.63	1.63	0.28	0.73	1.88	1.88	0.32	0.95	2.13	2.13	0.37	1.30	2.37	2.37	0.41	1.75	
		17	2.09	1.35	0.36	1.24	2.07	1.62	0.36	1.21	2.05	1.88	0.35	1.18	2.13	2.12	0.36	1.30	2.38	2.38	0.41	1.76	
		19	-	-	-	-	2.86	1.60	0.49	2.84	2.84	1.86	0.49	2.79	2.82	2.12	0.48	2.74	2.79	2.37	0.48	2.69	
		20	-	-	-	-	3.32	1.61	0.57	3.81	3.29	1.87	0.57	3.76	3.27	2.13	0.56	3.71	3.24	2.38	0.56	3.66	
	6	15	1.24	1.24	0.18	0.45	1.49	1.49	0.21	0.54	1.74	1.74	0.25	0.63	1.99	1.99	0.28	0.74	2.24	2.24	0.32	0.93	
		17	1.77	1.22	0.25	0.64	1.75	1.48	0.25	0.63	1.75	1.75	0.25	0.64	2.00	2.00	0.29	0.75	2.24	2.24	0.32	0.94	
		19	-	-	-	-	2.51	1.45	0.36	1.25	2.49	1.72	0.36	1.23	2.47	1.98	0.35	1.21	2.45	2.23	0.35	1.18	
		20	-	-	-	-	2.90	1.44	0.42	1.87	2.88	1.70	0.41	1.84	2.86	1.96	0.41	1.80	2.84	2.22	0.41	1.77	
	7	3	15	1.44	1.41	0.41	1.86	1.67	1.67	0.48	2.69	1.93	1.93	0.55	3.61	2.19	2.19	0.63	4.47	2.44	2.44	0.70	5.39
			17	2.24	1.41	0.64	4.64	2.22	1.68	0.64	4.57	2.19	1.94	0.63	4.49	2.20	2.20	0.63	4.50	2.45	2.45	0.70	5.41
			19	-	-	-	-	3.06	1.69	0.88	7.85	3.03	1.95	0.87	7.75	3.01	2.20	0.86	7.66	2.99	2.46	0.86	7.55
			20	-	-	-	-	3.50	1.69	1.00	9.91	3.48	1.95	1.00	9.79	3.45	2.21	0.99	9.66	3.43	2.46	0.98	9.55
		4	15	1.27	1.27	0.27	0.68	1.52	1.52	0.33	0.99	1.77	1.77	0.38	1.49	2.02	2.02	0.43	2.13	2.27	2.27	0.49	2.84
			17	1.83	1.24	0.39	1.65	1.81	1.51	0.39	1.61	1.80	1.77	0.39	1.59	2.02	2.02	0.43	2.14	2.28	2.28	0.49	2.85
			19	-	-	-	-	2.65	1.51	0.57	3.77	2.63	1.78	0.57	3.72	2.61	2.03	0.56	3.67	2.59	2.29	0.56	3.61
			20	-	-	-	-	3.11	1.52	0.67	4.93	3.08	1.78	0.66	4.87	3.06	2.04	0.66	4.80	3.04	2.30	0.65	4.74
5		15	1.12	1.12	0.19	0.47	1.38	1.38	0.24	0.58	1.63	1.63	0.28	0.72	1.88	1.88	0.32	0.99	2.12	2.12	0.37	1.38	
		17	1.51	1.11	0.26	0.64	1.49	1.38	0.26	0.63	1.64	1.64	0.28	0.72	1.89	1.89	0.33	0.99	2.13	2.13	0.37	1.38	
		19	-	-	-	-	2.24	1.35	0.39	1.59	2.23	1.61	0.38	1.56	2.22	1.73	0.40	5.00	2.19	2.13	0.38	1.49	
		20	-	-	-	-	2.67	1.34	0.46	2.47	2.65	1.61	0.46	2.43	2.62	1.87	0.45	2.38	2.60	2.12	0.45	2.34	
6		15	0.98	0.98	0.14	0.34	1.24	1.24	0.18	0.43	1.49	1.49	0.21	0.51	1.74	1.74	0.25	0.60	1.99	1.99	0.29	0.74	
		17	1.16	0.98	0.17	0.40	1.23	1.22	0.18	0.42	1.49	1.49	0.21	0.51	1.75	1.75	0.25	0.60	2.00	2.00	0.29	0.74	
		19	-	-	-	-	1.92	1.22	0.28	0.69	1.90	1.49	0.27	0.68	1.87	1.75	0.27	0.67	2.00	2.00	0.29	0.74	
		20	-	-	-	-	2.30	1.20	0.33	1.06	2.29	1.47	0.33	1.04	2.27	1.73	0.33	1.01	2.25	1.99	0.32	0.99	
9		3	15	1.15	1.15	0.33	1.06	1.40	1.40	0.40	1.82	1.66	1.66	0.48	2.71	1.93	1.93	0.55	3.53	2.18	2.18	0.63	4.36
			17	1.57	1.14	0.45	2.41	1.55	1.40	0.45	2.33	1.66	1.66	0.48	2.71	1.93	1.93	0.55	3.54	2.19	2.19	0.63	4.38
			19	-	-	-	-	2.42	1.42	0.69	5.19	2.40	1.68	0.69	5.11	2.38	1.94	0.68	5.03	2.35	2.19	0.67	4.94
			20	-	-	-	-	2.86	1.42	0.82	6.92	2.84	1.69	0.82	6.83	2.82	1.95	0.81	6.74	2.80	2.20	0.80	6.65
		4	15	1.01	1.01	0.22	0.51	1.27	1.27	0.27	0.67	1.52	1.52	0.33	1.04	1.76	1.76	0.38	1.57	2.02	2.02	0.44	2.22
			17	1.22	1.00	0.26	0.64	1.26	1.24	0.27	0.67	1.52	1.52	0.33	1.04	1.77	1.77	0.38	1.58	2.02	2.02	0.44	2.24
			19	-	-	-	-	1.98	1.24	0.43	2.11	1.96	1.51	0.42	2.06	1.93	1.77	0.42	1.99	2.02	2.01	0.44	2.23
			20	-	-	-	-	2.43	1.25	0.53	3.23	2.41	1.52	0.52	3.19	2.39	1.78	0.52	3.14	2.37	2.03	0.51	3.08
	5	15	0.87	0.87	0.15	0.34	1.12	1.12	0.19	0.44	1.38	1.38	0.24	0.55	1.63	1.63	0.28	0.71	1.87	1.87	0.32	1.01	
		17	0.87	0.87	0.15	0.35	1.12	1.12	0.19	0.45	1.38	1.38	0.24	0.55	1.63	1.63	0.28	0.71	1.88	1.88	0.32	1.01	
		19	-	-	-	-	1.62	1.11	0.28	0.70	1.60	1.38	0.28	0.68	1.63	1.61	0.28	0.71	1.88	1.88	0.32	1.02	
		20	-	-	-	-	2.00	1.09	0.34	1.21	1.99	1.36	0.34	1.18	1.97	1.62	0.34	1.15	1.95	1.88	0.34	1.12	
	6	15	0.73	0.73	0.10	0.24	0.98	0.98	0.14	0.32	1.24	1.24	0.18	0.40	1.49	1.49	0.21	0.48	1.74	1.74	0.25	0.58	
		17	0.73	0.73	0.10	0.24	0.99	0.99	0.14	0.32	1.24	1.24	0.18	0.40	1.49	1.49	0.21	0.48	1.74	1.74	0.25	0.58	
		19	-	-	-	-	1.25	0.98	0.18	0.41	1.25	1.25	0.18	0.40	1.50	1.50	0.21	0.49	1.75	1.75	0.25	0.58	
		20	-	-	-	-	1.66	0.97	0.24	0.54	1.64	1.23	0.24	0.53	1.62	1.49	0.23	0.53	1.75	1.74	0.25	0.58	

Continued:

MDVF-200D304E																						
EWT	ΔT	Indoor temp (W.B.)	Indoor temperature (D.B.)																			
			21				23				25				27				29			
			TC	SC	WF	WPD	TC	SC	WF	WPD	TC	SC	WF	WPD	TC	SC	WF	WPD	TC	SC	WF	WPD
°C	°C	°C	kW	kW	m³/h	kPa	kW	kW	m³/h	kPa	kW	kW	m³/h	kPa	kW	kW	m³/h	kPa	kW	kW	m³/h	kPa
11	3	15	0.89	0.89	0.25	0.59	1.14	1.14	0.33	1.05	1.40	1.40	0.40	1.81	1.66	1.66	0.47	2.66	1.92	1.92	0.55	3.42
		17	0.93	0.89	0.26	0.63	1.15	1.15	0.33	1.06	1.40	1.40	0.40	1.82	1.67	1.67	0.47	2.67	1.93	1.93	0.55	3.43
		19	-	-	-	-	1.71	1.14	0.49	2.80	1.69	1.41	0.48	2.74	1.68	1.68	0.48	2.73	1.93	1.93	0.55	3.44
		20	-	-	-	-	2.17	1.15	0.62	4.19	2.15	1.42	0.61	4.13	2.13	1.68	0.61	4.05	2.10	1.93	0.60	3.97
	4	15	0.75	0.75	0.16	0.36	1.01	1.01	0.22	0.48	1.26	1.26	0.27	0.66	1.51	1.51	0.32	1.04	1.76	1.76	0.38	1.58
		17	0.75	0.75	0.16	0.36	1.01	1.01	0.22	0.48	1.27	1.27	0.27	0.66	1.51	1.51	0.32	1.05	1.76	1.76	0.38	1.59
		19	-	-	-	-	1.31	1.00	0.28	0.72	1.30	1.27	0.28	0.70	1.52	1.52	0.32	1.05	1.77	1.77	0.38	1.60
		20	-	-	-	-	1.71	0.98	0.37	1.45	1.69	1.25	0.36	1.41	1.67	1.51	0.36	1.36	1.76	1.75	0.38	1.58
	5	15	0.61	0.61	0.11	0.23	0.87	0.87	0.15	0.33	1.13	1.13	0.19	0.42	1.38	1.38	0.24	0.52	1.63	1.63	0.28	0.72
		17	0.62	0.62	0.11	0.23	0.87	0.87	0.15	0.33	1.13	1.13	0.19	0.42	1.38	1.38	0.24	0.53	1.63	1.63	0.28	0.72
		19	-	-	-	-	0.95	0.87	0.16	0.36	1.13	1.13	0.19	0.42	1.38	1.38	0.24	0.53	1.63	1.63	0.28	0.73
		20	-	-	-	-	1.35	0.86	0.23	0.51	1.33	1.12	0.23	0.50	1.37	1.35	0.24	0.52	1.64	1.64	0.28	0.73
6	15	0.48	0.48	0.07	0.15	0.73	0.73	0.11	0.23	0.99	0.99	0.14	0.30	1.24	1.24	0.18	0.38	1.49	1.49	0.21	0.46	
	17	0.48	0.48	0.07	0.15	0.73	0.73	0.11	0.23	0.99	0.99	0.14	0.30	1.24	1.24	0.18	0.38	1.49	1.49	0.21	0.46	
	19	-	-	-	-	0.74	0.74	0.11	0.23	0.99	0.99	0.14	0.30	1.24	1.24	0.18	0.38	1.50	1.50	0.21	0.46	
	20	-	-	-	-	0.96	0.73	0.14	0.29	0.98	0.95	0.14	0.30	1.25	1.25	0.18	0.38	1.50	1.50	0.22	0.46	
13	3	15	0.63	0.63	0.18	0.39	0.89	0.89	0.26	0.59	1.14	1.14	0.33	1.11	1.40	1.40	0.40	1.90	1.66	1.66	0.48	2.66
		17	0.63	0.63	0.18	0.39	0.89	0.89	0.26	0.59	1.15	1.15	0.33	1.12	1.40	1.40	0.40	1.90	1.67	1.67	0.48	2.67
		19	-	-	-	-	1.00	0.89	0.29	0.77	1.15	1.15	0.33	1.13	1.41	1.41	0.40	1.92	1.67	1.67	0.48	2.68
		20	-	-	-	-	1.41	0.88	0.40	1.92	1.39	1.14	0.40	1.86	1.41	1.39	0.40	1.91	1.67	1.67	0.48	2.69
	4	15	0.49	0.49	0.11	0.22	0.75	0.75	0.16	0.34	1.01	1.01	0.22	0.46	1.26	1.26	0.27	0.67	1.51	1.51	0.32	1.09
		17	0.49	0.49	0.11	0.22	0.75	0.75	0.16	0.34	1.01	1.01	0.22	0.46	1.26	1.26	0.27	0.68	1.51	1.51	0.32	1.10
		19	-	-	-	-	0.75	0.74	0.16	0.34	1.01	1.01	0.22	0.46	1.27	1.27	0.27	0.68	1.51	1.51	0.33	1.11
		20	-	-	-	-	1.02	0.75	0.22	0.46	1.02	1.01	0.22	0.46	1.27	1.27	0.27	0.68	1.51	1.51	0.33	1.11
	5	15	0.36	0.36	0.06	0.13	0.61	0.61	0.11	0.22	0.87	0.87	0.15	0.31	1.12	1.12	0.19	0.40	1.37	1.37	0.24	0.50
		17	0.36	0.36	0.06	0.13	0.61	0.61	0.11	0.22	0.87	0.87	0.15	0.31	1.12	1.12	0.19	0.40	1.38	1.38	0.24	0.51
		19	-	-	-	-	0.62	0.62	0.11	0.22	0.87	0.87	0.15	0.31	1.13	1.13	0.19	0.40	1.38	1.38	0.24	0.51
		20	-	-	-	-	0.63	0.62	0.11	0.22	0.87	0.87	0.15	0.31	1.13	1.13	0.19	0.40	1.38	1.38	0.24	0.51
6	15	0.23	0.23	0.03	0.07	0.48	0.48	0.07	0.14	0.73	0.73	0.10	0.21	0.99	0.99	0.14	0.29	1.24	1.24	0.18	0.36	
	17	0.23	0.23	0.03	0.07	0.48	0.48	0.07	0.14	0.74	0.74	0.11	0.21	0.99	0.99	0.14	0.29	1.24	1.24	0.18	0.36	
	19	-	-	-	-	0.48	0.48	0.07	0.14	0.74	0.74	0.11	0.21	0.99	0.99	0.14	0.29	1.24	1.24	0.18	0.36	
	20	-	-	-	-	0.48	0.48	0.07	0.14	0.74	0.74	0.11	0.21	0.99	0.99	0.14	0.29	1.24	1.24	0.18	0.36	
15	3	15	0.37	0.37	0.11	0.21	0.63	0.63	0.18	0.37	0.89	0.89	0.25	0.58	1.14	1.14	0.32	1.12	1.40	1.40	0.40	1.88
		17	0.37	0.37	0.11	0.22	0.63	0.63	0.18	0.37	0.89	0.89	0.25	0.58	1.14	1.14	0.32	1.13	1.40	1.40	0.40	1.89
		19	-	-	-	-	0.63	0.63	0.18	0.37	0.89	0.89	0.25	0.58	1.14	1.14	0.33	1.14	1.40	1.40	0.40	1.90
		20	-	-	-	-	0.68	0.63	0.19	0.39	0.89	0.89	0.25	0.58	1.14	1.14	0.33	1.14	1.40	1.40	0.40	1.91
	4	15	0.24	0.24	0.05	0.10	0.49	0.49	0.11	0.21	0.75	0.75	0.16	0.32	1.01	1.01	0.22	0.43	1.26	1.26	0.27	0.68
		17	0.24	0.24	0.05	0.10	0.49	0.49	0.11	0.21	0.75	0.75	0.16	0.32	1.01	1.01	0.22	0.44	1.26	1.26	0.27	0.69
		19	-	-	-	-	0.50	0.50	0.11	0.21	0.75	0.75	0.16	0.32	1.01	1.01	0.22	0.44	1.26	1.26	0.27	0.69
		20	-	-	-	-	0.50	0.50	0.11	0.21	0.75	0.75	0.16	0.32	1.01	1.01	0.22	0.44	1.26	1.26	0.27	0.69
	5	15	0.13	0.13	0.02	0.04	0.36	0.36	0.06	0.12	0.62	0.62	0.11	0.21	0.87	0.87	0.15	0.29	1.12	1.12	0.19	0.38
		17	0.13	0.13	0.02	0.04	0.36	0.36	0.06	0.12	0.62	0.62	0.11	0.21	0.87	0.87	0.15	0.30	1.13	1.13	0.19	0.38
		19	-	-	-	-	0.36	0.36	0.06	0.12	0.62	0.62	0.11	0.21	0.87	0.87	0.15	0.30	1.13	1.13	0.19	0.38
		20	-	-	-	-	0.37	0.37	0.06	0.12	0.62	0.62	0.11	0.21	0.87	0.87	0.15	0.30	1.13	1.13	0.19	0.38
6	15	-	-	-	-	0.24	0.24	0.03	0.07	0.48	0.48	0.07	0.13	0.74	0.74	0.11	0.20	0.99	0.99	0.14	0.27	
	17	-	-	-	-	0.24	0.24	0.03	0.07	0.49	0.49	0.07	0.13	0.74	0.74	0.11	0.20	0.99	0.99	0.14	0.27	
	19	-	-	-	-	0.24	0.24	0.03	0.07	0.49	0.49	0.07	0.13	0.74	0.74	0.11	0.21	0.99	0.99	0.14	0.28	
	20	-	-	-	-	0.24	0.24	0.03	0.07	0.49	0.49	0.07	0.13	0.74	0.74	0.11	0.21	0.99	0.99	0.14	0.28	

Cooling capacity

MDVF-300D304E																							
EWT	ΔT	Indoor temp (W.B.)	Indoor temperature (D.B.)																				
			21				23				25				27				29				
			TC	SC	WF	WPD	TC	SC	WF	WPD	TC	SC	WF	WPD	TC	SC	WF	WPD	TC	SC	WF	WPD	
°C	°C	°C	kW	kW	m ³ /h	kPa	kW	kW	m ³ /h	kPa	kW	kW	m ³ /h	kPa	kW	kW	m ³ /h	kPa	kW	kW	m ³ /h	kPa	
5	3	15	2.80	2.26	0.81	8.25	2.77	2.62	0.80	8.09	2.96	2.96	0.85	9.06	3.31	3.31	0.95	10.93	3.65	3.65	1.05	12.92	
		17	3.85	2.27	1.11	14.18	3.82	2.62	1.10	14.01	3.80	2.97	1.09	13.84	3.77	3.31	1.08	13.65	3.73	3.65	1.07	13.42	
		19	-	-	-	-	4.94	2.63	1.42	21.81	4.91	2.98	1.41	21.56	4.88	3.33	1.40	21.31	4.84	3.67	1.39	21.07	
		20	-	-	-	-	5.53	2.64	1.59	26.45	5.50	2.99	1.58	26.24	5.46	3.33	1.57	25.94	5.43	3.67	1.56	25.65	
	4	15	2.27	2.03	0.49	3.32	2.38	2.37	0.51	3.69	2.74	2.74	0.59	4.83	3.09	3.09	0.66	5.91	3.43	3.43	0.74	7.07	
		17	3.36	2.05	0.72	6.81	3.33	2.40	0.72	6.73	3.30	2.75	0.71	6.63	3.27	3.10	0.70	6.51	3.44	3.44	0.74	7.10	
		19	-	-	-	-	4.45	2.41	0.95	10.92	4.42	2.76	0.95	10.79	4.39	3.11	0.94	10.66	4.36	3.45	0.93	10.54	
		20	-	-	-	-	5.04	2.42	1.08	13.54	5.01	2.77	1.07	13.38	4.98	3.11	1.07	13.23	4.94	3.45	1.06	13.08	
	5	15	1.87	1.85	0.32	1.11	2.18	2.18	0.37	1.66	2.52	2.52	0.43	2.44	2.86	2.86	0.49	3.37	3.21	3.21	0.55	4.26	
		17	2.81	1.81	0.48	3.22	2.78	2.17	0.48	3.16	2.75	2.52	0.47	3.08	2.86	2.85	0.49	3.37	3.21	3.21	0.55	4.28	
		19	-	-	-	-	3.93	2.19	0.67	6.03	3.91	2.54	0.67	5.95	3.88	2.88	0.66	5.88	3.85	3.23	0.66	5.80	
		20	-	-	-	-	4.54	2.20	0.78	7.68	4.51	2.55	0.77	7.59	4.47	2.89	0.77	7.50	4.44	3.24	0.76	7.41	
	6	15	1.67	1.67	0.24	0.72	2.01	2.01	0.29	0.89	2.34	2.34	0.33	1.24	2.66	2.66	0.38	1.76	2.99	2.99	0.43	2.41	
		17	2.38	1.63	0.34	1.29	2.35	1.99	0.34	1.26	2.35	2.34	0.34	1.25	2.67	2.67	0.38	1.76	3.00	3.00	0.43	2.42	
		19	-	-	-	-	3.38	1.96	0.48	3.26	3.35	2.31	0.48	3.20	3.32	2.66	0.48	3.14	3.29	3.00	0.47	3.06	
		20	-	-	-	-	4.00	1.97	0.57	4.53	3.97	2.32	0.57	4.47	3.94	2.67	0.56	4.41	3.91	3.01	0.56	4.35	
	7	3	15	1.97	1.90	0.57	4.46	2.25	2.25	0.65	5.56	2.61	2.61	0.75	7.12	2.95	2.95	0.85	8.81	3.30	3.30	0.94	10.63
			17	3.04	1.91	0.87	9.26	3.02	2.27	0.86	9.13	2.99	2.62	0.86	8.98	2.97	2.96	0.85	8.89	3.30	3.30	0.95	10.67
			19	-	-	-	-	4.15	2.28	1.20	15.98	4.12	2.63	1.19	15.78	4.09	2.98	1.18	15.60	4.06	3.32	1.17	15.40
			20	-	-	-	-	4.74	2.28	1.37	20.11	4.71	2.63	1.36	19.87	4.67	2.98	1.35	19.63	4.64	3.32	1.34	19.40
		4	15	1.69	1.69	0.36	1.59	2.03	2.03	0.44	2.57	2.38	2.38	0.51	3.72	2.74	2.74	0.59	4.74	3.08	3.08	0.66	5.81
			17	2.50	1.69	0.54	4.07	2.48	2.04	0.53	3.99	2.45	2.39	0.53	3.90	2.74	2.74	0.59	4.75	3.09	3.09	0.67	5.82
			19	-	-	-	-	3.63	2.06	0.78	7.66	3.60	2.41	0.78	7.56	3.58	2.76	0.77	7.46	3.54	3.10	0.76	7.35
			20	-	-	-	-	4.23	2.06	0.91	9.93	4.20	2.42	0.90	9.81	4.17	2.76	0.90	9.69	4.14	3.11	0.89	9.57
5		15	1.52	1.52	0.26	0.77	1.85	1.85	0.32	1.13	2.18	2.18	0.38	1.75	2.52	2.52	0.43	2.54	2.86	2.86	0.49	3.42	
		17	2.01	1.49	0.35	1.41	1.99	1.85	0.34	1.37	2.19	2.19	0.38	1.76	2.52	2.52	0.43	2.55	2.87	2.87	0.49	3.43	
		19	-	-	-	-	3.07	1.83	0.53	3.90	3.04	2.18	0.52	3.84	3.04	2.44	0.55	10.00	2.98	2.88	0.51	3.69	
		20	-	-	-	-	3.68	1.84	0.63	5.32	3.65	2.20	0.63	5.25	3.63	2.55	0.62	5.18	3.60	2.89	0.62	5.11	
6		15	1.33	1.33	0.19	0.54	1.67	1.67	0.24	0.69	2.01	2.01	0.29	0.90	2.34	2.34	0.34	1.30	2.66	2.66	0.38	1.86	
		17	1.58	1.32	0.23	0.65	1.66	1.63	0.24	0.68	2.01	2.01	0.29	0.90	2.34	2.34	0.34	1.31	2.67	2.67	0.38	1.87	
		19	-	-	-	-	2.54	1.63	0.37	1.64	2.52	1.98	0.36	1.60	2.49	2.33	0.36	1.55	2.67	2.67	0.38	1.88	
		20	-	-	-	-	3.10	1.62	0.45	2.75	3.07	1.97	0.44	2.70	3.05	2.32	0.44	2.64	3.01	2.67	0.43	2.57	
9		3	15	1.54	1.54	0.44	2.69	1.90	1.90	0.54	4.10	2.26	2.26	0.65	5.48	2.61	2.61	0.75	7.01	2.95	2.95	0.85	8.67
			17	2.17	1.55	0.62	5.15	2.14	1.91	0.61	5.03	2.25	2.24	0.65	5.47	2.61	2.61	0.75	7.03	2.96	2.96	0.85	8.70
			19	-	-	-	-	3.29	1.92	0.94	10.42	3.26	2.27	0.94	10.28	3.23	2.62	0.93	10.13	3.20	2.96	0.92	9.94
			20	-	-	-	-	3.88	1.92	1.11	13.85	3.85	2.27	1.10	13.68	3.82	2.62	1.10	13.51	3.79	2.97	1.09	13.33
		4	15	1.36	1.36	0.29	0.93	1.69	1.69	0.37	1.66	2.03	2.03	0.44	2.69	2.39	2.39	0.52	3.72	2.73	2.73	0.59	4.64
			17	1.63	1.34	0.35	1.49	1.68	1.64	0.36	1.63	2.04	2.04	0.44	2.71	2.39	2.39	0.52	3.74	2.74	2.74	0.59	4.66
			19	-	-	-	-	2.72	1.70	0.59	4.61	2.70	2.05	0.58	4.53	2.68	2.40	0.58	4.51	2.73	2.70	0.59	4.63
			20	-	-	-	-	3.33	1.71	0.72	6.49	3.31	2.06	0.71	6.40	3.28	2.41	0.71	6.31	3.25	2.76	0.70	6.21
	5	15	1.17	1.17	0.20	0.55	1.51	1.51	0.26	0.74	1.85	1.85	0.32	1.15	2.18	2.18	0.37	1.80	2.52	2.52	0.43	2.61	
		17	1.20	1.17	0.21	0.56	1.52	1.52	0.26	0.74	1.85	1.85	0.32	1.16	2.18	2.18	0.38	1.81	2.52	2.52	0.43	2.63	
		19	-	-	-	-	2.15	1.48	0.37	1.74	2.12	1.84	0.37	1.68	2.17	2.13	0.37	1.79	2.53	2.53	0.43	2.64	
		20	-	-	-	-	2.73	1.48	0.47	3.13	2.71	1.83	0.47	3.07	2.68	2.18	0.46	3.00	2.64	2.53	0.45	2.92	
	6	15	0.99	0.99	0.14	0.38	1.33	1.33	0.19	0.51	1.67	1.67	0.24	0.65	2.01	2.01	0.29	0.90	2.33	2.33	0.33	1.34	
		17	0.99	0.99	0.14	0.38	1.33	1.33	0.19	0.52	1.68	1.68	0.24	0.65	2.01	2.01	0.29	0.90	2.33	2.33	0.33	1.34	
		19	-	-	-	-	1.71	1.32	0.24	0.67	1.70	1.68	0.24	0.66	2.01	2.01	0.29	0.91	2.34	2.34	0.34	1.35	
		20	-	-	-	-	2.22	1.29	0.32	1.17	2.20	1.65	0.31	1.14	2.17	2.00	0.31	1.11	2.34	2.34	0.34	1.36	

Continued:

MDVF-300D304E																						
EWT	ΔT	Indoor temp (W.B.)	Indoor temperature (D.B.)																			
			21				23				25				27				29			
			TC	SC	WF	WPD	TC	SC	WF	WPD	TC	SC	WF	WPD	TC	SC	WF	WPD	TC	SC	WF	WPD
°C	°C	°C	kW	kW	m³/h	kPa	kW	kW	m³/h	kPa	kW	kW	m³/h	kPa	kW	kW	m³/h	kPa	kW	kW	m³/h	kPa
11	3	15	1.19	1.19	0.34	1.39	1.54	1.54	0.44	2.70	1.90	1.90	0.54	3.98	2.25	2.25	0.64	5.32	2.60	2.60	0.74	6.79
		17	1.23	1.19	0.35	1.53	1.54	1.54	0.44	2.72	1.90	1.90	0.54	4.00	2.26	2.26	0.64	5.34	2.60	2.60	0.74	6.81
		19	-	-	-	-	2.36	1.56	0.67	5.74	2.33	1.91	0.66	5.62	2.31	2.26	0.66	5.54	2.61	2.61	0.74	6.84
		20	-	-	-	-	2.96	1.56	0.84	8.47	2.93	1.92	0.84	8.34	2.90	2.27	0.83	8.20	2.87	2.61	0.82	8.04
	4	15	1.01	1.01	0.22	0.57	1.35	1.35	0.29	0.92	1.69	1.69	0.36	1.67	2.03	2.03	0.44	2.67	2.39	2.39	0.51	3.60
		17	1.01	1.01	0.22	0.57	1.36	1.36	0.29	0.92	1.69	1.69	0.36	1.68	2.04	2.04	0.44	2.69	2.39	2.39	0.51	3.61
		19	-	-	-	-	1.74	1.34	0.37	1.83	1.73	1.69	0.37	1.79	2.04	2.04	0.44	2.70	2.40	2.40	0.51	3.62
		20	-	-	-	-	2.36	1.34	0.51	3.53	2.33	1.70	0.50	3.46	2.30	2.05	0.49	3.38	2.38	2.35	0.51	3.59
	5	15	0.83	0.83	0.14	0.37	1.18	1.18	0.20	0.53	1.52	1.52	0.26	0.73	1.85	1.85	0.32	1.20	2.18	2.18	0.37	1.88
		17	0.83	0.83	0.14	0.37	1.18	1.18	0.20	0.53	1.52	1.52	0.26	0.73	1.85	1.85	0.32	1.20	2.18	2.18	0.38	1.88
		19	-	-	-	-	1.30	1.18	0.22	0.58	1.52	1.52	0.26	0.74	1.85	1.85	0.32	1.21	2.19	2.19	0.38	1.90
		20	-	-	-	-	1.80	1.15	0.31	1.12	1.78	1.51	0.31	1.09	1.84	1.79	0.32	1.18	2.19	2.19	0.38	1.90
6	15	0.66	0.66	0.09	0.24	1.00	1.00	0.14	0.36	1.34	1.34	0.19	0.49	1.68	1.68	0.24	0.63	2.00	2.00	0.29	0.93	
	17	0.66	0.66	0.09	0.24	1.00	1.00	0.14	0.36	1.34	1.34	0.19	0.49	1.68	1.68	0.24	0.63	2.01	2.01	0.29	0.93	
	19	-	-	-	-	1.00	0.98	0.14	0.36	1.34	1.34	0.19	0.49	1.68	1.68	0.24	0.63	2.01	2.01	0.29	0.94	
	20	-	-	-	-	1.32	0.98	0.19	0.48	1.34	1.33	0.19	0.49	1.68	1.68	0.24	0.63	2.01	2.01	0.29	0.94	
13	3	15	0.85	0.85	0.24	0.65	1.19	1.19	0.34	1.48	1.54	1.54	0.44	2.78	1.90	1.90	0.55	3.98	2.25	2.25	0.65	5.30
		17	0.85	0.85	0.25	0.65	1.19	1.19	0.34	1.49	1.55	1.55	0.44	2.79	1.91	1.91	0.55	3.99	2.26	2.26	0.65	5.32
		19	-	-	-	-	1.33	1.19	0.38	2.00	1.55	1.55	0.44	2.80	1.91	1.91	0.55	4.01	2.26	2.26	0.65	5.34
		20	-	-	-	-	1.96	1.20	0.56	4.19	1.93	1.56	0.55	4.09	1.92	1.91	0.55	4.06	2.26	2.26	0.65	5.35
	4	15	0.67	0.67	0.14	0.36	1.01	1.01	0.22	0.55	1.35	1.35	0.29	0.97	1.69	1.69	0.36	1.76	2.04	2.04	0.44	2.72
		17	0.67	0.67	0.14	0.36	1.02	1.02	0.22	0.55	1.35	1.35	0.29	0.97	1.69	1.69	0.36	1.77	2.04	2.04	0.44	2.73
		19	-	-	-	-	1.01	0.98	0.22	0.55	1.36	1.36	0.29	0.98	1.69	1.69	0.36	1.78	2.05	2.05	0.44	2.74
		20	-	-	-	-	1.36	1.00	0.29	0.99	1.37	1.36	0.29	0.99	1.70	1.70	0.36	1.79	2.05	2.05	0.44	2.75
	5	15	0.49	0.49	0.08	0.21	0.83	0.83	0.14	0.35	1.17	1.17	0.20	0.50	1.51	1.51	0.26	0.73	1.84	1.84	0.32	1.22
		17	0.49	0.49	0.08	0.21	0.83	0.83	0.14	0.35	1.18	1.18	0.20	0.50	1.52	1.52	0.26	0.73	1.84	1.84	0.32	1.23
		19	-	-	-	-	0.83	0.83	0.14	0.35	1.18	1.18	0.20	0.50	1.52	1.52	0.26	0.73	1.85	1.85	0.32	1.23
		20	-	-	-	-	0.88	0.83	0.15	0.37	1.18	1.18	0.20	0.50	1.52	1.52	0.26	0.73	1.85	1.85	0.32	1.24
6	15	0.32	0.32	0.05	0.11	0.66	0.66	0.09	0.23	1.00	1.00	0.14	0.34	1.34	1.34	0.19	0.46	1.67	1.67	0.24	0.62	
	17	0.32	0.32	0.05	0.11	0.66	0.66	0.09	0.23	1.00	1.00	0.14	0.35	1.34	1.34	0.19	0.46	1.68	1.68	0.24	0.62	
	19	-	-	-	-	0.66	0.66	0.09	0.23	1.00	1.00	0.14	0.35	1.34	1.34	0.19	0.46	1.68	1.68	0.24	0.62	
	20	-	-	-	-	0.66	0.65	0.09	0.23	1.00	1.00	0.14	0.35	1.34	1.34	0.19	0.47	1.68	1.68	0.24	0.62	
15	3	15	0.50	0.50	0.14	0.35	0.85	0.85	0.24	0.63	1.19	1.19	0.34	1.49	1.54	1.54	0.44	2.71	1.90	1.90	0.54	3.85
		17	0.50	0.50	0.14	0.35	0.85	0.85	0.24	0.63	1.19	1.19	0.34	1.50	1.54	1.54	0.44	2.72	1.90	1.90	0.54	3.87
		19	-	-	-	-	0.85	0.85	0.24	0.63	1.19	1.19	0.34	1.51	1.55	1.55	0.44	2.73	1.90	1.90	0.54	3.88
		20	-	-	-	-	0.92	0.85	0.26	0.74	1.19	1.19	0.34	1.51	1.55	1.55	0.44	2.74	1.91	1.91	0.54	3.89
	4	15	0.33	0.33	0.07	0.17	0.67	0.67	0.14	0.34	1.01	1.01	0.22	0.52	1.35	1.35	0.29	0.98	1.68	1.68	0.36	1.79
		17	0.33	0.33	0.07	0.17	0.67	0.67	0.14	0.34	1.02	1.02	0.22	0.52	1.35	1.35	0.29	0.99	1.69	1.69	0.36	1.80
		19	-	-	-	-	0.67	0.67	0.14	0.34	1.02	1.02	0.22	0.53	1.35	1.35	0.29	0.99	1.69	1.69	0.36	1.81
		20	-	-	-	-	0.67	0.67	0.14	0.34	1.02	1.02	0.22	0.53	1.35	1.35	0.29	1.00	1.69	1.69	0.36	1.81
	5	15	0.16	0.16	0.03	0.06	0.50	0.50	0.09	0.20	0.84	0.84	0.14	0.34	1.18	1.18	0.20	0.48	1.51	1.51	0.26	0.75
		17	0.16	0.16	0.03	0.06	0.50	0.50	0.09	0.20	0.84	0.84	0.14	0.34	1.18	1.18	0.20	0.48	1.52	1.52	0.26	0.76
		19	-	-	-	-	0.50	0.50	0.09	0.20	0.84	0.84	0.14	0.34	1.18	1.18	0.20	0.48	1.52	1.52	0.26	0.76
		20	-	-	-	-	0.50	0.50	0.09	0.20	0.84	0.84	0.14	0.34	1.18	1.18	0.20	0.48	1.52	1.52	0.26	0.76
6	15	-	-	-	-	0.32	0.32	0.05	0.11	0.66	0.66	0.09	0.22	1.00	1.00	0.14	0.33	1.34	1.34	0.19	0.44	
	17	-	-	-	-	0.33	0.33	0.05	0.11	0.66	0.66	0.10	0.22	1.00	1.00	0.14	0.33	1.34	1.34	0.19	0.44	
	19	-	-	-	-	0.33	0.33	0.05	0.11	0.66	0.66	0.10	0.22	1.00	1.00	0.14	0.33	1.34	1.34	0.19	0.44	
	20	-	-	-	-	0.33	0.33	0.05	0.11	0.66	0.66	0.10	0.22	1.00	1.00	0.14	0.33	1.35	1.35	0.19	0.44	

Cooling capacity

MDVF-400D304E																							
EWT	ΔT	Indoor temp (W.B.)	Indoor temperature (D.B.)																				
			21				23				25				27				29				
			TC	SC	WF	WPD	TC	SC	WF	WPD	TC	SC	WF	WPD	TC	SC	WF	WPD	TC	SC	WF	WPD	
°C	°C	°C	kW	kW	m ³ /h	kPa	kW	kW	m ³ /h	kPa	kW	kW	m ³ /h	kPa	kW	kW	m ³ /h	kPa	kW	kW	m ³ /h	kPa	
5	3	15	3.42	2.74	0.98	13.41	3.38	3.16	0.97	13.17	3.58	3.58	1.03	14.49	3.98	3.98	1.14	17.23	4.39	4.39	1.26	20.66	
		17	4.67	2.75	1.34	22.93	4.64	3.17	1.33	22.66	4.60	3.59	1.32	22.39	4.57	4.00	1.31	22.09	4.53	4.40	1.30	21.73	
		19	-	-	-	-	5.96	3.17	1.71	34.68	5.93	3.59	1.69	34.28	5.89	4.00	1.68	33.89	5.85	4.41	1.67	33.51	
		20	-	-	-	-	6.68	3.18	1.91	42.16	6.64	3.60	1.91	41.99	6.59	4.01	1.89	41.54	6.55	4.42	1.88	41.07	
	4	15	2.83	2.48	0.61	5.92	2.89	2.86	0.62	6.12	3.32	3.32	0.72	7.76	3.74	3.74	0.80	9.49	4.14	4.14	0.89	11.21	
		17	4.10	2.49	0.88	10.99	4.07	2.91	0.87	10.86	4.03	3.33	0.86	10.71	4.00	3.74	0.86	10.53	4.15	4.15	0.89	11.24	
		19	-	-	-	-	5.42	2.93	1.17	17.94	5.39	3.35	1.16	17.74	5.35	3.76	1.15	17.53	5.31	4.17	1.14	17.33	
		20	-	-	-	-	6.13	2.93	1.32	22.16	6.09	3.35	1.31	21.92	6.05	3.77	1.30	21.67	6.01	4.18	1.29	21.42	
	5	15	2.26	2.23	0.39	2.13	2.64	2.64	0.45	3.20	3.06	3.06	0.53	4.51	3.47	3.47	0.60	5.67	3.89	3.89	0.67	6.86	
		17	3.49	2.22	0.60	5.71	3.46	2.65	0.59	5.63	3.42	3.07	0.59	5.52	3.47	3.44	0.59	5.64	3.90	3.90	0.67	6.88	
		19	-	-	-	-	4.83	2.67	0.83	9.92	4.80	3.09	0.82	9.80	4.76	3.51	0.82	9.68	4.73	3.92	0.81	9.55	
		20	-	-	-	-	5.55	2.68	0.95	12.55	5.51	3.10	0.95	12.41	5.47	3.51	0.94	12.26	5.44	3.93	0.93	12.12	
	6	15	2.03	2.03	0.29	1.05	2.43	2.43	0.35	1.59	2.82	2.82	0.40	2.37	3.22	3.22	0.46	3.37	3.64	3.64	0.52	4.43	
		17	2.89	1.97	0.41	2.54	2.86	2.40	0.41	2.47	2.84	2.82	0.41	2.43	3.23	3.23	0.46	3.39	3.64	3.64	0.52	4.44	
		19	-	-	-	-	4.22	2.41	0.60	5.76	4.19	2.83	0.60	5.69	4.15	3.25	0.59	5.61	4.11	3.66	0.59	5.52	
		20	-	-	-	-	4.95	2.42	0.71	7.55	4.91	2.85	0.70	7.46	4.88	3.26	0.70	7.37	4.84	3.68	0.69	7.28	
	7	3	15	2.43	2.30	0.70	7.34	2.73	2.73	0.78	8.93	3.15	3.15	0.90	11.41	3.57	3.57	1.02	14.10	3.98	3.98	1.15	17.25
			17	3.72	2.32	1.07	15.33	3.69	2.75	1.06	15.13	3.64	3.16	1.04	14.62	3.61	3.57	1.04	14.43	3.99	3.99	1.15	17.30
			19	-	-	-	-	5.01	2.75	1.44	25.38	4.98	3.17	1.43	25.08	4.94	3.58	1.42	24.78	4.91	3.99	1.41	24.48
			20	-	-	-	-	5.73	2.76	1.66	32.45	5.69	3.18	1.65	32.08	5.66	3.59	1.63	31.70	5.62	4.00	1.62	31.34
		4	15	2.04	2.04	0.44	3.03	2.47	2.47	0.53	4.61	2.90	2.90	0.62	6.06	3.32	3.32	0.72	7.62	3.73	3.73	0.80	9.31
			17	3.11	2.06	0.67	6.81	3.07	2.49	0.66	6.69	3.04	2.91	0.66	6.57	3.33	3.33	0.72	7.65	3.74	3.74	0.81	9.34
			19	-	-	-	-	4.44	2.50	0.96	12.58	4.41	2.92	0.95	12.42	4.37	3.34	0.95	12.27	4.34	3.75	0.94	12.08
			20	-	-	-	-	5.15	2.51	1.11	16.23	5.11	2.93	1.10	16.04	5.08	3.35	1.10	15.85	5.04	3.76	1.09	15.66
5		15	1.84	1.84	0.32	1.28	2.23	2.23	0.38	2.15	2.64	2.64	0.45	3.31	3.06	3.06	0.53	4.51	3.48	3.48	0.60	5.61	
		17	2.45	1.80	0.42	2.75	2.42	2.22	0.42	2.66	2.64	2.64	0.45	3.33	3.07	3.07	0.53	4.52	3.49	3.49	0.60	5.63	
		19	-	-	-	-	3.81	2.25	0.66	6.53	3.78	2.67	0.65	6.44	3.71	2.97	0.67	15.00	3.70	3.50	0.64	6.23	
		20	-	-	-	-	4.53	2.25	0.78	8.77	4.50	2.68	0.77	8.66	4.46	3.10	0.77	8.55	4.43	3.51	0.76	8.44	
6		15	1.62	1.62	0.23	0.77	2.03	2.03	0.29	1.06	2.42	2.42	0.35	1.67	2.82	2.82	0.41	2.52	3.23	3.23	0.46	3.51	
		17	1.97	1.61	0.28	0.99	2.02	2.00	0.29	1.05	2.43	2.43	0.35	1.68	2.82	2.82	0.41	2.53	3.24	3.24	0.47	3.53	
		19	-	-	-	-	3.14	1.98	0.45	3.29	3.11	2.41	0.45	3.21	3.07	2.83	0.44	3.12	3.24	3.23	0.47	3.53	
		20	-	-	-	-	3.87	1.99	0.55	4.89	3.84	2.42	0.55	4.83	3.80	2.84	0.54	4.75	3.76	3.25	0.54	4.67	
9		3	15	1.87	1.87	0.54	4.64	2.30	2.30	0.66	6.60	2.73	2.73	0.78	8.79	3.15	3.15	0.90	11.22	3.56	3.56	1.02	13.86
			17	2.67	1.89	0.77	8.49	2.64	2.31	0.76	8.31	2.72	2.68	0.78	8.74	3.15	3.15	0.90	11.26	3.56	3.56	1.02	13.90
			19	-	-	-	-	4.00	2.32	1.15	17.04	3.97	2.75	1.14	16.82	3.93	3.16	1.13	16.57	3.89	3.58	1.12	16.28
			20	-	-	-	-	4.70	2.32	1.35	22.42	4.67	2.75	1.34	22.14	4.64	3.17	1.33	21.87	4.60	3.58	1.32	21.58
		4	15	1.63	1.63	0.35	1.76	2.05	2.05	0.44	3.17	2.47	2.47	0.53	4.54	2.90	2.90	0.62	5.93	3.31	3.31	0.71	7.46
			17	2.00	1.62	0.43	3.00	2.03	2.00	0.44	3.12	2.48	2.48	0.53	4.55	2.90	2.90	0.62	5.95	3.32	3.32	0.71	7.48
			19	-	-	-	-	3.37	2.07	0.72	7.66	3.33	2.49	0.72	7.53	3.30	2.91	0.71	7.39	3.31	3.29	0.71	7.46
			20	-	-	-	-	4.08	2.08	0.88	10.65	4.05	2.50	0.87	10.51	4.02	2.92	0.86	10.37	3.98	3.34	0.86	10.20
	5	15	1.43	1.43	0.25	0.79	1.83	1.83	0.31	1.30	2.23	2.23	0.38	2.22	2.64	2.64	0.45	3.38	3.07	3.07	0.53	4.45	
		17	1.50	1.43	0.26	0.84	1.83	1.83	0.32	1.31	2.23	2.23	0.38	2.23	2.65	2.65	0.46	3.40	3.07	3.07	0.53	4.47	
		19	-	-	-	-	2.67	1.81	0.46	3.46	2.64	2.23	0.45	3.36	2.64	2.63	0.45	3.38	3.08	3.08	0.53	4.48	
		20	-	-	-	-	3.42	1.82	0.59	5.36	3.39	2.25	0.58	5.27	3.35	2.67	0.58	5.18	3.32	3.09	0.57	5.08	
	6	15	1.21	1.21	0.17	0.54	1.62	1.62	0.23	0.73	2.03	2.03	0.29	1.07	2.42	2.42	0.35	1.72	2.82	2.82	0.40	2.58	
		17	1.21	1.20	0.17	0.54	1.63	1.63	0.23	0.73	2.03	2.03	0.29	1.07	2.42	2.42	0.35	1.72	2.82	2.82	0.40	2.59	
		19	-	-	-	-	2.10	1.60	0.30	1.17	2.10	2.03	0.30	1.17	2.43	2.43	0.35	1.73	2.83	2.83	0.41	2.60	
		20	-	-	-	-	2.71	1.57	0.39	2.34	2.68	2.00	0.38	2.27	2.66	2.42	0.38	2.21	2.83	2.81	0.41	2.60	

Continued:

MDVF-400D304E																							
EWT	ΔT	Indoor temp (W.B.)	Indoor temperature (D.B.)																				
			21				23				25				27				29				
			TC	SC	WF	WPD	TC	SC	WF	WPD	TC	SC	WF	WPD	TC	SC	WF	WPD	TC	SC	WF	WPD	
°C	°C	°C	kW	kW	m³/h	kPa	kW	kW	m³/h	kPa	kW	kW	m³/h	kPa	kW	kW	m³/h	kPa	kW	kW	m³/h	kPa	
11	3	15	1.44	1.44	0.41	2.67	1.87	1.87	0.53	4.51	2.30	2.30	0.66	6.40	2.72	2.72	0.78	8.53	3.14	3.14	0.89	10.88	
		17	1.53	1.44	0.43	3.08	1.88	1.88	0.53	4.53	2.31	2.31	0.66	6.42	2.73	2.73	0.78	8.56	3.14	3.14	0.90	10.91	
		19	-	-	-	-	2.89	1.89	0.82	9.44	2.86	2.31	0.81	9.25	2.83	2.73	0.81	9.12	3.15	3.15	0.90	10.95	
		20	-	-	-	-	3.62	1.90	1.04	14.03	3.58	2.32	1.02	13.61	3.54	2.74	1.01	13.38	3.50	3.16	1.00	13.14	
	4	15	1.23	1.23	0.26	0.86	1.63	1.63	0.35	1.77	2.05	2.05	0.44	3.15	2.48	2.48	0.53	4.44	2.90	2.90	0.62	5.79	
		17	1.23	1.22	0.26	0.86	1.63	1.63	0.35	1.78	2.05	2.05	0.44	3.16	2.48	2.48	0.53	4.45	2.90	2.90	0.62	5.81	
		19	-	-	-	-	2.18	1.63	0.47	3.58	2.16	2.06	0.46	3.51	2.49	2.49	0.53	4.47	2.91	2.91	0.62	5.83	
		20	-	-	-	-	2.94	1.65	0.63	5.92	2.90	2.07	0.62	5.81	2.87	2.49	0.61	5.69	2.90	2.87	0.62	5.79	
	5	15	1.02	1.02	0.18	0.53	1.43	1.43	0.25	0.76	1.83	1.83	0.32	1.36	2.23	2.23	0.38	2.31	2.65	2.65	0.46	3.41	
		17	1.02	1.02	0.18	0.53	1.44	1.44	0.25	0.77	1.83	1.83	0.32	1.36	2.24	2.24	0.38	2.32	2.65	2.65	0.46	3.42	
		19	-	-	-	-	1.61	1.43	0.28	0.97	1.84	1.83	0.32	1.37	2.24	2.24	0.39	2.34	2.66	2.66	0.46	3.44	
		20	-	-	-	-	2.21	1.39	0.38	2.26	2.18	1.82	0.38	2.18	2.22	2.19	0.38	2.29	2.67	2.67	0.46	3.44	
	6	15	0.81	0.81	0.12	0.34	1.22	1.22	0.17	0.52	1.63	1.63	0.23	0.70	2.03	2.03	0.29	1.10	2.42	2.42	0.35	1.79	
		17	0.81	0.81	0.12	0.34	1.22	1.22	0.18	0.52	1.63	1.63	0.23	0.70	2.03	2.03	0.29	1.11	2.42	2.42	0.35	1.79	
		19	-	-	-	-	1.22	1.20	0.17	0.52	1.63	1.63	0.23	0.70	2.03	2.03	0.29	1.12	2.43	2.43	0.35	1.80	
		20	-	-	-	-	1.65	1.20	0.24	0.72	1.68	1.64	0.24	0.73	2.04	2.04	0.29	1.12	2.43	2.43	0.35	1.81	
	13	3	15	1.03	1.03	0.30	1.15	1.44	1.44	0.41	2.81	1.88	1.88	0.54	4.52	2.30	2.30	0.66	6.39	2.72	2.72	0.78	8.50
			17	1.03	1.03	0.30	1.16	1.45	1.45	0.42	2.82	1.88	1.88	0.54	4.53	2.31	2.31	0.66	6.41	2.73	2.73	0.78	8.52
			19	-	-	-	-	1.68	1.45	0.48	3.75	1.88	1.85	0.54	4.52	2.31	2.31	0.66	6.43	2.73	2.73	0.78	8.55
			20	-	-	-	-	2.42	1.46	0.70	6.96	2.39	1.89	0.69	6.80	2.38	2.32	0.68	6.75	2.73	2.73	0.79	8.57
		4	15	0.82	0.82	0.18	0.51	1.23	1.23	0.27	0.88	1.63	1.63	0.35	1.87	2.05	2.05	0.44	3.20	2.48	2.48	0.53	4.42
			17	0.82	0.82	0.18	0.51	1.23	1.23	0.27	0.88	1.63	1.63	0.35	1.88	2.06	2.06	0.44	3.21	2.48	2.48	0.53	4.43
			19	-	-	-	-	1.22	1.19	0.26	0.87	1.64	1.64	0.35	1.89	2.06	2.06	0.44	3.23	2.49	2.49	0.54	4.45
			20	-	-	-	-	1.67	1.21	0.36	1.98	1.67	1.64	0.36	1.99	2.06	2.06	0.44	3.23	2.49	2.49	0.54	4.46
5		15	0.61	0.61	0.10	0.30	1.02	1.02	0.17	0.50	1.43	1.43	0.25	0.75	1.82	1.82	0.31	1.38	2.23	2.23	0.38	2.35	
		17	0.61	0.61	0.10	0.30	1.02	1.02	0.17	0.50	1.43	1.43	0.25	0.75	1.83	1.83	0.31	1.39	2.23	2.23	0.38	2.36	
		19	-	-	-	-	1.02	1.02	0.18	0.50	1.43	1.43	0.25	0.75	1.83	1.83	0.31	1.40	2.24	2.24	0.38	2.37	
		20	-	-	-	-	1.11	1.02	0.19	0.54	1.43	1.43	0.25	0.75	1.83	1.83	0.31	1.40	2.24	2.24	0.38	2.38	
6		15	0.40	0.40	0.06	0.16	0.81	0.81	0.12	0.32	1.22	1.22	0.17	0.49	1.63	1.63	0.23	0.68	2.02	2.02	0.29	1.13	
		17	0.40	0.40	0.06	0.16	0.81	0.81	0.12	0.32	1.22	1.22	0.17	0.49	1.63	1.63	0.23	0.68	2.02	2.02	0.29	1.13	
		19	-	-	-	-	0.81	0.81	0.12	0.33	1.22	1.22	0.18	0.49	1.63	1.63	0.23	0.68	2.03	2.03	0.29	1.14	
		20	-	-	-	-	0.81	0.79	0.12	0.32	1.23	1.23	0.18	0.49	1.64	1.64	0.23	0.69	2.03	2.03	0.29	1.14	
15		3	15	0.61	0.61	0.18	0.49	1.02	1.02	0.29	1.16	1.44	1.44	0.41	2.78	1.87	1.87	0.53	4.38	2.30	2.30	0.66	6.19
			17	0.62	0.62	0.18	0.49	1.03	1.03	0.29	1.17	1.44	1.44	0.41	2.79	1.88	1.88	0.54	4.39	2.30	2.30	0.66	6.21
			19	-	-	-	-	1.03	1.03	0.29	1.17	1.45	1.45	0.41	2.80	1.88	1.88	0.54	4.41	2.31	2.31	0.66	6.23
			20	-	-	-	-	1.12	1.02	0.32	1.47	1.45	1.45	0.41	2.81	1.88	1.88	0.54	4.42	2.31	2.31	0.66	6.25
		4	15	0.41	0.41	0.09	0.24	0.82	0.82	0.18	0.48	1.23	1.23	0.26	0.89	1.63	1.63	0.35	1.90	2.05	2.05	0.44	3.14
			17	0.41	0.41	0.09	0.24	0.82	0.82	0.18	0.48	1.23	1.23	0.26	0.89	1.63	1.63	0.35	1.91	2.06	2.06	0.44	3.15
			19	-	-	-	-	0.82	0.82	0.18	0.49	1.23	1.23	0.26	0.89	1.63	1.63	0.35	1.92	2.06	2.06	0.44	3.16
			20	-	-	-	-	0.82	0.80	0.18	0.48	1.23	1.23	0.26	0.90	1.64	1.64	0.35	1.93	2.06	2.06	0.44	3.16
	5	15	0.20	0.20	0.03	0.09	0.61	0.61	0.11	0.29	1.02	1.02	0.18	0.48	1.43	1.43	0.25	0.76	1.82	1.82	0.31	1.46	
		17	0.20	0.20	0.03	0.09	0.61	0.61	0.11	0.29	1.03	1.03	0.18	0.48	1.43	1.43	0.25	0.76	1.83	1.83	0.31	1.46	
		19	-	-	-	-	0.61	0.61	0.11	0.29	1.03	1.03	0.18	0.48	1.44	1.44	0.25	0.77	1.83	1.83	0.32	1.47	
		20	-	-	-	-	0.61	0.61	0.11	0.29	1.03	1.03	0.18	0.48	1.44	1.44	0.25	0.77	1.83	1.83	0.32	1.47	
	6	15	-	-	-	-	0.41	0.41	0.06	0.15	0.81	0.81	0.12	0.31	1.22	1.22	0.18	0.47	1.63	1.63	0.23	0.68	
		17	-	-	-	-	0.41	0.41	0.06	0.15	0.82	0.82	0.12	0.31	1.23	1.23	0.18	0.47	1.63	1.63	0.23	0.68	
		19	-	-	-	-	0.41	0.41	0.06	0.15	0.82	0.82	0.12	0.31	1.23	1.23	0.18	0.47	1.64	1.64	0.23	0.69	
		20	-	-	-	-	0.41	0.41	0.06	0.16	0.82	0.82	0.12	0.31	1.23	1.23	0.18	0.47	1.64	1.64	0.24	0.69	

Cooling capacity

MDVF-500D304E																						
EWT	ΔT	Indoor temp (W.B.)	Indoor temperature (D.B.)																			
			21				23				25				27				29			
			TC	SC	WF	WPD	TC	SC	WF	WPD	TC	SC	WF	WPD	TC	SC	WF	WPD	TC	SC	WF	WPD
°C	°C	°C	kW	kW	m³/h	kPa	kW	kW	m³/h	kPa	kW	kW	m³/h	kPa	kW	kW	m³/h	kPa	kW	kW	m³/h	kPa
5	3	15	4.03	3.23	1.15	17.61	3.99	3.72	1.14	17.30	4.22	4.22	1.21	19.24	4.70	4.70	1.35	23.22	5.18	5.18	1.48	27.12
		17	5.50	3.23	1.57	30.10	5.46	3.73	1.56	29.74	5.42	4.22	1.55	29.39	5.38	4.71	1.54	29.00	5.34	5.18	1.53	28.56
		19	-	-	-	-	7.05	3.75	2.03	46.95	7.00	4.24	2.01	46.06	6.95	4.72	2.00	45.55	6.90	5.20	1.97	44.69
		20	-	-	-	-	7.87	3.74	2.25	56.21	7.82	4.24	2.24	55.60	7.77	4.72	2.22	54.98	7.72	5.21	2.21	54.39
	4	15	3.38	2.93	0.73	7.98	3.41	3.39	0.74	8.14	3.92	3.92	0.84	10.19	4.41	4.41	0.94	12.47	4.89	4.89	1.05	14.90
		17	4.85	2.94	1.04	14.70	4.82	3.44	1.03	14.52	4.78	3.93	1.02	14.33	4.74	4.42	1.02	14.10	4.90	4.90	1.05	14.94
		19	-	-	-	-	6.39	3.45	1.37	23.60	6.35	3.94	1.36	23.33	6.31	4.43	1.35	23.07	6.26	4.91	1.34	22.80
		20	-	-	-	-	7.22	3.45	1.55	29.19	7.18	3.95	1.54	28.87	7.13	4.44	1.53	28.54	7.09	4.92	1.52	28.23
	5	15	2.66	2.62	0.46	3.28	3.12	3.12	0.54	4.70	3.62	3.62	0.62	6.07	4.12	4.12	0.71	7.55	4.60	4.60	0.79	9.13
		17	4.17	2.64	0.71	7.71	4.14	3.14	0.71	7.61	4.09	3.63	0.70	7.47	4.11	4.09	0.70	7.53	4.61	4.61	0.79	9.16
		19	-	-	-	-	5.73	3.16	0.98	13.27	5.69	3.65	0.98	13.11	5.65	4.14	0.97	12.96	5.61	4.63	0.96	12.80
		20	-	-	-	-	6.58	3.17	1.13	16.95	6.54	3.67	1.13	16.76	6.49	4.16	1.12	16.57	6.45	4.64	1.11	16.38
6	15	2.38	2.37	0.34	1.49	2.84	2.84	0.41	2.42	3.32	3.32	0.47	3.63	3.82	3.82	0.55	4.85	4.31	4.31	0.62	5.99	
	17	3.42	2.33	0.49	3.90	3.39	2.83	0.48	3.80	3.37	3.33	0.48	3.75	3.83	3.83	0.55	4.87	4.32	4.32	0.62	6.01	
	19	-	-	-	-	5.04	2.87	0.72	7.78	5.00	3.36	0.72	7.69	4.96	3.85	0.71	7.59	4.91	4.34	0.70	7.47	
	20	-	-	-	-	5.88	2.88	0.84	10.14	5.84	3.37	0.84	10.02	5.80	3.87	0.83	9.90	5.76	4.35	0.83	9.78	
7	3	15	2.89	2.72	0.83	9.87	3.22	3.22	0.92	11.86	3.72	3.72	1.07	15.38	4.21	4.21	1.22	19.01	4.69	4.69	1.34	22.59
		17	4.39	2.74	1.27	20.42	4.36	3.24	1.26	20.16	4.32	3.73	1.25	19.84	4.29	4.22	1.24	19.61	4.69	4.69	1.35	22.67
		19	-	-	-	-	5.93	3.24	1.71	34.40	5.89	3.74	1.70	34.00	5.85	4.23	1.69	33.60	5.81	4.71	1.68	33.21
		20	-	-	-	-	6.75	3.24	1.94	42.57	6.70	3.74	1.92	42.09	6.66	4.23	1.91	41.61	6.61	4.71	1.90	41.14
	4	15	2.42	2.42	0.52	4.43	2.93	2.93	0.63	6.17	3.43	3.43	0.74	8.06	3.92	3.92	0.85	10.13	4.41	4.41	0.95	12.44
		17	3.70	2.44	0.80	9.15	3.66	2.94	0.79	9.00	3.62	3.44	0.78	8.85	3.93	3.93	0.85	10.17	4.42	4.42	0.95	12.48
		19	-	-	-	-	5.24	2.95	1.13	16.56	5.21	3.45	1.13	16.59	5.18	3.94	1.12	16.39	5.13	4.43	1.11	16.14
		20	-	-	-	-	6.07	2.96	1.31	21.39	6.03	3.45	1.30	21.14	5.99	3.94	1.29	20.89	5.95	4.43	1.28	20.65
	5	15	2.14	2.14	0.37	1.93	2.63	2.63	0.45	3.27	3.13	3.13	0.54	4.68	3.63	3.63	0.62	6.02	4.12	4.12	0.71	7.47
		17	2.93	2.13	0.50	4.15	2.89	2.63	0.50	4.05	3.14	3.13	0.54	4.69	3.64	3.64	0.63	6.04	4.13	4.13	0.71	7.49
		19	-	-	-	-	4.53	2.66	0.78	8.78	4.50	3.16	0.77	8.67	4.49	3.55	0.81	20.00	4.42	4.14	0.76	8.40
		20	-	-	-	-	5.37	2.67	0.92	11.74	5.33	3.17	0.92	11.60	5.30	3.66	0.91	11.46	5.26	4.15	0.90	11.31
6	15	1.91	1.91	0.27	0.95	2.38	2.38	0.34	1.58	2.85	2.85	0.41	2.57	3.34	3.34	0.48	3.76	3.83	3.83	0.55	4.81	
	17	2.29	1.88	0.33	1.43	2.38	2.36	0.34	1.58	2.85	2.85	0.41	2.58	3.34	3.34	0.48	3.77	3.84	3.84	0.55	4.82	
	19	-	-	-	-	3.76	2.36	0.54	4.66	3.72	2.86	0.53	4.57	3.68	3.35	0.53	4.49	3.83	3.80	0.55	4.82	
	20	-	-	-	-	4.63	2.38	0.66	6.63	4.59	2.88	0.66	6.55	4.55	3.37	0.65	6.45	4.51	3.86	0.65	6.34	
9	3	15	2.22	2.22	0.64	6.18	2.72	2.72	0.78	8.77	3.22	3.22	0.92	11.68	3.71	3.71	1.07	14.94	4.20	4.20	1.20	18.41
		17	3.17	2.23	0.91	11.36	3.13	2.73	0.90	11.13	3.21	3.18	0.92	11.61	3.72	3.72	1.07	14.99	4.20	4.20	1.21	18.46
		19	-	-	-	-	4.72	2.74	1.35	22.55	4.68	3.23	1.35	22.27	4.65	3.73	1.33	21.95	4.60	4.21	1.32	21.57
		20	-	-	-	-	5.56	2.75	1.61	30.40	5.53	3.24	1.60	30.04	5.49	3.74	1.59	29.67	5.45	4.22	1.58	29.32
	4	15	1.92	1.92	0.42	2.71	2.43	2.43	0.53	4.44	2.93	2.93	0.63	6.05	3.43	3.43	0.74	7.90	3.92	3.92	0.84	9.92
		17	2.41	1.93	0.52	4.37	2.43	2.43	0.53	4.46	2.94	2.94	0.63	6.07	3.43	3.43	0.74	7.92	3.92	3.92	0.84	9.95
		19	-	-	-	-	4.00	2.45	0.86	10.28	3.96	2.95	0.85	10.12	3.92	3.44	0.84	9.93	3.94	3.94	0.85	10.02
		20	-	-	-	-	4.84	2.46	1.04	14.24	4.80	2.96	1.04	14.12	4.77	3.45	1.03	13.99	4.73	3.94	1.02	13.85
	5	15	1.68	1.68	0.29	1.04	2.14	2.14	0.37	2.00	2.63	2.63	0.45	3.35	3.14	3.14	0.54	4.63	3.63	3.63	0.63	5.93
		17	1.76	1.67	0.30	1.16	2.15	2.15	0.37	2.01	2.64	2.64	0.45	3.37	3.14	3.14	0.54	4.64	3.64	3.64	0.63	5.95
		19	-	-	-	-	3.22	2.15	0.55	4.83	3.18	2.65	0.55	4.72	3.18	3.15	0.55	4.74	3.65	3.65	0.63	5.97
		20	-	-	-	-	4.08	2.17	0.70	7.23	4.05	2.67	0.70	7.13	4.00	3.16	0.69	7.00	3.97	3.65	0.68	6.89
6	15	1.43	1.43	0.21	0.64	1.91	1.91	0.27	0.94	2.37	2.37	0.34	1.63	2.85	2.85	0.41	2.64	3.34	3.34	0.48	3.74	
	17	1.43	1.42	0.21	0.64	1.92	1.92	0.27	0.94	2.38	2.38	0.34	1.64	2.85	2.85	0.41	2.65	3.35	3.35	0.48	3.76	
	19	-	-	-	-	2.43	1.87	0.35	1.75	2.44	2.38	0.35	1.77	2.86	2.86	0.41	2.67	3.35	3.35	0.48	3.77	
	20	-	-	-	-	3.25	1.86	0.47	3.56	3.21	2.36	0.46	3.46	3.17	2.86	0.45	3.39	3.35	3.31	0.48	3.75	

Continued:

MDVF-500D304E																						
EWT	ΔT	Indoor temp (W.B.)	Indoor temperature (D.B.)																			
			21				23				25				27				29			
			TC	SC	WF	WPD	TC	SC	WF	WPD	TC	SC	WF	WPD	TC	SC	WF	WPD	TC	SC	WF	WPD
°C	°C	°C	kW	kW	m³/h	kPa	kW	kW	m³/h	kPa	kW	kW	m³/h	kPa	kW	kW	m³/h	kPa	kW	kW	m³/h	kPa
11	3	15	1.71	1.71	0.49	3.85	2.22	2.22	0.63	6.01	2.72	2.72	0.78	8.51	3.21	3.21	0.92	11.33	3.71	3.71	1.06	14.57
		17	1.84	1.71	0.52	4.38	2.22	2.22	0.63	6.03	2.73	2.73	0.78	8.54	3.22	3.22	0.92	11.37	3.71	3.71	1.06	14.61
		19	-	-	-	-	3.43	2.23	0.98	12.65	3.39	2.73	0.97	12.39	3.36	3.23	0.96	12.25	3.72	3.72	1.06	14.66
		20	-	-	-	-	4.26	2.24	1.22	18.44	4.23	2.74	1.21	18.20	4.19	3.23	1.20	17.89	4.15	3.72	1.18	17.57
	4	15	1.44	1.44	0.31	1.26	1.92	1.92	0.41	2.72	2.43	2.43	0.52	4.30	2.93	2.93	0.63	5.91	3.43	3.43	0.73	7.70
		17	1.44	1.43	0.31	1.26	1.92	1.92	0.41	2.73	2.44	2.44	0.52	4.32	2.94	2.94	0.63	5.93	3.43	3.43	0.73	7.73
		19	-	-	-	-	2.63	1.94	0.56	4.91	2.61	2.44	0.56	4.84	2.94	2.94	0.63	5.95	3.44	3.44	0.74	7.75
		20	-	-	-	-	3.50	1.95	0.75	7.97	3.46	2.45	0.74	7.82	3.42	2.95	0.73	7.67	3.45	3.45	0.74	7.81
	5	15	1.20	1.20	0.21	0.62	1.68	1.68	0.29	1.08	2.15	2.15	0.37	2.09	2.64	2.64	0.46	3.39	3.15	3.15	0.54	4.58
		17	1.21	1.21	0.21	0.62	1.68	1.68	0.29	1.08	2.15	2.15	0.37	2.10	2.65	2.65	0.46	3.41	3.15	3.15	0.54	4.59
		19	-	-	-	-	1.87	1.67	0.32	1.43	2.15	2.14	0.37	2.11	2.66	2.66	0.46	3.42	3.16	3.16	0.54	4.61
		20	-	-	-	-	2.65	1.65	0.46	3.41	2.61	2.16	0.45	3.32	2.66	2.66	0.46	3.43	3.16	3.16	0.54	4.62
6	15	0.95	0.95	0.14	0.40	1.44	1.44	0.21	0.61	1.91	1.91	0.27	0.95	2.37	2.37	0.34	1.70	2.85	2.85	0.41	2.72	
	17	0.96	0.96	0.14	0.41	1.44	1.44	0.21	0.61	1.92	1.92	0.28	0.96	2.38	2.38	0.34	1.71	2.86	2.86	0.41	2.73	
	19	-	-	-	-	1.45	1.44	0.21	0.61	1.92	1.92	0.28	0.96	2.38	2.38	0.34	1.72	2.87	2.87	0.41	2.75	
	20	-	-	-	-	1.94	1.41	0.28	0.98	1.98	1.92	0.28	1.04	2.38	2.38	0.34	1.72	2.87	2.87	0.41	2.75	
13	3	15	1.21	1.21	0.35	1.78	1.71	1.71	0.49	3.87	2.22	2.22	0.64	6.01	2.72	2.72	0.78	8.49	3.21	3.21	0.92	11.30
		17	1.21	1.21	0.35	1.79	1.72	1.72	0.49	3.89	2.23	2.23	0.64	6.03	2.73	2.73	0.78	8.52	3.22	3.22	0.92	11.33
		19	-	-	-	-	2.02	1.72	0.58	5.11	2.22	2.19	0.64	6.00	2.73	2.73	0.78	8.55	3.22	3.22	0.93	11.37
		20	-	-	-	-	2.88	1.73	0.83	9.35	2.84	2.24	0.82	9.13	2.83	2.74	0.81	9.10	3.23	3.23	0.93	11.39
	4	15	0.97	0.97	0.21	0.60	1.44	1.44	0.31	1.33	1.93	1.93	0.42	2.82	2.44	2.44	0.52	4.29	2.93	2.93	0.63	5.81
		17	0.97	0.97	0.21	0.61	1.44	1.44	0.31	1.34	1.93	1.93	0.42	2.84	2.44	2.44	0.53	4.31	2.93	2.93	0.63	5.83
		19	-	-	-	-	1.44	1.40	0.31	1.32	1.94	1.94	0.42	2.85	2.45	2.45	0.53	4.32	2.94	2.94	0.63	5.85
		20	-	-	-	-	2.00	1.43	0.43	3.03	2.00	1.94	0.43	3.06	2.45	2.45	0.53	4.33	2.94	2.94	0.63	5.86
	5	15	0.72	0.72	0.12	0.35	1.20	1.20	0.21	0.59	1.67	1.67	0.29	1.10	2.14	2.14	0.37	2.13	2.65	2.65	0.45	3.34
		17	0.72	0.72	0.12	0.35	1.20	1.20	0.21	0.59	1.68	1.68	0.29	1.10	2.15	2.15	0.37	2.14	2.65	2.65	0.45	3.35
		19	-	-	-	-	1.21	1.21	0.21	0.59	1.68	1.68	0.29	1.11	2.15	2.15	0.37	2.15	2.66	2.66	0.46	3.36
		20	-	-	-	-	1.32	1.20	0.23	0.65	1.68	1.67	0.29	1.11	2.16	2.16	0.37	2.16	2.66	2.66	0.46	3.37
6	15	0.48	0.48	0.07	0.19	0.96	0.96	0.14	0.38	1.44	1.44	0.21	0.58	1.91	1.91	0.27	0.97	2.37	2.37	0.34	1.74	
	17	0.48	0.48	0.07	0.19	0.96	0.96	0.14	0.38	1.44	1.44	0.21	0.58	1.91	1.91	0.27	0.97	2.38	2.38	0.34	1.75	
	19	-	-	-	-	0.96	0.96	0.14	0.39	1.45	1.45	0.21	0.58	1.92	1.92	0.27	0.98	2.38	2.38	0.34	1.76	
	20	-	-	-	-	0.96	0.94	0.14	0.38	1.45	1.45	0.21	0.58	1.92	1.92	0.27	0.98	2.38	2.38	0.34	1.77	
15	3	15	0.73	0.73	0.21	0.58	1.20	1.20	0.34	1.79	1.71	1.71	0.49	3.76	2.22	2.22	0.63	5.83	2.71	2.71	0.77	8.24
		17	0.73	0.73	0.21	0.58	1.20	1.20	0.34	1.80	1.72	1.72	0.49	3.77	2.22	2.22	0.63	5.85	2.72	2.72	0.78	8.26
		19	-	-	-	-	1.21	1.21	0.34	1.81	1.72	1.72	0.49	3.78	2.23	2.23	0.63	5.87	2.72	2.72	0.78	8.29
		20	-	-	-	-	1.32	1.20	0.38	2.29	1.72	1.71	0.49	3.79	2.23	2.23	0.64	5.88	2.73	2.73	0.78	8.30
	4	15	0.48	0.48	0.10	0.28	0.97	0.97	0.21	0.57	1.44	1.44	0.31	1.36	1.93	1.93	0.41	2.81	2.44	2.44	0.52	4.19
		17	0.48	0.48	0.10	0.28	0.97	0.97	0.21	0.57	1.44	1.44	0.31	1.37	1.93	1.93	0.41	2.82	2.44	2.44	0.52	4.20
		19	-	-	-	-	0.97	0.97	0.21	0.57	1.44	1.44	0.31	1.37	1.94	1.94	0.42	2.83	2.44	2.44	0.52	4.22
		20	-	-	-	-	0.97	0.95	0.21	0.57	1.44	1.44	0.31	1.38	1.94	1.94	0.42	2.84	2.45	2.45	0.52	4.22
	5	15	0.24	0.24	0.04	0.11	0.72	0.72	0.12	0.34	1.21	1.21	0.21	0.57	1.68	1.68	0.29	1.15	2.15	2.15	0.37	2.23
		17	0.24	0.24	0.04	0.11	0.73	0.73	0.13	0.34	1.21	1.21	0.21	0.57	1.68	1.68	0.29	1.16	2.16	2.16	0.37	2.24
		19	-	-	-	-	0.73	0.73	0.13	0.34	1.21	1.21	0.21	0.57	1.68	1.68	0.29	1.17	2.16	2.16	0.37	2.25
		20	-	-	-	-	0.73	0.73	0.13	0.34	1.21	1.21	0.21	0.57	1.68	1.68	0.29	1.17	2.16	2.16	0.37	2.26
6	15	-	-	-	-	0.48	0.48	0.07	0.18	0.96	0.96	0.14	0.37	1.44	1.44	0.21	0.56	1.91	1.91	0.27	1.02	
	17	-	-	-	-	0.48	0.48	0.07	0.18	0.96	0.96	0.14	0.37	1.45	1.45	0.21	0.56	1.91	1.91	0.27	1.02	
	19	-	-	-	-	0.48	0.48	0.07	0.18	0.97	0.97	0.14	0.37	1.45	1.45	0.21	0.56	1.92	1.92	0.28	1.03	
	20	-	-	-	-	0.48	0.48	0.07	0.18	0.97	0.97	0.14	0.37	1.45	1.45	0.21	0.56	1.92	1.92	0.28	1.03	

Cooling capacity

MDVF-600D304E																						
EWT	ΔT	Indoor temp (W.B.)	Indoor temperature (D.B.)																			
			21				23				25				27				29			
°C	°C	°C	TC	SC	WF	WPD	TC	SC	WF	WPD	TC	SC	WF	WPD	TC	SC	WF	WPD	TC	SC	WF	WPD
5	3	15	5.42	4.26	1.55	38.12	5.37	4.89	1.54	37.53	5.51	5.49	1.58	39.21	6.14	6.14	1.77	47.87	6.74	6.74	1.93	55.68
		17	7.32	4.28	2.11	65.23	7.27	4.91	2.10	64.40	7.21	5.53	2.08	63.56	7.15	6.15	2.06	62.62	7.10	6.76	2.05	61.82
		19	-	-	-	-	9.27	4.92	2.66	97.63	9.20	5.54	2.64	96.41	9.14	6.16	2.63	95.24	9.08	6.77	2.61	94.09
		20	-	-	-	-	10.34	4.93	2.98	118.59	10.27	5.56	2.97	117.89	10.21	6.18	2.96	117.53	10.15	6.79	2.94	116.14
	4	15	4.68	3.92	1.01	18.10	4.68	4.56	1.01	18.10	5.18	5.18	1.12	21.52	5.79	5.79	1.24	25.85	6.41	6.41	1.37	30.76
		17	6.56	3.93	1.41	32.09	6.51	4.56	1.40	31.65	6.46	5.19	1.38	31.17	6.40	5.81	1.37	30.72	6.45	6.43	1.38	31.16
		19	-	-	-	-	8.54	4.58	1.83	50.65	8.47	5.21	1.82	50.02	8.41	5.83	1.81	49.41	8.35	6.44	1.79	48.77
		20	-	-	-	-	9.62	4.59	2.08	62.95	9.55	5.22	2.06	62.20	9.48	5.84	2.05	61.46	9.42	6.46	2.03	60.72
	5	15	3.90	3.57	0.67	8.90	4.21	4.20	0.72	10.15	4.84	4.84	0.83	12.89	5.47	5.47	0.94	16.00	6.08	6.08	1.05	19.20
		17	5.81	3.59	1.00	17.75	5.76	4.23	0.99	17.48	5.71	4.86	0.98	17.21	5.70	5.48	0.98	17.17	6.10	6.09	1.05	19.27
		19	-	-	-	-	7.79	4.25	1.34	29.40	7.73	4.88	1.33	29.04	7.66	5.49	1.31	28.33	7.59	6.11	1.30	27.92
		20	-	-	-	-	8.86	4.25	1.53	36.71	8.79	4.89	1.52	36.27	8.73	5.51	1.51	35.80	8.67	6.12	1.49	35.35
6	15	3.24	3.23	0.46	4.46	3.86	3.86	0.55	6.43	4.50	4.50	0.64	8.34	5.13	5.13	0.73	10.41	5.75	5.75	0.83	12.69	
	17	4.99	3.24	0.72	9.93	4.94	3.88	0.71	9.76	4.92	4.51	0.70	9.68	5.15	5.15	0.74	10.48	5.76	5.76	0.83	12.73	
	19	-	-	-	-	6.98	3.90	1.00	17.57	6.93	4.53	0.99	17.32	6.87	5.16	0.98	17.06	6.81	5.77	0.97	16.82	
	20	-	-	-	-	8.06	3.91	1.15	22.48	8.00	4.54	1.14	22.20	7.94	5.17	1.14	21.91	7.88	5.79	1.13	21.61	
7	3	15	3.97	3.60	1.14	22.03	4.24	4.23	1.22	24.65	4.88	4.88	1.41	31.80	5.50	5.50	1.59	39.15	6.10	6.10	1.75	46.43
		17	5.86	3.62	1.68	43.27	5.81	4.25	1.67	42.56	5.75	4.88	1.65	41.88	5.72	5.50	1.64	41.52	6.12	6.12	1.76	46.60
		19	-	-	-	-	7.85	4.27	2.27	73.01	7.80	4.91	2.26	72.24	7.74	5.53	2.24	71.30	7.68	6.14	2.23	70.30
		20	-	-	-	-	8.90	4.27	2.57	90.20	8.84	4.91	2.55	89.06	8.78	5.53	2.53	87.92	8.73	6.15	2.53	87.65
	4	15	3.30	3.28	0.71	9.77	3.91	3.91	0.84	13.13	4.53	4.53	0.97	16.77	5.16	5.16	1.11	20.94	5.77	5.77	1.24	25.44
		17	5.07	3.28	1.09	20.31	5.02	3.91	1.08	19.94	4.98	4.54	1.07	19.71	5.18	5.17	1.11	21.06	5.79	5.79	1.24	25.53
		19	-	-	-	-	7.05	3.93	1.52	35.94	7.00	4.56	1.51	35.53	6.95	5.19	1.50	35.42	6.89	5.81	1.49	34.88
		20	-	-	-	-	8.14	3.94	1.76	46.56	8.08	4.58	1.75	45.97	8.02	5.20	1.74	45.39	7.96	5.82	1.72	44.77
	5	15	2.92	2.92	0.50	5.34	3.56	3.56	0.61	7.56	4.20	4.20	0.72	10.00	4.83	4.83	0.83	12.68	5.45	5.45	0.94	15.65
		17	4.24	2.93	0.73	10.14	4.20	3.57	0.72	9.99	4.29	4.22	0.74	10.36	4.84	4.84	0.83	12.72	5.46	5.46	0.94	15.71
		19	-	-	-	-	6.24	3.59	1.07	19.68	6.18	4.23	1.06	19.37	6.18	4.74	1.11	30.00	6.09	5.47	1.05	18.84
		20	-	-	-	-	7.32	3.60	1.26	25.89	7.26	4.24	1.25	25.55	7.20	4.86	1.24	25.19	7.14	5.48	1.23	24.81
6	15	2.59	2.59	0.37	2.60	3.21	3.21	0.46	4.48	3.86	3.86	0.55	6.31	4.49	4.49	0.64	8.18	5.12	5.12	0.73	10.20	
	17	3.34	2.57	0.48	4.86	3.38	3.23	0.48	4.97	3.87	3.86	0.55	6.34	4.50	4.50	0.65	8.20	5.13	5.13	0.73	10.23	
	19	-	-	-	-	5.39	3.25	0.77	11.14	5.34	3.89	0.76	10.94	5.29	4.52	0.76	10.80	5.34	5.15	0.77	10.98	
	20	-	-	-	-	6.48	3.26	0.93	15.25	6.42	3.90	0.92	15.02	6.36	4.53	0.91	14.78	6.30	5.15	0.90	14.55	
9	3	15	2.95	2.95	0.85	13.06	3.59	3.59	1.03	18.28	4.23	4.23	1.21	24.19	4.86	4.86	1.41	31.17	5.47	5.47	1.57	37.82
		17	4.31	2.96	1.24	24.99	4.26	3.60	1.22	24.56	4.30	4.25	1.24	24.94	4.87	4.87	1.41	31.28	5.48	5.48	1.57	37.95
		19	-	-	-	-	6.31	3.62	1.83	49.21	6.26	4.25	1.81	48.50	6.20	4.88	1.80	47.72	6.15	5.50	1.78	47.01
		20	-	-	-	-	7.36	3.62	2.12	63.68	7.31	4.26	2.11	62.89	7.27	4.89	2.10	62.75	7.21	5.51	2.09	62.17
	4	15	2.61	2.61	0.56	6.44	3.26	3.26	0.70	9.39	3.89	3.89	0.84	12.74	4.52	4.52	0.97	16.49	5.14	5.14	1.11	20.65
		17	3.45	2.62	0.74	10.35	3.46	3.27	0.75	10.42	3.90	3.89	0.84	12.78	4.53	4.53	0.98	16.55	5.16	5.16	1.11	20.72
		19	-	-	-	-	5.47	3.28	1.18	23.07	5.41	3.92	1.17	22.52	5.36	4.54	1.16	22.18	5.37	5.17	1.16	22.26
		20	-	-	-	-	6.53	3.28	1.41	31.03	6.48	3.92	1.39	30.59	6.42	4.55	1.38	30.11	6.36	5.17	1.37	29.64
	5	15	2.27	2.27	0.39	3.03	2.91	2.91	0.50	5.29	3.56	3.56	0.61	7.42	4.19	4.19	0.72	9.81	4.82	4.82	0.83	12.43
		17	2.56	2.26	0.44	4.08	2.92	2.90	0.50	5.30	3.57	3.57	0.61	7.45	4.20	4.20	0.72	9.85	4.83	4.83	0.83	12.48
		19	-	-	-	-	4.58	2.94	0.79	11.40	4.53	3.58	0.78	11.21	4.54	4.21	0.78	11.22	4.85	4.85	0.83	12.57
		20	-	-	-	-	5.67	2.95	0.98	16.42	5.61	3.59	0.97	16.15	5.56	4.22	0.96	15.88	5.52	4.84	0.95	15.70
6	15	1.96	1.96	0.28	1.29	2.58	2.58	0.37	2.67	3.22	3.22	0.46	4.52	3.86	3.86	0.55	6.21	4.49	4.49	0.64	8.03	
	17	2.02	1.98	0.29	1.38	2.58	2.58	0.37	2.68	3.22	3.22	0.46	4.54	3.86	3.86	0.55	6.23	4.50	4.50	0.64	8.06	
	19	-	-	-	-	3.64	2.59	0.52	5.63	3.64	3.23	0.52	5.62	3.91	3.89	0.56	6.36	4.51	4.51	0.65	8.09	
	20	-	-	-	-	4.75	2.61	0.68	8.84	4.70	3.25	0.67	8.68	4.66	3.88	0.67	8.57	4.73	4.52	0.68	8.79	

Continued:

MDVF-600D304E																							
EWT	ΔT	Indoor temp (W.B.)	Indoor temperature (D.B.)																				
			21				23				25				27				29				
			TC	SC	WF	WPD	TC	SC	WF	WPD	TC	SC	WF	WPD	TC	SC	WF	WPD	TC	SC	WF	WPD	
°C	°C	°C	kW	kW	m ³ /h	kPa	kW	kW	m ³ /h	kPa	kW	kW	m ³ /h	kPa	kW	kW	m ³ /h	kPa	kW	kW	m ³ /h	kPa	
11	3	15	2.30	2.30	0.65	8.28	2.94	2.94	0.84	12.64	3.58	3.58	1.02	17.71	4.21	4.21	1.20	23.43	4.83	4.83	1.38	29.73	
		17	2.64	2.30	0.75	10.52	2.95	2.93	0.84	12.67	3.59	3.59	1.02	17.77	4.22	4.22	1.20	23.52	4.84	4.84	1.38	29.83	
		19	-	-	-	-	4.64	2.96	1.33	27.90	4.59	3.60	1.31	27.30	4.57	4.23	1.31	27.05	4.85	4.83	1.38	29.93	
		20	-	-	-	-	5.73	2.97	1.65	40.52	5.68	3.61	1.63	39.86	5.62	4.24	1.62	39.18	5.58	4.87	1.60	38.62	
	4	15	1.95	1.95	0.42	3.66	2.61	2.61	0.56	6.27	3.25	3.25	0.70	9.13	3.88	3.88	0.83	12.38	4.51	4.51	0.97	15.98	
		17	1.95	1.93	0.42	3.68	2.61	2.61	0.56	6.30	3.26	3.26	0.70	9.16	3.89	3.89	0.83	12.42	4.52	4.52	0.97	16.05	
		19	-	-	-	-	3.73	2.62	0.80	11.53	3.71	3.26	0.79	11.45	3.93	3.92	0.84	12.63	4.53	4.53	0.97	16.11	
		20	-	-	-	-	4.81	2.63	1.03	17.88	4.76	3.27	1.02	17.55	4.72	3.90	1.01	17.31	4.75	4.54	1.02	17.48	
	5	15	1.64	1.64	0.28	1.32	2.27	2.27	0.39	3.13	2.91	2.91	0.50	5.21	3.55	3.55	0.61	7.30	4.18	4.18	0.72	9.63	
		17	1.65	1.64	0.28	1.33	2.27	2.27	0.39	3.15	2.92	2.92	0.50	5.23	3.56	3.56	0.61	7.33	4.19	4.19	0.72	9.67	
		19	-	-	-	-	2.79	2.28	0.48	4.82	2.99	2.95	0.51	5.43	3.57	3.57	0.61	7.35	4.20	4.20	0.72	9.71	
		20	-	-	-	-	3.87	2.29	0.67	8.43	3.84	2.93	0.66	8.30	3.87	3.58	0.67	8.42	4.22	4.22	0.73	9.78	
	6	15	1.33	1.33	0.19	0.72	1.96	1.96	0.28	1.32	2.58	2.58	0.37	2.76	3.22	3.22	0.46	4.49	3.85	3.85	0.55	6.05	
		17	1.33	1.33	0.19	0.73	1.96	1.96	0.28	1.33	2.58	2.58	0.37	2.77	3.22	3.22	0.46	4.50	3.85	3.85	0.55	6.07	
		19	-	-	-	-	2.07	1.98	0.30	1.53	2.59	2.58	0.37	2.79	3.23	3.23	0.46	4.52	3.86	3.86	0.55	6.10	
		20	-	-	-	-	2.85	1.94	0.41	3.53	2.88	2.59	0.41	3.61	3.25	3.25	0.47	4.58	3.87	3.87	0.55	6.11	
	13	3	15	1.64	1.64	0.47	4.66	2.29	2.29	0.66	8.23	2.94	2.94	0.84	12.56	3.57	3.57	1.03	17.60	4.20	4.20	1.21	23.26
			17	1.64	1.64	0.47	4.67	2.30	2.30	0.66	8.26	2.94	2.94	0.85	12.61	3.58	3.58	1.03	17.66	4.21	4.21	1.21	23.34
			19	-	-	-	-	2.86	2.30	0.82	11.97	2.98	2.97	0.85	12.70	3.59	3.59	1.03	17.73	4.22	4.22	1.21	23.44
			20	-	-	-	-	3.93	2.31	1.13	20.74	3.89	2.95	1.12	20.37	3.89	3.59	1.12	20.35	4.22	4.20	1.21	23.47
		4	15	1.32	1.32	0.28	1.36	1.95	1.95	0.42	3.76	2.60	2.60	0.56	6.14	3.24	3.24	0.69	8.94	3.87	3.87	0.83	12.12
			17	1.32	1.32	0.28	1.36	1.95	1.95	0.42	3.77	2.60	2.60	0.56	6.17	3.24	3.24	0.70	8.97	3.88	3.88	0.83	12.17
			19	-	-	-	-	2.00	1.98	0.43	3.95	2.61	2.60	0.56	6.19	3.25	3.25	0.70	9.01	3.89	3.89	0.83	12.22
			20	-	-	-	-	2.93	1.96	0.63	7.54	2.94	2.61	0.63	7.58	3.27	3.27	0.70	9.10	3.89	3.89	0.83	12.24
5		15	1.00	1.00	0.17	0.63	1.63	1.63	0.28	1.34	2.26	2.26	0.39	3.15	2.91	2.91	0.50	5.07	3.54	3.54	0.61	7.10	
		17	1.00	1.00	0.17	0.63	1.64	1.64	0.28	1.34	2.26	2.26	0.39	3.17	2.91	2.91	0.50	5.09	3.55	3.55	0.61	7.12	
		19	-	-	-	-	1.64	1.63	0.28	1.35	2.27	2.27	0.39	3.18	2.92	2.92	0.50	5.11	3.56	3.56	0.61	7.15	
		20	-	-	-	-	1.94	1.62	0.33	2.14	2.29	2.28	0.39	3.24	2.92	2.92	0.50	5.12	3.56	3.56	0.61	7.17	
6		15	0.68	0.68	0.10	0.35	1.32	1.32	0.19	0.68	1.95	1.95	0.28	1.34	2.57	2.57	0.37	2.80	3.21	3.21	0.46	4.39	
		17	0.68	0.68	0.10	0.35	1.33	1.33	0.19	0.69	1.96	1.96	0.28	1.35	2.57	2.57	0.37	2.81	3.22	3.22	0.46	4.41	
		19	-	-	-	-	1.33	1.33	0.19	0.69	1.96	1.96	0.28	1.36	2.58	2.58	0.37	2.83	3.22	3.22	0.46	4.42	
		20	-	-	-	-	1.39	1.35	0.20	0.72	1.96	1.96	0.28	1.36	2.58	2.58	0.37	2.84	3.23	3.23	0.46	4.43	
15		3	15	0.99	0.99	0.28	1.36	1.63	1.63	0.47	4.50	2.28	2.28	0.65	7.96	2.92	2.92	0.83	12.15	3.56	3.56	1.02	17.25
			17	0.99	0.99	0.28	1.37	1.64	1.64	0.47	4.52	2.29	2.29	0.65	7.99	2.93	2.93	0.84	12.19	3.57	3.57	1.03	17.32
			19	-	-	-	-	1.64	1.64	0.47	4.54	2.29	2.29	0.65	8.02	2.94	2.94	0.84	12.24	3.57	3.57	1.03	17.39
			20	-	-	-	-	2.00	1.64	0.57	6.32	2.30	2.27	0.66	8.06	2.94	2.94	0.84	12.27	3.58	3.58	1.03	17.42
		4	15	0.67	0.67	0.14	0.51	1.31	1.31	0.28	1.37	1.95	1.95	0.42	3.70	2.59	2.59	0.56	6.05	3.23	3.23	0.69	8.78
			17	0.67	0.67	0.14	0.51	1.31	1.31	0.28	1.38	1.95	1.95	0.42	3.72	2.60	2.60	0.56	6.07	3.24	3.24	0.69	8.81
			19	-	-	-	-	1.32	1.32	0.28	1.39	1.96	1.96	0.42	3.73	2.61	2.61	0.56	6.09	3.24	3.24	0.70	8.85
			20	-	-	-	-	1.33	1.31	0.28	1.42	1.96	1.96	0.42	3.74	2.61	2.61	0.56	6.10	3.25	3.25	0.70	8.87
	5	15	0.35	0.35	0.06	0.21	1.00	1.00	0.17	0.60	1.63	1.63	0.28	1.40	2.26	2.26	0.39	3.23	2.90	2.90	0.50	5.03	
		17	0.35	0.35	0.06	0.21	1.00	1.00	0.17	0.60	1.63	1.63	0.28	1.41	2.26	2.26	0.39	3.24	2.91	2.91	0.50	5.05	
		19	-	-	-	-	1.01	1.01	0.17	0.61	1.64	1.64	0.28	1.42	2.27	2.27	0.39	3.26	2.92	2.92	0.50	5.07	
		20	-	-	-	-	1.01	1.00	0.17	0.61	1.64	1.64	0.28	1.42	2.27	2.27	0.39	3.27	2.92	2.92	0.50	5.08	
	6	15	-	-	-	-	0.68	0.68	0.10	0.33	1.32	1.32	0.19	0.65	1.95	1.95	0.28	1.40	2.57	2.57	0.37	2.87	
		17	-	-	-	-	0.68	0.68	0.10	0.33	1.33	1.33	0.19	0.65	1.95	1.95	0.28	1.40	2.57	2.57	0.37	2.89	
		19	-	-	-	-	0.68	0.68	0.10	0.33	1.33	1.33	0.19	0.66	1.95	1.95	0.28	1.41	2.58	2.58	0.37	2.90	
		20	-	-	-	-	0.68	0.68	0.10	0.34	1.33	1.33	0.19	0.66	1.96	1.96	0.28	1.42	2.58	2.58	0.37	2.91	

Cooling capacity

MDVF-800D304E																						
EWT	ΔT	Indoor temp (W.B.)	Indoor temperature (D.B.)																			
			21				23				25				27				29			
			TC	SC	WF	WPD	TC	SC	WF	WPD	TC	SC	WF	WPD	TC	SC	WF	WPD	TC	SC	WF	WPD
°C	°C	°C	kW	kW	m³/h	kPa	kW	kW	m³/h	kPa	kW	kW	m³/h	kPa	kW	kW	m³/h	kPa	kW	kW	m³/h	kPa
5	3	15	6.31	5.09	1.81	10.03	6.25	5.87	1.80	9.85	6.65	6.65	1.91	10.96	7.42	7.42	2.13	13.23	8.18	8.18	2.35	15.65
		17	8.63	5.09	2.46	16.95	8.57	5.88	2.45	16.74	8.51	6.66	2.43	16.54	8.44	7.43	2.41	16.32	8.38	8.20	2.40	16.22
		19	-	-	-	-	11.09	5.91	3.19	26.40	11.02	6.69	3.17	26.18	10.95	7.46	3.15	25.87	10.88	8.22	3.13	25.58
		20	-	-	-	-	12.40	5.91	3.55	31.78	12.32	6.69	3.52	31.42	12.24	7.47	3.50	31.06	12.16	8.23	3.48	30.70
	4	15	5.16	4.57	1.11	4.32	5.35	5.33	1.15	4.61	6.16	6.16	1.33	5.85	6.94	6.94	1.49	7.17	7.71	7.71	1.66	8.57
		17	7.57	4.61	1.63	8.31	7.51	5.40	1.62	8.20	7.46	6.19	1.61	8.09	7.38	6.96	1.59	7.95	7.72	7.72	1.66	8.60
		19	-	-	-	-	10.01	5.42	2.14	13.28	9.94	6.20	2.13	13.12	9.87	6.98	2.12	12.97	9.81	7.74	2.10	12.81
		20	-	-	-	-	11.36	5.44	2.45	16.66	11.29	6.22	2.43	16.47	11.21	7.00	2.42	16.28	11.12	7.76	2.38	15.89
	5	15	4.18	4.15	0.72	1.47	4.89	4.89	0.84	2.25	5.65	5.65	0.97	3.26	6.44	6.44	1.11	4.27	7.22	7.22	1.24	5.19
		17	6.37	4.09	1.09	4.19	6.32	4.89	1.09	4.12	6.25	5.67	1.07	4.03	6.43	6.40	1.10	4.26	7.23	7.23	1.24	5.21
		19	-	-	-	-	8.89	4.93	1.52	7.37	8.82	5.72	1.51	7.27	8.76	6.49	1.50	7.19	8.70	7.26	1.49	7.09
		20	-	-	-	-	10.23	4.95	1.75	9.36	10.16	5.73	1.74	9.25	10.09	6.51	1.73	9.14	10.02	7.28	1.72	9.04
6	15	3.76	3.76	0.54	0.81	4.51	4.51	0.64	1.12	5.24	5.24	0.75	1.67	5.97	5.97	0.85	2.38	6.72	6.72	0.96	3.20	
	17	5.31	3.65	0.76	1.74	5.27	4.46	0.75	1.70	5.25	5.25	0.75	1.69	5.98	5.98	0.85	2.39	6.74	6.74	0.96	3.22	
	19	-	-	-	-	7.68	4.43	1.10	4.19	7.62	5.22	1.09	4.13	7.56	5.99	1.08	4.07	7.48	6.76	1.07	4.00	
	20	-	-	-	-	9.06	4.46	1.30	5.57	9.00	5.25	1.29	5.51	8.93	6.03	1.28	5.44	8.87	6.80	1.27	5.37	
7	3	15	4.47	4.28	1.28	5.47	5.07	5.07	1.45	6.74	5.86	5.86	1.68	8.62	6.63	6.63	1.90	10.67	7.40	7.40	2.12	12.88
		17	6.85	4.30	1.96	11.26	6.79	5.09	1.95	11.11	6.73	5.87	1.93	10.93	6.68	6.65	1.91	10.80	7.42	7.42	2.13	12.92
		19	-	-	-	-	9.32	5.11	2.69	19.39	9.25	5.90	2.67	19.16	9.19	6.68	2.65	18.93	9.12	7.44	2.63	18.69
		20	-	-	-	-	10.62	5.11	3.05	24.03	10.55	5.90	3.03	23.74	10.48	6.68	3.00	23.46	10.40	7.45	2.98	23.18
	4	15	3.79	3.79	0.81	2.12	4.57	4.57	0.98	3.38	5.37	5.37	1.16	4.56	6.16	6.16	1.33	5.75	6.93	6.93	1.49	7.03
		17	5.68	3.81	1.22	5.02	5.62	4.60	1.21	4.93	5.56	5.39	1.20	4.83	6.17	6.17	1.33	5.77	6.95	6.95	1.50	7.06
		19	-	-	-	-	8.18	4.63	1.76	9.33	8.12	5.42	1.75	9.21	8.06	6.20	1.74	9.09	7.99	6.97	1.72	8.95
		20	-	-	-	-	9.52	4.65	2.06	12.15	9.46	5.44	2.04	12.01	9.39	6.22	2.03	11.86	9.32	6.99	2.01	11.72
	5	15	3.41	3.41	0.59	0.92	4.15	4.15	0.72	1.52	4.89	4.89	0.84	2.36	5.66	5.66	0.97	3.32	6.45	6.45	1.11	4.22
		17	4.50	3.33	0.78	1.89	4.45	4.13	0.77	1.83	4.90	4.90	0.84	2.37	5.67	5.67	0.98	3.34	6.46	6.46	1.11	4.23
		19	-	-	-	-	6.97	4.14	1.20	4.81	6.91	4.93	1.19	4.74	6.31	5.25	1.14	15.00	6.76	6.48	1.16	4.57
		20	-	-	-	-	8.32	4.16	1.43	6.50	8.26	4.95	1.42	6.42	8.20	5.73	1.41	6.34	8.13	6.51	1.40	6.25
6	15	3.00	3.00	0.43	0.61	3.77	3.77	0.54	0.79	4.51	4.51	0.65	1.17	5.23	5.23	0.75	1.76	5.98	5.98	0.86	2.50	
	17	3.59	2.98	0.52	0.74	3.74	3.67	0.54	0.78	4.51	4.51	0.65	1.18	5.24	5.24	0.75	1.77	5.99	5.99	0.86	2.51	
	19	-	-	-	-	5.72	3.65	0.82	2.23	5.66	4.45	0.81	2.18	5.60	5.23	0.80	2.11	6.00	6.00	0.86	2.53	
	20	-	-	-	-	7.04	3.66	1.01	3.58	6.99	4.45	1.00	3.53	6.92	5.24	1.00	3.47	6.85	6.01	0.98	3.40	
9	3	15	3.46	3.46	0.99	3.47	4.28	4.28	1.23	4.97	5.07	5.07	1.45	6.64	5.85	5.85	1.68	8.49	6.62	6.62	1.90	10.49
		17	4.91	3.49	1.41	6.29	4.85	4.29	1.39	6.16	5.06	5.02	1.45	6.62	5.86	5.86	1.68	8.52	6.64	6.64	1.90	10.53
		19	-	-	-	-	7.39	4.31	2.12	12.66	7.33	5.10	2.10	12.50	7.27	5.88	2.09	12.31	7.19	6.65	2.06	12.09
		20	-	-	-	-	8.72	4.32	2.51	16.96	8.66	5.11	2.49	16.75	8.60	5.89	2.48	16.54	8.53	6.67	2.46	16.33
	4	15	3.04	3.04	0.66	1.23	3.79	3.79	0.82	2.24	4.58	4.58	0.99	3.44	5.38	5.38	1.16	4.52	6.15	6.15	1.32	5.63
		17	3.65	3.00	0.79	2.03	3.76	3.68	0.81	2.20	4.59	4.59	0.99	3.45	5.39	5.39	1.17	4.54	6.16	6.16	1.33	5.65
		19	-	-	-	-	6.17	3.83	1.33	5.66	6.11	4.62	1.31	5.56	6.04	5.40	1.30	5.45	6.14	6.07	1.32	5.61
		20	-	-	-	-	7.52	3.84	1.62	7.92	7.46	4.64	1.61	7.82	7.40	5.42	1.59	7.71	7.33	6.19	1.58	7.58
	5	15	2.64	2.64	0.45	0.62	3.40	3.40	0.59	0.92	4.13	4.13	0.71	1.55	4.89	4.89	0.84	2.42	5.67	5.67	0.98	3.33
		17	2.73	2.64	0.47	0.64	3.41	3.41	0.59	0.93	4.14	4.14	0.71	1.56	4.90	4.90	0.84	2.43	5.68	5.68	0.98	3.34
		19	-	-	-	-	4.84	3.33	0.83	2.36	4.78	4.12	0.82	2.29	4.87	4.79	0.84	2.40	5.70	5.70	0.98	3.35
		20	-	-	-	-	6.23	3.35	1.07	3.92	6.17	4.15	1.06	3.86	6.10	4.93	1.05	3.78	6.03	5.71	1.04	3.70
6	15	2.24	2.24	0.32	0.43	3.00	3.00	0.43	0.58	3.77	3.77	0.54	0.78	4.49	4.49	0.64	1.20	5.22	5.22	0.75	1.81	
	17	2.24	2.24	0.32	0.43	3.01	3.01	0.43	0.58	3.77	3.77	0.54	0.78	4.50	4.50	0.65	1.21	5.23	5.23	0.75	1.82	
	19	-	-	-	-	3.87	2.98	0.55	0.82	3.86	3.78	0.55	0.82	4.51	4.51	0.65	1.22	5.24	5.24	0.75	1.83	
	20	-	-	-	-	4.97	2.89	0.71	1.58	4.91	3.70	0.70	1.54	4.86	4.49	0.70	1.49	5.25	5.25	0.75	1.84	

Continued:

MDVF-800D304E																						
EWT	ΔT	Indoor temp (W.B.)	Indoor temperature (D.B.)																			
			21				23				25				27				29			
			TC	SC	WF	WPD	TC	SC	WF	WPD	TC	SC	WF	WPD	TC	SC	WF	WPD	TC	SC	WF	WPD
°C	°C	°C	kW	kW	m³/h	kPa	kW	kW	m³/h	kPa	kW	kW	m³/h	kPa	kW	kW	m³/h	kPa	kW	kW	m³/h	kPa
11	3	15	2.66	2.66	0.76	1.88	3.47	3.47	0.99	3.39	4.27	4.27	1.22	4.83	5.06	5.06	1.44	6.44	5.84	5.84	1.66	8.23
		17	2.77	2.67	0.79	2.09	3.47	3.47	0.99	3.40	4.28	4.28	1.22	4.84	5.07	5.07	1.44	6.46	5.85	5.85	1.67	8.25
		19	-	-	-	-	5.32	3.50	1.52	7.01	5.25	4.30	1.50	6.87	5.21	5.08	1.48	6.76	5.86	5.86	1.67	8.28
		20	-	-	-	-	6.66	3.51	1.90	10.31	6.60	4.31	1.88	10.16	6.54	5.09	1.86	9.99	6.46	5.87	1.84	9.80
	4	15	2.28	2.28	0.49	0.65	3.03	3.03	0.65	1.24	3.79	3.79	0.81	2.25	4.58	4.58	0.98	3.33	5.37	5.37	1.15	4.36
		17	2.28	2.28	0.49	0.65	3.03	3.03	0.65	1.25	3.79	3.79	0.81	2.26	4.59	4.59	0.98	3.35	5.38	5.38	1.15	4.38
		19	-	-	-	-	3.95	3.00	0.84	2.48	3.91	3.80	0.84	2.43	4.60	4.60	0.99	3.36	5.39	5.39	1.15	4.39
		20	-	-	-	-	5.36	3.03	1.15	4.35	5.30	3.83	1.13	4.26	5.23	4.62	1.12	4.17	5.36	5.27	1.15	4.35
	5	15	1.88	1.88	0.32	0.42	2.65	2.65	0.46	0.59	3.40	3.40	0.59	0.95	4.14	4.14	0.71	1.62	4.90	4.90	0.84	2.48
		17	1.89	1.89	0.32	0.42	2.66	2.66	0.46	0.59	3.41	3.41	0.59	0.96	4.14	4.14	0.71	1.63	4.91	4.91	0.85	2.50
		19	-	-	-	-	2.95	2.65	0.51	0.69	3.42	3.41	0.59	0.96	4.15	4.15	0.71	1.64	4.92	4.92	0.85	2.51
		20	-	-	-	-	4.04	2.57	0.70	1.52	3.99	3.37	0.69	1.47	4.11	4.01	0.71	1.60	4.93	4.93	0.85	2.51
6	15	1.49	1.49	0.21	0.27	2.25	2.25	0.32	0.41	3.01	3.01	0.43	0.55	3.77	3.77	0.54	0.79	4.49	4.49	0.64	1.25	
	17	1.49	1.49	0.21	0.27	2.25	2.25	0.32	0.41	3.02	3.02	0.43	0.55	3.77	3.77	0.54	0.79	4.50	4.50	0.65	1.26	
	19	-	-	-	-	2.25	2.20	0.32	0.41	3.02	3.02	0.43	0.55	3.78	3.78	0.54	0.79	4.50	4.50	0.65	1.26	
	20	-	-	-	-	3.01	2.22	0.43	0.55	3.05	3.04	0.44	0.56	3.78	3.78	0.54	0.79	4.51	4.51	0.65	1.27	
13	3	15	1.92	1.92	0.55	0.82	2.67	2.67	0.77	1.99	3.48	3.48	1.00	3.40	4.28	4.28	1.23	4.82	5.06	5.06	1.45	6.42
		17	1.92	1.92	0.55	0.82	2.68	2.68	0.77	2.00	3.48	3.48	1.00	3.41	4.28	4.28	1.23	4.84	5.07	5.07	1.46	6.44
		19	-	-	-	-	3.03	2.68	0.87	2.67	3.49	3.48	1.00	3.42	4.29	4.29	1.23	4.85	5.08	5.08	1.46	6.47
		20	-	-	-	-	4.44	2.71	1.27	5.13	4.37	3.51	1.26	5.01	4.36	4.30	1.25	4.98	5.08	5.08	1.46	6.48
	4	15	1.51	1.51	0.33	0.40	2.29	2.29	0.49	0.64	3.03	3.03	0.65	1.31	3.79	3.79	0.82	2.33	4.59	4.59	0.99	3.32
		17	1.51	1.51	0.33	0.41	2.29	2.29	0.49	0.65	3.03	3.03	0.65	1.31	3.80	3.80	0.82	2.35	4.60	4.60	0.99	3.33
		19	-	-	-	-	2.27	2.20	0.49	0.64	3.04	3.04	0.65	1.32	3.81	3.81	0.82	2.36	4.61	4.61	0.99	3.35
		20	-	-	-	-	3.05	2.24	0.66	1.33	3.06	3.04	0.66	1.35	3.81	3.81	0.82	2.36	4.62	4.62	0.99	3.35
	5	15	1.11	1.11	0.19	0.23	1.88	1.88	0.32	0.39	2.65	2.65	0.45	0.56	3.39	3.39	0.58	0.97	4.13	4.13	0.71	1.65
		17	1.11	1.11	0.19	0.23	1.88	1.88	0.32	0.39	2.65	2.65	0.45	0.57	3.39	3.39	0.58	0.97	4.13	4.13	0.71	1.66
		19	-	-	-	-	1.89	1.89	0.32	0.40	2.66	2.66	0.46	0.57	3.40	3.40	0.58	0.98	4.14	4.14	0.71	1.67
		20	-	-	-	-	2.01	1.88	0.34	0.42	2.66	2.66	0.46	0.57	3.40	3.40	0.58	0.98	4.15	4.15	0.71	1.68
6	15	0.73	0.73	0.10	0.13	1.49	1.49	0.21	0.26	2.25	2.25	0.32	0.39	3.01	3.01	0.43	0.52	3.76	3.76	0.54	0.80	
	17	0.73	0.73	0.10	0.13	1.49	1.49	0.21	0.26	2.26	2.26	0.32	0.39	3.02	3.02	0.43	0.52	3.76	3.76	0.54	0.80	
	19	-	-	-	-	1.49	1.49	0.21	0.26	2.26	2.26	0.32	0.39	3.03	3.03	0.43	0.52	3.77	3.77	0.54	0.80	
	20	-	-	-	-	1.49	1.47	0.21	0.26	2.26	2.26	0.32	0.39	3.03	3.03	0.43	0.52	3.77	3.77	0.54	0.81	
15	3	15	1.13	1.13	0.32	0.39	1.90	1.90	0.54	0.82	2.66	2.66	0.76	2.00	3.47	3.47	0.99	3.30	4.26	4.26	1.22	4.67
		17	1.14	1.14	0.32	0.39	1.91	1.91	0.54	0.82	2.67	2.67	0.76	2.01	3.48	3.48	0.99	3.31	4.27	4.27	1.22	4.69
		19	-	-	-	-	1.91	1.91	0.55	0.82	2.67	2.67	0.76	2.02	3.48	3.48	0.99	3.32	4.28	4.28	1.22	4.70
		20	-	-	-	-	2.05	1.90	0.59	1.00	2.68	2.68	0.76	2.02	3.49	3.49	1.00	3.33	4.28	4.28	1.22	4.71
	4	15	0.74	0.74	0.16	0.19	1.51	1.51	0.32	0.38	2.28	2.28	0.49	0.64	3.02	3.02	0.65	1.33	3.79	3.79	0.81	2.33
		17	0.74	0.74	0.16	0.19	1.51	1.51	0.32	0.38	2.29	2.29	0.49	0.64	3.02	3.02	0.65	1.34	3.80	3.80	0.81	2.34
		19	-	-	-	-	1.52	1.52	0.33	0.38	2.29	2.29	0.49	0.64	3.03	3.03	0.65	1.35	3.81	3.81	0.82	2.35
		20	-	-	-	-	1.52	1.49	0.32	0.38	2.29	2.29	0.49	0.64	3.03	3.03	0.65	1.35	3.81	3.81	0.82	2.35
	5	15	0.37	0.37	0.06	0.07	1.12	1.12	0.19	0.22	1.89	1.89	0.33	0.38	2.66	2.66	0.46	0.56	3.39	3.39	0.58	1.02
		17	0.37	0.37	0.06	0.07	1.13	1.13	0.19	0.23	1.89	1.89	0.33	0.38	2.66	2.66	0.46	0.56	3.39	3.39	0.58	1.02
		19	-	-	-	-	1.13	1.13	0.19	0.23	1.90	1.90	0.33	0.38	2.67	2.67	0.46	0.56	3.40	3.40	0.59	1.03
		20	-	-	-	-	1.13	1.13	0.19	0.23	1.90	1.90	0.33	0.38	2.67	2.67	0.46	0.56	3.40	3.40	0.59	1.03
6	15	-	-	-	-	0.74	0.74	0.11	0.12	1.50	1.50	0.22	0.25	2.26	2.26	0.32	0.37	3.02	3.02	0.43	0.51	
	17	-	-	-	-	0.74	0.74	0.11	0.12	1.50	1.50	0.22	0.25	2.26	2.26	0.32	0.37	3.02	3.02	0.43	0.51	
	19	-	-	-	-	0.74	0.74	0.11	0.12	1.50	1.50	0.22	0.25	2.27	2.27	0.33	0.37	3.03	3.03	0.44	0.51	
	20	-	-	-	-	0.74	0.74	0.11	0.12	1.51	1.51	0.22	0.25	2.27	2.27	0.33	0.37	3.03	3.03	0.44	0.51	

Cooling capacity

MDVF-1000D304E																						
EWT	ΔT	Indoor temp (W.B.)	Indoor temperature (D.B.)																			
			21				23				25				27				29			
			TC	SC	WF	WPD	TC	SC	WF	WPD	TC	SC	WF	WPD	TC	SC	WF	WPD	TC	SC	WF	WPD
°C	°C	°C	kW	kW	m³/h	kPa	kW	kW	m³/h	kPa	kW	kW	m³/h	kPa	kW	kW	m³/h	kPa	kW	kW	m³/h	kPa
5	3	15	7.19	5.84	2.07	13.62	7.12	6.75	2.05	13.37	7.66	7.66	2.20	15.18	8.55	8.55	2.44	18.12	9.45	9.45	2.72	21.81
		17	9.90	5.85	2.85	23.61	9.83	6.77	2.83	23.35	9.77	7.68	2.81	23.09	9.70	8.58	2.79	22.82	9.62	9.47	2.77	22.47
		19	-	-	-	-	12.71	6.77	3.64	36.04	12.64	7.69	3.61	35.66	12.56	8.59	3.59	35.29	12.48	9.48	3.57	34.92
		20	-	-	-	-	14.25	6.78	4.08	43.95	14.16	7.69	4.05	43.50	14.08	8.60	4.03	43.06	14.00	9.49	4.00	42.62
	4	15	5.82	5.23	1.25	5.78	6.16	6.15	1.33	6.35	7.08	7.08	1.52	8.06	7.98	7.98	1.71	9.80	8.88	8.88	1.90	11.74
		17	8.58	5.26	1.84	11.07	8.52	6.18	1.83	10.94	8.46	7.09	1.81	10.81	8.37	7.99	1.79	10.62	8.89	8.89	1.91	11.77
		19	-	-	-	-	11.46	6.21	2.47	18.37	11.39	7.12	2.45	18.17	11.32	8.03	2.44	17.98	11.25	8.93	2.42	17.79
		20	-	-	-	-	12.96	6.20	2.78	22.52	12.90	7.12	2.77	22.41	12.83	8.04	2.77	22.34	12.76	8.94	2.75	22.11
	5	15	4.64	4.59	0.80	2.11	5.54	5.54	0.95	3.37	6.47	6.47	1.11	4.67	7.39	7.39	1.27	5.85	8.30	8.30	1.42	7.13
		17	7.17	4.65	1.23	5.56	7.11	5.57	1.22	5.48	7.04	6.49	1.21	5.41	7.40	7.40	1.27	5.87	8.32	8.32	1.43	7.15
		19	-	-	-	-	10.10	5.62	1.73	9.95	10.03	6.54	1.72	9.84	9.96	7.45	1.71	9.73	9.90	8.35	1.70	9.61
		20	-	-	-	-	11.65	5.63	2.00	12.71	11.58	6.55	1.99	12.57	11.50	7.46	1.97	12.43	11.43	8.37	1.96	12.30
6	15	4.24	4.24	0.61	1.06	5.07	5.07	0.73	1.66	5.91	5.91	0.84	2.51	6.79	6.79	0.97	3.56	7.71	7.71	1.10	4.60	
	17	5.79	4.08	0.83	2.37	5.72	5.01	0.82	2.30	5.90	5.84	0.84	2.49	6.80	6.80	0.97	3.57	7.73	7.73	1.11	4.61	
	19	-	-	-	-	8.66	5.03	1.24	5.62	8.60	5.95	1.23	5.55	8.54	6.86	1.22	5.48	8.45	7.76	1.21	5.38	
	20	-	-	-	-	10.26	5.06	1.47	7.47	10.19	5.98	1.46	7.39	10.12	6.89	1.45	7.31	10.05	7.79	1.44	7.22	
7	3	15	5.05	4.90	1.45	7.29	5.83	5.83	1.67	9.29	6.75	6.75	1.93	11.94	7.67	7.67	2.21	15.04	8.56	8.56	2.47	18.19
		17	7.83	4.93	2.26	15.62	7.78	5.86	2.25	15.44	7.71	6.77	2.23	15.20	7.69	7.68	2.22	15.11	8.57	8.57	2.48	18.25
		19	-	-	-	-	10.65	5.86	3.05	26.22	10.58	6.77	3.03	25.93	10.51	7.68	3.02	25.65	10.44	8.58	3.00	25.36
		20	-	-	-	-	12.21	5.87	3.53	33.68	12.13	6.79	3.51	33.32	12.06	7.70	3.49	32.97	11.98	8.60	3.46	32.62
	4	15	4.29	4.29	0.92	3.18	5.24	5.24	1.13	4.75	6.17	6.17	1.33	6.28	7.09	7.09	1.53	7.94	7.99	7.99	1.72	9.75
		17	6.43	4.34	1.39	6.72	6.37	5.27	1.37	6.61	6.31	6.19	1.36	6.51	7.10	7.10	1.53	7.96	8.01	8.01	1.73	9.77
		19	-	-	-	-	9.33	5.30	2.02	12.75	9.27	6.22	2.00	12.61	9.20	7.13	1.99	12.46	9.13	8.03	1.97	12.28
		20	-	-	-	-	10.87	5.31	2.35	16.58	10.80	6.23	2.33	16.40	10.73	7.14	2.32	16.21	10.66	8.05	2.30	16.04
	5	15	3.84	3.84	0.66	1.33	4.68	4.68	0.81	2.26	5.57	5.57	0.96	3.48	6.50	6.50	1.12	4.65	7.42	7.42	1.28	5.82
		17	4.91	3.73	0.84	2.56	4.87	4.67	0.84	2.52	5.58	5.58	0.96	3.49	6.51	6.51	1.12	4.66	7.43	7.43	1.28	5.83
		19	-	-	-	-	7.87	4.71	1.35	6.43	7.81	5.64	1.34	6.35	7.79	6.54	1.40	18.33	7.66	7.45	1.32	6.14
		20	-	-	-	-	9.44	4.73	1.62	8.76	9.37	5.65	1.61	8.65	9.31	6.57	1.60	8.55	9.24	7.47	1.59	8.45
6	15	3.39	3.39	0.49	0.75	4.25	4.25	0.61	1.10	5.08	5.08	0.73	1.76	5.93	5.93	0.85	2.66	6.84	6.84	0.98	3.68	
	17	3.91	3.35	0.56	0.92	4.25	4.22	0.61	1.09	5.08	5.08	0.73	1.76	5.94	5.94	0.85	2.67	6.85	6.85	0.99	3.69	
	19	-	-	-	-	6.30	4.10	0.91	3.08	6.23	5.03	0.90	3.00	6.17	5.95	0.89	2.93	6.86	6.86	0.99	3.70	
	20	-	-	-	-	7.90	4.13	1.13	4.72	7.84	5.06	1.12	4.66	7.77	5.97	1.11	4.59	7.68	6.88	1.10	4.50	
9	3	15	3.97	3.97	1.14	4.77	4.91	4.91	1.41	6.84	5.84	5.84	1.67	9.18	6.75	6.75	1.94	11.77	7.65	7.65	2.20	14.63
		17	5.58	4.00	1.60	8.49	5.50	4.92	1.58	8.30	5.84	5.81	1.68	9.19	6.76	6.76	1.94	11.81	7.66	7.66	2.20	14.67
		19	-	-	-	-	8.44	4.94	2.43	17.34	8.39	5.86	2.42	17.23	8.33	6.78	2.40	17.00	8.24	7.68	2.37	16.70
		20	-	-	-	-	9.97	4.94	2.86	23.10	9.91	5.87	2.84	22.83	9.84	6.78	2.83	22.57	9.77	7.68	2.81	22.31
	4	15	3.42	3.42	0.74	1.85	4.32	4.32	0.93	3.33	5.26	5.26	1.13	4.68	6.18	6.18	1.33	6.17	7.09	7.09	1.53	7.80
		17	4.01	3.39	0.87	2.81	4.31	4.25	0.93	3.30	5.26	5.26	1.13	4.70	6.19	6.19	1.33	6.19	7.11	7.11	1.53	7.82
		19	-	-	-	-	7.00	4.37	1.51	7.62	6.94	5.30	1.49	7.50	6.86	6.21	1.47	7.35	7.09	7.04	1.53	7.80
		20	-	-	-	-	8.55	4.38	1.84	10.73	8.49	5.31	1.83	10.61	8.43	6.23	1.81	10.48	8.35	7.13	1.80	10.31
	5	15	2.98	2.98	0.51	0.78	3.83	3.83	0.66	1.37	4.68	4.68	0.81	2.35	5.60	5.60	0.96	3.53	6.53	6.53	1.12	4.61
		17	3.02	2.99	0.52	0.79	3.84	3.84	0.66	1.37	4.69	4.69	0.81	2.36	5.61	5.61	0.96	3.54	6.54	6.54	1.13	4.62
		19	-	-	-	-	5.38	3.76	0.93	3.26	5.30	4.69	0.91	3.16	5.59	5.53	0.96	3.52	6.55	6.55	1.13	4.63
		20	-	-	-	-	7.02	3.81	1.21	5.22	6.97	4.73	1.20	5.14	6.89	5.65	1.19	5.05	6.82	6.56	1.17	4.96
6	15	2.52	2.52	0.36	0.53	3.40	3.40	0.49	0.72	4.25	4.25	0.61	1.12	5.08	5.08	0.73	1.82	5.95	5.95	0.85	2.73	
	17	2.52	2.51	0.36	0.53	3.40	3.40	0.49	0.72	4.25	4.25	0.61	1.12	5.08	5.08	0.73	1.82	5.96	5.96	0.85	2.74	
	19	-	-	-	-	4.17	3.34	0.60	1.07	4.27	4.27	0.61	1.14	5.10	5.10	0.73	1.83	5.97	5.97	0.86	2.75	
	20	-	-	-	-	5.40	3.22	0.77	2.15	5.34	4.16	0.77	2.08	5.30	5.08	0.76	2.04	5.97	5.97	0.86	2.76	

Continued:

MDVF-1000D304E																						
EWT	ΔT	Indoor temp (W.B.)	Indoor temperature (D.B.)																			
			21				23				25				27				29			
			TC	SC	WF	WPD	TC	SC	WF	WPD	TC	SC	WF	WPD	TC	SC	WF	WPD	TC	SC	WF	WPD
°C	°C	°C	kW	kW	m ³ /h	kPa	kW	kW	m ³ /h	kPa	kW	kW	m ³ /h	kPa	kW	kW	m ³ /h	kPa	kW	kW	m ³ /h	kPa
11	3	15	3.03	3.03	0.86	2.81	3.98	3.98	1.13	4.66	4.92	4.92	1.40	6.67	5.83	5.83	1.66	8.93	6.74	6.74	1.92	11.44
		17	3.08	3.03	0.88	2.93	3.99	3.99	1.14	4.67	4.92	4.92	1.40	6.68	5.84	5.84	1.67	8.96	6.75	6.75	1.93	11.48
		19	-	-	-	-	6.05	4.01	1.72	9.50	5.98	4.94	1.70	9.31	5.95	5.86	1.70	9.23	6.77	6.77	1.93	11.51
		20	-	-	-	-	7.62	4.03	2.18	14.24	7.56	4.96	2.17	14.09	7.47	5.86	2.13	13.65	7.39	6.77	2.11	13.39
	4	15	2.58	2.58	0.55	0.88	3.42	3.42	0.73	1.87	4.33	4.33	0.93	3.28	5.27	5.27	1.13	4.60	6.19	6.19	1.33	6.04
		17	2.58	2.58	0.55	0.88	3.42	3.42	0.73	1.88	4.34	4.34	0.93	3.29	5.28	5.28	1.13	4.61	6.20	6.20	1.33	6.06
		19	-	-	-	-	4.41	3.42	0.94	3.39	4.40	4.35	0.94	3.38	5.29	5.29	1.13	4.62	6.21	6.21	1.33	6.07
		20	-	-	-	-	6.06	3.46	1.30	5.82	5.99	4.38	1.28	5.71	5.92	5.30	1.27	5.58	6.19	6.13	1.33	6.04
	5	15	2.12	2.12	0.36	0.51	3.00	3.00	0.52	0.77	3.84	3.84	0.66	1.43	4.71	4.71	0.81	2.45	5.63	5.63	0.97	3.53
		17	2.12	2.12	0.37	0.51	3.01	3.01	0.52	0.77	3.84	3.84	0.66	1.44	4.71	4.71	0.81	2.46	5.64	5.64	0.97	3.55
		19	-	-	-	-	3.21	2.99	0.55	0.89	3.85	3.85	0.66	1.44	4.72	4.72	0.81	2.47	5.65	5.65	0.97	3.56
		20	-	-	-	-	4.39	2.88	0.76	2.06	4.34	3.81	0.75	2.00	4.71	4.65	0.81	2.45	5.66	5.66	0.97	3.56
6	15	1.66	1.66	0.24	0.33	2.54	2.54	0.36	0.50	3.42	3.42	0.49	0.70	4.25	4.25	0.61	1.17	5.09	5.09	0.73	1.90	
	17	1.66	1.66	0.24	0.33	2.54	2.54	0.36	0.50	3.42	3.42	0.49	0.70	4.26	4.26	0.61	1.17	5.10	5.10	0.73	1.91	
	19	-	-	-	-	2.54	2.51	0.36	0.50	3.43	3.43	0.49	0.71	4.26	4.26	0.61	1.18	5.11	5.11	0.73	1.92	
	20	-	-	-	-	3.25	2.50	0.47	0.65	3.45	3.45	0.49	0.71	4.27	4.27	0.61	1.18	5.11	5.11	0.73	1.92	
13	3	15	2.16	2.16	0.62	1.22	3.05	3.05	0.88	2.94	4.00	4.00	1.15	4.68	4.93	4.93	1.42	6.68	5.84	5.84	1.68	8.93
		17	2.16	2.16	0.62	1.22	3.06	3.06	0.88	2.95	4.01	4.01	1.15	4.70	4.94	4.94	1.42	6.69	5.85	5.85	1.68	8.95
		19	-	-	-	-	3.42	3.07	0.98	3.58	4.01	4.00	1.15	4.70	4.95	4.95	1.42	6.72	5.86	5.86	1.68	8.98
		20	-	-	-	-	5.03	3.09	1.45	6.92	4.96	4.03	1.42	6.75	4.99	4.96	1.43	6.81	5.87	5.87	1.69	9.00
	4	15	1.71	1.71	0.37	0.50	2.58	2.58	0.56	0.92	3.43	3.43	0.74	1.98	4.36	4.36	0.94	3.31	5.29	5.29	1.14	4.59
		17	1.71	1.71	0.37	0.50	2.59	2.59	0.56	0.92	3.44	3.44	0.74	1.99	4.37	4.37	0.94	3.32	5.30	5.30	1.14	4.61
		19	-	-	-	-	2.58	2.54	0.56	0.92	3.44	3.44	0.74	2.00	4.38	4.38	0.94	3.33	5.31	5.31	1.14	4.62
		20	-	-	-	-	3.30	2.51	0.71	1.80	3.42	3.36	0.74	1.96	4.38	4.38	0.94	3.34	5.32	5.32	1.14	4.63
	5	15	1.24	1.24	0.21	0.28	2.12	2.12	0.36	0.48	3.00	3.00	0.51	0.77	3.83	3.83	0.66	1.47	4.71	4.71	0.81	2.48
		17	1.25	1.25	0.21	0.28	2.13	2.13	0.36	0.49	3.00	3.00	0.52	0.77	3.83	3.83	0.66	1.47	4.72	4.72	0.81	2.49
		19	-	-	-	-	2.13	2.13	0.37	0.49	3.01	3.01	0.52	0.77	3.84	3.84	0.66	1.48	4.73	4.73	0.81	2.50
		20	-	-	-	-	2.20	2.13	0.38	0.50	3.01	3.01	0.52	0.77	3.84	3.84	0.66	1.48	4.73	4.73	0.81	2.51
6	15	0.81	0.81	0.12	0.15	1.67	1.67	0.24	0.31	2.55	2.55	0.36	0.48	3.42	3.42	0.49	0.69	4.24	4.24	0.61	1.20	
	17	0.81	0.81	0.12	0.15	1.67	1.67	0.24	0.31	2.55	2.55	0.36	0.48	3.43	3.43	0.49	0.69	4.25	4.25	0.61	1.20	
	19	-	-	-	-	1.68	1.68	0.24	0.31	2.55	2.55	0.37	0.48	3.43	3.43	0.49	0.70	4.26	4.26	0.61	1.21	
	20	-	-	-	-	1.67	1.65	0.24	0.31	2.56	2.56	0.37	0.48	3.44	3.44	0.49	0.70	4.26	4.26	0.61	1.21	
15	3	15	1.28	1.28	0.37	0.48	2.15	2.15	0.61	1.23	3.06	3.06	0.87	2.89	4.00	4.00	1.14	4.55	4.92	4.92	1.40	6.49
		17	1.28	1.28	0.37	0.48	2.15	2.15	0.61	1.23	3.06	3.06	0.87	2.89	4.01	4.01	1.14	4.57	4.93	4.93	1.41	6.50
		19	-	-	-	-	2.15	2.15	0.61	1.24	3.07	3.07	0.87	2.90	4.01	4.01	1.14	4.58	4.94	4.94	1.41	6.52
		20	-	-	-	-	2.23	2.15	0.64	1.36	3.07	3.07	0.88	2.91	4.02	4.02	1.15	4.59	4.94	4.94	1.41	6.54
	4	15	0.83	0.83	0.18	0.23	1.71	1.71	0.37	0.47	2.58	2.58	0.55	0.94	3.44	3.44	0.74	2.02	4.37	4.37	0.94	3.25
		17	0.83	0.83	0.18	0.23	1.71	1.71	0.37	0.47	2.58	2.58	0.55	0.94	3.44	3.44	0.74	2.03	4.38	4.38	0.94	3.26
		19	-	-	-	-	1.72	1.72	0.37	0.47	2.58	2.58	0.55	0.94	3.45	3.45	0.74	2.04	4.39	4.39	0.94	3.27
		20	-	-	-	-	1.71	1.69	0.37	0.47	2.59	2.59	0.55	0.95	3.45	3.45	0.74	2.04	4.39	4.39	0.94	3.27
	5	15	0.40	0.40	0.07	0.09	1.26	1.26	0.22	0.28	2.14	2.14	0.37	0.47	3.01	3.01	0.52	0.80	3.84	3.84	0.66	1.55
		17	0.40	0.40	0.07	0.09	1.27	1.27	0.22	0.28	2.15	2.15	0.37	0.47	3.01	3.01	0.52	0.80	3.85	3.85	0.66	1.56
		19	-	-	-	-	1.27	1.27	0.22	0.28	2.15	2.15	0.37	0.47	3.02	3.02	0.52	0.81	3.85	3.85	0.66	1.57
		20	-	-	-	-	1.27	1.27	0.22	0.28	2.15	2.15	0.37	0.47	3.02	3.02	0.52	0.81	3.86	3.86	0.66	1.57
6	15	-	-	-	-	0.82	0.82	0.12	0.15	1.69	1.69	0.24	0.30	2.56	2.56	0.37	0.46	3.43	3.43	0.49	0.71	
	17	-	-	-	-	0.82	0.82	0.12	0.15	1.69	1.69	0.24	0.30	2.57	2.57	0.37	0.46	3.43	3.43	0.49	0.71	
	19	-	-	-	-	0.83	0.83	0.12	0.15	1.69	1.69	0.24	0.30	2.57	2.57	0.37	0.46	3.44	3.44	0.49	0.72	
	20	-	-	-	-	0.83	0.83	0.12	0.15	1.70	1.70	0.24	0.30	2.57	2.57	0.37	0.46	3.44	3.44	0.49	0.72	

Cooling capacity

MDVF-1200D304E																						
EWT	ΔT	Indoor temp (W.B.)	Indoor temperature (D.B.)																			
			21				23				25				27				29			
			TC	SC	WF	WPD	TC	SC	WF	WPD	TC	SC	WF	WPD	TC	SC	WF	WPD	TC	SC	WF	WPD
°C	°C	°C	kW	kW	m ³ /h	kPa	kW	kW	m ³ /h	kPa	kW	kW	m ³ /h	kPa	kW	kW	m ³ /h	kPa	kW	kW	m ³ /h	kPa
5	3	15	9.16	7.29	2.64	25.07	9.07	8.41	2.61	24.65	9.50	9.50	2.73	26.59	10.59	10.59	3.03	31.87	11.67	11.67	3.34	37.73
		17	12.42	7.30	3.55	42.04	12.36	8.42	3.55	41.91	12.28	9.53	3.52	41.44	12.19	10.62	3.50	40.93	12.08	11.70	3.46	40.20
		19	-	-	-	-	15.90	8.44	4.59	65.58	15.80	9.55	4.56	64.86	15.70	10.65	4.53	64.16	15.61	11.73	4.50	63.46
		20	-	-	-	-	17.74	8.44	5.09	78.54	17.63	9.55	5.06	77.72	17.55	10.66	5.06	77.74	17.45	11.75	5.04	77.26
	4	15	7.66	6.62	1.64	11.06	7.74	7.73	1.66	11.29	8.86	8.86	1.90	14.19	9.97	9.97	2.15	17.54	11.05	11.05	2.38	20.95
		17	11.02	6.66	2.37	20.84	10.94	7.78	2.36	20.60	10.86	8.89	2.34	20.34	10.77	9.98	2.32	20.02	11.06	11.04	2.38	20.99
		19	-	-	-	-	14.45	7.79	3.10	33.01	14.36	8.90	3.08	32.65	14.27	10.00	3.06	32.29	14.18	11.09	3.04	31.93
		20	-	-	-	-	16.33	7.79	3.50	40.80	16.23	8.91	3.48	40.37	16.12	10.01	3.46	39.93	16.04	11.11	3.45	39.70
	5	15	6.10	5.93	1.05	5.08	7.08	7.08	1.21	6.59	8.20	8.20	1.41	8.48	9.31	9.31	1.60	10.52	10.41	10.41	1.79	12.72
		17	9.50	5.99	1.63	10.88	9.43	7.12	1.62	10.74	9.34	8.23	1.60	10.56	9.39	9.34	1.61	10.66	10.43	10.43	1.79	12.76
		19	-	-	-	-	13.02	7.16	2.24	18.80	12.94	8.27	2.23	18.59	12.85	9.38	2.21	18.37	12.76	10.47	2.20	18.16
		20	-	-	-	-	14.86	7.15	2.55	23.45	14.77	8.27	2.53	23.18	14.67	9.38	2.52	22.93	14.58	10.47	2.50	22.68
6	15	5.35	5.33	0.76	2.32	6.41	6.41	0.92	3.77	7.54	7.54	1.08	5.36	8.67	8.67	1.24	6.82	9.78	9.78	1.40	8.36	
	17	7.89	5.32	1.13	5.81	7.80	6.44	1.12	5.69	7.77	7.56	1.11	5.65	8.68	8.68	1.24	6.84	9.79	9.79	1.40	8.39	
	19	-	-	-	-	11.47	6.51	1.64	10.98	11.39	7.62	1.63	10.85	11.31	8.73	1.62	10.71	11.21	9.82	1.60	10.54	
	20	-	-	-	-	13.38	6.53	1.92	14.32	13.29	7.65	1.91	14.16	13.20	8.76	1.89	13.99	13.11	9.85	1.88	13.83	
7	3	15	6.58	6.15	1.89	13.89	7.29	7.29	2.10	16.74	8.38	8.38	2.40	21.06	9.48	9.48	2.72	26.06	10.58	10.58	3.06	31.92
		17	9.93	6.18	2.87	28.59	9.83	7.29	2.82	27.73	9.74	8.40	2.79	27.29	9.69	9.50	2.78	27.05	10.60	10.60	3.06	32.01
		19	-	-	-	-	13.36	7.30	3.84	47.30	13.27	8.42	3.81	46.76	13.18	9.52	3.79	46.23	13.10	10.61	3.76	45.71
		20	-	-	-	-	15.23	7.31	4.38	59.53	15.14	8.43	4.35	58.91	15.05	9.54	4.34	58.52	14.96	10.63	4.32	58.08
	4	15	5.48	5.45	1.18	6.23	6.63	6.63	1.43	8.60	7.75	7.75	1.67	11.23	8.87	8.87	1.92	14.19	9.95	9.95	2.14	17.12
		17	8.41	5.53	1.82	12.97	8.33	6.66	1.80	12.76	8.26	7.77	1.79	12.57	8.88	8.87	1.92	14.22	9.96	9.96	2.14	17.17
		19	-	-	-	-	11.87	6.67	2.55	23.22	11.79	7.79	2.53	22.94	11.70	8.89	2.52	22.67	11.61	9.99	2.50	22.34
		20	-	-	-	-	13.77	6.69	2.98	30.32	13.68	7.81	2.96	29.99	13.59	8.92	2.94	29.65	13.50	10.01	2.92	29.31
	5	15	4.84	4.84	0.83	3.00	5.96	5.96	1.02	4.84	7.10	7.10	1.22	6.55	8.22	8.22	1.41	8.40	9.32	9.32	1.60	10.41
		17	6.75	4.86	1.16	6.00	6.67	5.98	1.15	5.89	7.10	7.07	1.22	6.55	8.24	8.24	1.42	8.42	9.34	9.34	1.61	10.44
		19	-	-	-	-	10.31	6.03	1.77	12.36	10.24	7.15	1.76	12.20	10.17	8.29	1.83	32.96	10.06	9.36	1.73	11.85
		20	-	-	-	-	12.20	6.05	2.10	16.56	12.12	7.17	2.09	16.36	12.04	8.28	2.07	16.17	11.95	9.38	2.06	15.97
6	15	4.33	4.33	0.62	1.39	5.36	5.36	0.77	2.48	6.44	6.44	0.93	3.94	7.57	7.57	1.08	5.32	8.69	8.69	1.24	6.73	
	17	5.16	4.24	0.74	2.24	5.39	5.38	0.78	2.52	6.46	6.46	0.93	3.96	7.58	7.58	1.09	5.34	8.70	8.70	1.25	6.75	
	19	-	-	-	-	8.64	5.37	1.24	6.67	8.55	6.50	1.23	6.55	8.47	7.61	1.21	6.45	8.74	8.73	1.25	6.79	
	20	-	-	-	-	10.57	5.40	1.51	9.39	10.49	6.53	1.50	9.27	10.41	7.64	1.49	9.15	10.31	8.74	1.48	8.99	
9	3	15	5.02	5.02	1.44	8.62	6.15	6.15	1.77	12.19	7.27	7.27	2.10	16.36	8.37	8.37	2.40	20.72	9.47	9.47	2.72	25.63
		17	7.21	5.04	2.08	16.09	7.12	6.17	2.05	15.76	7.28	7.25	2.10	16.37	8.39	8.39	2.41	20.78	9.48	9.48	2.72	25.71
		19	-	-	-	-	10.70	6.19	3.10	32.09	10.62	7.31	3.07	31.70	10.54	8.42	3.05	31.28	10.44	9.51	3.02	30.75
		20	-	-	-	-	12.57	6.20	3.64	42.54	12.49	7.32	3.62	42.05	12.37	8.42	3.56	40.83	12.29	9.51	3.53	40.34
	4	15	4.35	4.35	0.94	4.10	5.50	5.50	1.18	6.14	6.64	6.64	1.43	8.44	7.75	7.75	1.67	11.00	8.86	8.86	1.91	13.94
		17	5.50	4.37	1.18	6.14	5.58	5.52	1.20	6.29	6.65	6.65	1.43	8.47	7.76	7.76	1.67	11.04	8.87	8.87	1.92	13.96
		19	-	-	-	-	9.09	5.55	1.96	14.45	9.01	6.67	1.94	14.23	8.93	7.79	1.93	14.09	8.98	8.89	1.93	14.17
		20	-	-	-	-	10.98	5.56	2.37	20.10	10.90	6.68	2.35	19.85	10.82	7.80	2.33	19.60	10.72	8.90	2.31	19.30
	5	15	3.78	3.78	0.65	1.61	4.84	4.84	0.83	3.12	5.98	5.98	1.03	4.82	7.12	7.12	1.22	6.47	8.23	8.23	1.42	8.28
		17	3.98	3.77	0.68	1.84	4.85	4.85	0.83	3.13	5.99	5.99	1.03	4.84	7.13	7.13	1.23	6.49	8.24	8.24	1.42	8.31
		19	-	-	-	-	7.38	4.90	1.27	6.89	7.29	6.02	1.26	6.74	7.34	7.15	1.26	6.81	8.26	8.26	1.42	8.33
		20	-	-	-	-	9.31	4.92	1.60	10.22	9.23	6.05	1.59	10.08	9.14	7.16	1.57	9.90	9.06	8.27	1.56	9.76
6	15	3.26	3.26	0.47	0.83	4.32	4.32	0.62	1.42	5.36	5.36	0.77	2.55	6.46	6.46	0.93	3.97	7.59	7.59	1.09	5.27	
	17	3.27	3.26	0.47	0.83	4.33	4.33	0.62	1.43	5.37	5.37	0.77	2.56	6.47	6.47	0.93	3.98	7.61	7.61	1.09	5.29	
	19	-	-	-	-	5.54	4.23	0.79	2.78	5.58	5.37	0.80	2.83	6.48	6.48	0.93	3.99	7.62	7.62	1.09	5.31	
	20	-	-	-	-	7.51	4.26	1.08	5.18	7.42	5.39	1.06	5.07	7.34	6.51	1.05	4.98	7.66	7.65	1.10	5.36	

Continued:

MDVF-1200D304E																						
EWT	ΔT	Indoor temp (W.B.)	Indoor temperature (D.B.)																			
			21				23				25				27				29			
			TC	SC	WF	WPD	TC	SC	WF	WPD	TC	SC	WF	WPD	TC	SC	WF	WPD	TC	SC	WF	WPD
°C	°C	°C	kW	kW	m³/h	kPa	kW	kW	m³/h	kPa	kW	kW	m³/h	kPa	kW	kW	m³/h	kPa	kW	kW	m³/h	kPa
11	3	15	3.87	3.87	1.10	5.39	5.02	5.02	1.43	8.38	6.15	6.15	1.75	11.85	7.26	7.26	2.07	15.77	8.36	8.36	2.39	20.14
		17	4.24	3.88	1.21	6.28	5.03	5.02	1.43	8.40	6.16	6.16	1.76	11.89	7.27	7.27	2.07	15.82	8.37	8.37	2.39	20.20
		19	-	-	-	-	7.78	5.04	2.22	17.77	7.69	6.17	2.19	17.41	7.64	7.28	2.18	17.25	8.39	8.38	2.39	20.26
		20	-	-	-	-	9.66	5.05	2.76	25.86	9.58	6.18	2.74	25.52	9.50	7.29	2.71	25.12	9.40	8.40	2.68	24.68
	4	15	3.25	3.25	0.70	1.98	4.36	4.36	0.93	4.03	5.51	5.51	1.18	6.01	6.64	6.64	1.42	8.25	7.75	7.75	1.66	10.74
		17	3.25	3.22	0.69	1.97	4.37	4.37	0.94	4.05	5.52	5.52	1.18	6.03	6.65	6.65	1.42	8.27	7.76	7.76	1.66	10.77
		19	-	-	-	-	6.03	4.40	1.29	6.99	5.99	5.53	1.28	6.92	6.66	6.63	1.43	8.28	7.78	7.78	1.67	10.81
		20	-	-	-	-	7.96	4.42	1.70	11.25	7.88	5.55	1.69	11.05	7.79	6.67	1.67	10.84	7.90	7.80	1.69	11.10
	5	15	2.74	2.74	0.47	0.81	3.79	3.79	0.65	1.68	4.87	4.87	0.84	3.22	6.01	6.01	1.03	4.79	7.13	7.13	1.23	6.40
		17	2.75	2.75	0.47	0.81	3.80	3.80	0.65	1.69	4.88	4.88	0.84	3.24	6.02	6.02	1.04	4.80	7.15	7.15	1.23	6.42
		19	-	-	-	-	4.24	3.76	0.73	2.28	4.87	4.84	0.84	3.24	6.03	6.03	1.04	4.82	7.16	7.16	1.23	6.44
		20	-	-	-	-	6.13	3.77	1.06	4.95	6.05	4.91	1.04	4.84	6.17	6.05	1.06	5.01	7.17	7.16	1.23	6.45
6	15	2.19	2.19	0.31	0.52	3.28	3.28	0.47	0.80	4.32	4.32	0.62	1.48	5.37	5.37	0.77	2.65	6.49	6.49	0.93	3.98	
	17	2.19	2.19	0.31	0.52	3.28	3.28	0.47	0.80	4.33	4.33	0.62	1.49	5.38	5.38	0.77	2.66	6.50	6.50	0.93	3.99	
	19	-	-	-	-	3.35	3.31	0.48	0.82	4.33	4.33	0.62	1.50	5.39	5.39	0.77	2.68	6.51	6.51	0.93	4.00	
	20	-	-	-	-	4.37	3.18	0.63	1.54	4.50	4.33	0.65	1.66	5.39	5.39	0.77	2.68	6.53	6.53	0.94	4.01	
13	3	15	2.73	2.73	0.78	2.77	3.89	3.89	1.12	5.42	5.03	5.03	1.44	8.39	6.15	6.15	1.77	11.83	7.26	7.26	2.09	15.74
		17	2.73	2.73	0.78	2.78	3.90	3.90	1.12	5.43	5.04	5.04	1.45	8.41	6.16	6.16	1.77	11.87	7.27	7.27	2.09	15.79
		19	-	-	-	-	4.63	3.90	1.33	7.28	5.03	4.99	1.45	8.39	6.17	6.17	1.77	11.91	7.28	7.28	2.09	15.84
		20	-	-	-	-	6.51	3.90	1.86	12.88	6.42	5.04	1.83	12.58	6.43	6.17	1.83	12.62	7.29	7.28	2.09	15.86
	4	15	2.20	2.20	0.47	0.80	3.25	3.25	0.70	2.09	4.39	4.39	0.94	4.06	5.51	5.51	1.18	5.92	6.63	6.63	1.42	8.12
		17	2.21	2.21	0.47	0.80	3.26	3.26	0.70	2.10	4.39	4.39	0.95	4.07	5.52	5.52	1.18	5.94	6.64	6.64	1.42	8.14
		19	-	-	-	-	3.25	3.21	0.70	2.09	4.40	4.40	0.95	4.08	5.53	5.53	1.19	5.96	6.66	6.66	1.43	8.17
		20	-	-	-	-	4.63	3.26	1.00	4.44	4.66	4.41	1.00	4.49	5.53	5.51	1.19	5.96	6.66	6.66	1.43	8.18
	5	15	1.64	1.64	0.28	0.45	2.74	2.74	0.47	0.78	3.78	3.78	0.65	1.72	4.87	4.87	0.84	3.23	6.01	6.01	1.03	4.68
		17	1.64	1.64	0.28	0.45	2.74	2.74	0.47	0.78	3.78	3.78	0.65	1.73	4.88	4.88	0.84	3.25	6.02	6.02	1.03	4.70
		19	-	-	-	-	2.75	2.74	0.47	0.79	3.79	3.79	0.65	1.73	4.89	4.89	0.84	3.26	6.03	6.03	1.04	4.71
		20	-	-	-	-	3.04	2.72	0.52	0.97	3.79	3.76	0.65	1.73	4.90	4.90	0.84	3.27	6.04	6.04	1.04	4.72
6	15	1.10	1.10	0.16	0.25	2.19	2.19	0.31	0.50	3.28	3.28	0.47	0.78	4.31	4.31	0.62	1.52	5.37	5.37	0.77	2.70	
	17	1.10	1.10	0.16	0.25	2.19	2.19	0.31	0.50	3.29	3.29	0.47	0.78	4.32	4.32	0.62	1.53	5.38	5.38	0.77	2.71	
	19	-	-	-	-	2.20	2.20	0.31	0.50	3.29	3.29	0.47	0.78	4.32	4.32	0.62	1.53	5.39	5.39	0.77	2.72	
	20	-	-	-	-	2.21	2.21	0.32	0.50	3.30	3.30	0.47	0.78	4.33	4.33	0.62	1.54	5.40	5.40	0.77	2.73	
15	3	15	1.65	1.65	0.47	0.78	2.72	2.72	0.78	2.77	3.89	3.89	1.11	5.26	5.02	5.02	1.43	8.13	6.13	6.13	1.75	11.48
		17	1.66	1.66	0.47	0.78	2.73	2.73	0.78	2.79	3.89	3.89	1.11	5.28	5.03	5.03	1.43	8.16	6.14	6.14	1.75	11.51
		19	-	-	-	-	2.73	2.73	0.78	2.80	3.90	3.90	1.11	5.29	5.03	5.03	1.44	8.19	6.15	6.15	1.76	11.55
		20	-	-	-	-	3.07	2.74	0.88	3.53	3.89	3.86	1.11	5.28	5.04	5.04	1.44	8.20	6.16	6.16	1.76	11.57
	4	15	1.10	1.10	0.24	0.37	2.20	2.20	0.47	0.78	3.25	3.25	0.70	2.14	4.39	4.39	0.94	3.97	5.52	5.52	1.18	5.85
		17	1.10	1.10	0.24	0.37	2.21	2.21	0.47	0.78	3.26	3.26	0.70	2.15	4.40	4.40	0.94	3.98	5.53	5.53	1.19	5.87
		19	-	-	-	-	2.21	2.21	0.47	0.78	3.26	3.26	0.70	2.16	4.41	4.41	0.94	3.99	5.54	5.54	1.19	5.89
		20	-	-	-	-	2.20	2.17	0.47	0.78	3.27	3.27	0.70	2.16	4.41	4.41	0.95	4.00	5.55	5.55	1.19	5.90
	5	15	0.56	0.56	0.10	0.15	1.66	1.66	0.29	0.44	2.75	2.75	0.47	0.79	3.79	3.79	0.65	1.82	4.90	4.90	0.84	3.28
		17	0.56	0.56	0.10	0.15	1.66	1.66	0.29	0.44	2.76	2.76	0.48	0.79	3.79	3.79	0.65	1.82	4.91	4.91	0.85	3.29
		19	-	-	-	-	1.67	1.67	0.29	0.44	2.76	2.76	0.48	0.79	3.80	3.80	0.65	1.83	4.92	4.92	0.85	3.30
		20	-	-	-	-	1.67	1.67	0.29	0.44	2.77	2.77	0.48	0.80	3.80	3.80	0.66	1.84	4.92	4.92	0.85	3.31
6	15	-	-	-	-	1.11	1.11	0.16	0.24	2.20	2.20	0.32	0.48	3.29	3.29	0.47	0.78	4.31	4.31	0.62	1.60	
	17	-	-	-	-	1.11	1.11	0.16	0.24	2.21	2.21	0.32	0.48	3.29	3.29	0.47	0.79	4.32	4.32	0.62	1.60	
	19	-	-	-	-	1.11	1.11	0.16	0.24	2.21	2.21	0.32	0.48	3.30	3.30	0.47	0.79	4.33	4.33	0.62	1.61	
	20	-	-	-	-	1.12	1.12	0.16	0.24	2.21	2.21	0.32	0.48	3.30	3.30	0.47	0.79	4.33	4.33	0.62	1.62	

Cooling capacity

MDVF-1400D304E																						
EWT	ΔT	Indoor temp (W.B.)	Indoor temperature (D.B.)																			
			21				23				25				27				29			
			TC	SC	WF	WPD	TC	SC	WF	WPD	TC	SC	WF	WPD	TC	SC	WF	WPD	TC	SC	WF	WPD
°C	°C	°C	kW	kW	m³/h	kPa	kW	kW	m³/h	kPa	kW	kW	m³/h	kPa	kW	kW	m³/h	kPa	kW	kW	m³/h	kPa
5	3	15	10.05	7.78	2.90	217.02	9.96	8.91	2.87	213.76	10.20	10.06	2.94	222.82	11.17	11.17	3.22	261.32	12.28	12.28	3.54	308.48
		17	13.42	7.80	3.87	360.90	13.34	8.94	3.85	356.82	13.25	10.07	3.82	352.82	13.15	11.18	3.80	348.30	13.08	12.29	3.77	344.78
		19	-	-	-	-	16.96	8.96	4.89	545.40	16.86	10.10	4.86	539.54	16.76	11.22	4.84	533.79	16.66	12.33	4.81	528.05
		20	-	-	-	-	18.89	8.98	5.45	659.78	18.78	10.11	5.42	652.74	18.66	11.23	5.39	645.83	18.55	12.35	5.35	639.01
	4	15	8.83	7.22	1.91	104.55	8.91	8.37	1.93	106.30	9.52	9.51	2.05	118.32	10.62	10.62	2.29	143.62	11.74	11.74	2.55	172.72
		17	12.23	7.24	2.65	185.23	12.15	8.39	2.64	183.13	12.05	9.52	2.62	180.69	11.96	10.64	2.60	178.36	12.15	11.76	2.64	183.24
		19	-	-	-	-	15.77	8.41	3.42	289.27	15.67	9.54	3.40	286.03	15.57	10.67	3.38	282.91	15.47	11.78	3.36	279.79
		20	-	-	-	-	17.69	8.42	3.84	354.03	17.58	9.56	3.82	350.28	17.47	10.68	3.79	346.49	17.36	11.80	3.77	342.77
	5	15	7.58	6.64	1.30	53.51	8.04	7.81	1.38	59.28	8.96	8.96	1.55	72.12	10.08	10.08	1.73	87.79	11.19	11.19	1.93	105.48
		17	10.96	6.67	1.90	102.36	10.88	7.82	1.88	101.13	10.79	8.96	1.87	99.71	10.88	10.09	1.88	101.15	11.36	11.21	1.96	108.26
		19	-	-	-	-	14.52	7.85	2.52	168.02	14.43	8.99	2.50	166.07	14.33	10.11	2.48	164.18	14.24	11.23	2.47	162.24
		20	-	-	-	-	16.44	7.86	2.85	208.64	16.33	9.00	2.83	206.31	16.23	10.13	2.81	204.03	16.13	11.24	2.80	201.80
6	15	6.60	6.09	0.95	30.79	7.31	7.25	1.05	36.50	8.41	8.41	1.21	46.74	9.52	9.52	1.36	57.64	10.65	10.65	1.53	70.26	
	17	9.59	6.08	1.37	58.29	9.50	7.23	1.36	57.35	9.55	8.38	1.37	57.83	9.97	9.54	1.43	62.76	10.70	10.67	1.54	70.80	
	19	-	-	-	-	13.19	7.27	1.89	101.59	13.10	8.41	1.88	100.39	13.00	9.54	1.87	99.07	12.93	10.67	1.86	98.46	
	20	-	-	-	-	15.14	7.30	2.18	129.93	15.03	8.43	2.16	127.74	14.93	9.56	2.14	126.25	14.83	10.68	2.13	124.74	
7	3	15	7.48	6.61	2.17	129.17	7.86	7.77	2.28	140.98	8.91	8.91	2.60	176.82	10.03	10.03	2.93	217.57	11.14	11.14	3.25	261.60
		17	10.86	6.63	3.17	250.01	10.79	7.78	3.15	247.04	10.69	8.91	3.12	243.22	10.68	10.04	3.12	242.69	11.18	11.16	3.26	263.44
		19	-	-	-	-	14.41	7.80	4.21	411.45	14.32	8.94	4.18	406.73	14.23	10.06	4.15	402.20	14.13	11.18	4.12	397.56
		20	-	-	-	-	16.33	7.81	4.77	513.38	16.23	8.95	4.74	507.62	16.13	10.08	4.71	501.95	16.03	11.20	4.68	496.42
	4	15	6.42	6.05	1.38	58.81	7.22	7.22	1.56	72.56	8.36	8.36	1.82	94.09	9.49	9.49	2.06	117.61	10.59	10.59	2.30	141.53
		17	9.57	6.07	2.08	119.31	9.48	7.22	2.06	117.34	9.44	8.36	2.05	116.49	9.76	9.50	2.11	122.39	10.61	10.61	2.30	141.95
		19	-	-	-	-	13.11	7.24	2.84	205.47	13.02	8.38	2.82	202.96	12.93	9.50	2.80	200.53	12.82	10.62	2.78	197.51
		20	-	-	-	-	15.04	7.25	3.26	261.28	14.94	8.39	3.24	258.40	14.84	9.52	3.22	255.33	14.74	10.64	3.19	252.40
	5	15	5.62	5.50	0.97	31.83	6.67	6.66	1.15	42.66	7.80	7.80	1.34	55.54	8.94	8.94	1.55	71.05	10.06	10.06	1.74	87.28
		17	8.18	5.49	1.42	60.75	8.10	6.63	1.40	59.25	8.37	7.80	1.44	62.84	9.04	8.96	1.57	72.39	10.08	10.08	1.75	87.54
		19	-	-	-	-	11.79	6.68	2.05	115.23	11.70	7.82	2.03	113.72	11.70	8.94	2.11	35.00	11.55	10.08	2.00	111.17
		20	-	-	-	-	13.69	6.68	2.37	148.87	13.60	7.83	2.35	147.11	13.54	8.97	2.35	146.97	13.41	10.08	2.32	143.48
6	15	4.93	4.92	0.71	18.41	6.10	6.10	0.88	26.56	7.24	7.24	1.04	35.48	8.39	8.39	1.21	46.05	9.52	9.52	1.37	57.25	
	17	6.69	4.89	0.96	30.89	6.92	6.08	0.99	32.74	7.51	7.25	1.08	37.77	8.41	8.41	1.21	46.23	9.53	9.53	1.37	57.43	
	19	-	-	-	-	10.34	6.09	1.48	65.65	10.24	7.24	1.47	64.55	10.19	8.37	1.46	64.05	10.43	9.52	1.50	66.67	
	20	-	-	-	-	12.30	6.12	1.77	88.98	12.23	7.27	1.76	88.34	12.13	8.41	1.75	87.31	12.04	9.53	1.74	86.12	
9	3	15	5.48	5.47	1.59	73.91	6.61	6.61	1.92	103.07	7.75	7.75	2.26	136.72	8.87	8.87	2.57	171.09	9.99	9.99	2.90	210.71
		17	8.09	5.45	2.36	146.96	8.02	6.61	2.34	145.43	8.14	7.76	2.36	147.16	8.88	8.88	2.58	171.53	10.01	10.01	2.90	211.32
		19	-	-	-	-	11.66	6.62	3.38	276.19	11.58	7.77	3.36	272.85	11.48	8.90	3.33	268.99	11.39	10.02	3.30	265.10
		20	-	-	-	-	13.58	6.63	3.94	361.57	13.49	7.78	3.91	357.32	13.40	8.91	3.89	353.18	13.31	10.04	3.86	348.96
	4	15	4.88	4.88	1.05	36.07	6.06	6.06	1.31	52.88	7.20	7.20	1.56	71.54	8.33	8.33	1.80	91.30	9.45	9.45	2.05	114.65
		17	6.63	4.86	1.43	61.22	6.74	6.04	1.45	63.01	7.34	7.22	1.59	73.90	8.34	8.34	1.80	91.58	9.46	9.46	2.05	114.52
		19	-	-	-	-	10.29	6.07	2.24	133.90	10.20	7.21	2.22	131.87	10.09	8.34	2.18	127.96	10.23	9.49	2.23	132.50
		20	-	-	-	-	12.21	6.08	2.66	180.95	12.13	7.23	2.65	178.83	12.04	8.37	2.63	176.51	11.94	9.49	2.60	173.91
	5	15	4.31	4.31	0.74	19.77	5.49	5.49	0.94	29.84	6.65	6.65	1.15	41.92	7.79	7.79	1.35	55.04	8.92	8.92	1.55	69.78
		17	5.25	4.30	0.91	27.68	5.79	5.49	1.00	32.79	6.67	6.67	1.16	42.18	7.80	7.80	1.35	55.03	8.94	8.94	1.55	70.02
		19	-	-	-	-	8.81	5.49	1.53	68.25	8.73	6.64	1.51	67.17	8.83	7.80	1.53	68.59	9.29	8.94	1.60	74.31
		20	-	-	-	-	10.78	5.52	1.87	97.13	10.63	6.64	1.83	93.69	10.58	7.80	1.84	94.09	10.52	8.92	1.82	92.32
6	15	3.72	3.72	0.53	11.23	4.92	4.92	0.71	18.00	6.08	6.08	0.87	25.93	7.24	7.24	1.04	35.22	8.36	8.36	1.20	44.87	
	17	4.13	3.72	0.59	13.37	5.00	4.93	0.72	18.54	6.09	6.09	0.87	26.00	7.26	7.26	1.05	35.33	8.38	8.38	1.20	45.01	
	19	-	-	-	-	7.26	4.91	1.05	35.27	7.35	6.08	1.06	36.09	7.81	7.24	1.12	39.81	8.52	8.39	1.22	46.34	
	20	-	-	-	-	9.20	4.92	1.32	52.90	9.14	6.09	1.32	52.61	9.11	7.23	1.31	52.32	9.36	8.38	1.34	54.46	

Continued:

MDVF-1400D304E																							
EWT	ΔT	Indoor temp (W.B.)	Indoor temperature (D.B.)																				
			21				23				25				27				29				
			TC	SC	WF	WPD	TC	SC	WF	WPD	TC	SC	WF	WPD	TC	SC	WF	WPD	TC	SC	WF	WPD	
°C	°C	°C	kW	kW	m³/h	kPa	kW	kW	m³/h	kPa	kW	kW	m³/h	kPa	kW	kW	m³/h	kPa	kW	kW	m³/h	kPa	
11	3	15	4.27	4.27	1.22	46.09	5.44	5.44	1.57	71.34	6.59	6.59	1.90	99.82	7.72	7.72	2.23	131.69	8.84	8.84	2.55	166.02	
		17	5.13	4.27	1.48	64.27	5.58	5.45	1.60	73.60	6.60	6.60	1.90	99.81	7.73	7.73	2.23	131.68	8.86	8.86	2.55	166.50	
		19	-	-	-	-	8.69	5.44	2.50	160.87	8.60	6.59	2.48	157.90	8.60	7.74	2.48	157.88	9.03	8.88	2.60	172.06	
		20	-	-	-	-	10.63	5.46	3.06	229.20	10.55	6.61	3.04	226.08	10.46	7.75	3.01	222.52	10.36	8.87	2.99	219.19	
	4	15	3.70	3.70	0.79	21.88	4.89	4.89	1.05	35.64	6.04	6.04	1.30	51.48	7.17	7.17	1.54	68.78	8.30	8.30	1.79	88.85	
		17	4.00	3.71	0.86	25.02	4.91	4.90	1.06	35.88	6.05	6.05	1.31	51.63	7.19	7.19	1.54	69.00	8.32	8.32	1.79	89.12	
		19	-	-	-	-	7.15	4.87	1.54	68.36	7.16	6.03	1.54	68.45	7.57	7.20	1.63	75.59	8.35	8.34	1.80	89.75	
		20	-	-	-	-	9.15	4.90	1.98	106.41	9.07	6.05	1.96	104.83	8.96	7.18	1.93	101.45	9.13	8.34	1.98	106.06	
	5	15	3.12	3.12	0.54	11.23	4.32	4.32	0.74	19.52	5.47	5.47	0.94	29.11	6.63	6.63	1.14	40.70	7.76	7.76	1.33	53.26	
		17	3.18	3.13	0.55	11.57	4.33	4.32	0.75	19.58	5.48	5.48	0.94	29.20	6.65	6.65	1.14	40.84	7.77	7.77	1.34	53.42	
		19	-	-	-	-	5.59	4.29	0.96	30.18	6.04	5.49	1.04	34.50	6.78	6.66	1.17	42.30	7.79	7.79	1.34	53.59	
		20	-	-	-	-	7.50	4.30	1.29	50.13	7.44	5.46	1.28	49.48	7.63	6.64	1.31	51.70	8.17	7.80	1.40	58.20	
	6	15	2.52	2.52	0.36	5.01	3.72	3.72	0.53	10.99	4.92	4.92	0.71	17.77	6.08	6.08	0.87	25.53	7.21	7.21	1.03	34.08	
		17	2.53	2.52	0.36	5.03	3.73	3.73	0.53	11.03	4.93	4.93	0.71	17.83	6.09	6.09	0.87	25.61	7.23	7.23	1.03	34.19	
		19	-	-	-	-	4.36	3.74	0.63	14.45	5.15	4.93	0.74	19.20	6.11	6.11	0.88	25.79	7.24	7.24	1.04	34.31	
		20	-	-	-	-	5.82	3.71	0.84	23.68	6.03	4.91	0.87	25.13	6.60	6.08	0.94	29.21	7.39	7.26	1.06	35.78	
	13	3	15	3.09	3.09	0.89	26.31	4.27	4.27	1.23	46.07	5.41	5.41	1.55	68.91	6.56	6.56	1.88	96.60	7.69	7.69	2.21	128.15
			17	3.09	3.08	0.89	26.35	4.28	4.28	1.23	46.21	5.42	5.42	1.55	69.11	6.57	6.57	1.89	96.90	7.71	7.71	2.22	128.55
			19	-	-	-	-	5.47	4.25	1.57	70.03	5.80	5.45	1.67	78.61	6.59	6.59	1.89	97.45	7.72	7.72	2.22	129.01
			20	-	-	-	-	7.41	4.27	2.13	119.95	7.36	5.43	2.13	119.87	7.39	6.59	2.13	119.98	7.90	7.75	2.29	136.21
		4	15	2.50	2.50	0.54	11.05	3.70	3.70	0.80	21.79	4.86	4.86	1.04	34.51	6.02	6.02	1.30	50.27	7.15	7.15	1.54	67.56
			17	2.51	2.51	0.54	11.08	3.71	3.71	0.80	21.86	4.87	4.87	1.05	34.62	6.03	6.03	1.30	50.42	7.17	7.17	1.54	67.77
			19	-	-	-	-	4.19	3.71	0.90	26.88	4.98	4.90	1.07	36.30	6.04	6.04	1.30	50.58	7.18	7.18	1.54	67.99
			20	-	-	-	-	5.73	3.68	1.23	45.89	5.83	4.87	1.26	47.48	6.38	6.05	1.37	55.50	7.20	7.19	1.55	68.35
5		15	1.91	1.91	0.33	3.92	3.12	3.12	0.54	10.96	4.31	4.31	0.74	19.20	5.46	5.46	0.94	28.62	6.61	6.61	1.14	39.80	
		17	1.91	1.91	0.33	3.94	3.12	3.12	0.54	10.99	4.32	4.32	0.74	19.26	5.47	5.47	0.94	28.71	6.62	6.62	1.14	39.91	
		19	-	-	-	-	3.25	3.13	0.56	11.78	4.33	4.32	0.75	19.32	5.48	5.48	0.94	28.81	6.64	6.64	1.14	40.05	
		20	-	-	-	-	4.12	3.11	0.71	17.69	4.73	4.31	0.81	22.31	5.58	5.49	0.96	29.64	6.64	6.64	1.14	40.11	
6		15	1.35	1.35	0.19	1.33	2.52	2.52	0.36	5.10	3.74	3.74	0.54	10.97	4.91	4.91	0.70	17.32	6.06	6.06	0.87	24.91	
		17	1.35	1.35	0.19	1.33	2.52	2.52	0.36	5.13	3.75	3.75	0.54	11.01	4.91	4.91	0.70	17.38	6.07	6.07	0.87	24.99	
		19	-	-	-	-	2.53	2.52	0.36	5.16	3.75	3.75	0.54	11.05	4.92	4.92	0.70	17.44	6.09	6.09	0.87	25.07	
		20	-	-	-	-	2.85	2.52	0.41	6.78	3.87	3.76	0.56	11.64	4.93	4.93	0.71	17.48	6.09	6.09	0.87	25.12	
15		3	15	-	-	-	3.08	3.08	0.88	25.45	4.25	4.25	1.22	44.53	5.40	5.40	1.55	67.72	6.55	6.55	1.90	96.41	
			17	1.89	1.89	0.54	11.03	3.08	3.08	0.88	25.53	4.26	4.26	1.22	44.68	5.41	5.41	1.55	67.92	6.56	6.56	1.90	96.72
			19	-	-	-	-	3.11	3.10	0.89	25.96	4.26	4.26	1.22	44.83	5.42	5.42	1.55	68.15	6.58	6.58	1.90	97.04
			20	-	-	-	-	3.97	3.07	1.14	39.77	4.49	4.28	1.28	48.95	5.42	5.41	1.55	68.21	6.58	6.58	1.90	97.22
		4	15	-	-	-	-	2.51	2.51	0.54	11.09	3.69	3.69	0.79	21.17	4.85	4.85	1.04	33.93	6.01	6.01	1.30	49.66
			17	-	-	-	-	2.52	2.52	0.54	11.13	3.70	3.70	0.79	21.24	4.86	4.86	1.04	34.04	6.02	6.02	1.30	49.81
			19	-	-	-	-	2.52	2.52	0.54	11.16	3.70	3.70	0.79	21.31	4.87	4.87	1.05	34.15	6.03	6.03	1.30	49.98
			20	-	-	-	-	2.77	2.53	0.60	13.11	3.73	3.72	0.80	21.60	4.87	4.87	1.05	34.21	6.04	6.04	1.30	50.07
	5	15	0.70	0.70	0.12	0.81	1.91	1.91	0.33	4.13	3.12	3.12	0.54	10.91	4.30	4.30	0.74	18.87	5.45	5.45	0.94	28.12	
		17	0.70	0.70	0.12	0.81	1.92	1.92	0.33	4.15	3.13	3.13	0.54	10.94	4.31	4.31	0.74	18.93	5.46	5.46	0.94	28.20	
		19	-	-	-	-	1.92	1.92	0.33	4.17	3.13	3.13	0.54	10.98	4.32	4.32	0.75	19.00	5.47	5.47	0.94	28.30	
		20	-	-	-	-	1.94	1.93	0.33	4.27	3.14	3.13	0.54	11.00	4.32	4.32	0.75	19.03	5.48	5.48	0.94	28.35	
	6	15	-	-	-	-	1.35	1.35	0.19	1.27	2.52	2.52	0.36	5.28	3.72	3.72	0.53	10.67	4.91	4.91	0.71	17.21	
		17	-	-	-	-	1.35	1.35	0.19	1.27	2.53	2.53	0.36	5.31	3.73	3.73	0.53	10.70	4.92	4.92	0.71	17.27	
		19	-	-	-	-	1.35	1.35	0.19	1.28	2.53	2.53	0.36	5.33	3.74	3.74	0.54	10.74	4.93	4.93	0.71	17.33	
		20	-	-	-	-	1.35	1.35	0.19	1.28	2.54	2.54	0.36	5.35	3.74	3.74	0.54	10.76	4.93	4.93	0.71	17.36	

4-row Duct Heating Capacity

EWT: Enter Water Temp. (°C) **Δt:** Temperature Difference (°C) **DB:** Dry Bulb Temp. (°C) **WB:** Wet Bulb Temp. (°C)

TC: Total Cooling Capacity (kW) **SC:** Sensible Cooling Capacity (kW) **WF:** Water Flow (m³/h) **WPD:** Water Pressure Drop (kPa)

MDVF-200D304E													
EWT	ΔT	Indoor temperature (W.B.)											
		16			18			20			22		
		TH	WF	WPD	TH	WF	WPD	TH	WF	WPD	TH	WF	WPD
°C	°C	kW	m³/h	kPa	kW	m³/h	kPa	kW	m³/h	kPa	kW	m³/h	kPa
40	8	2.20	0.24	0.63	1.91	0.21	0.44	1.63	0.18	0.29	1.36	0.15	0.20
	10	1.92	0.17	0.25	1.64	0.14	0.20	1.36	0.12	0.17	1.08	0.09	0.13
	12	1.64	0.12	0.17	1.35	0.10	0.14	1.07	0.08	0.11	0.80	0.06	0.09
	14	1.35	0.08	0.13	1.07	0.07	0.10	0.80	0.05	0.08	0.53	0.03	0.05
	16	1.07	0.06	0.09	0.80	0.04	0.07	0.52	0.03	0.05	0.29	0.02	0.03
45	8	2.93	0.32	1.13	2.63	0.28	0.94	2.34	0.25	0.76	2.04	0.22	0.56
	10	2.62	0.23	0.58	2.33	0.20	0.43	2.05	0.18	0.30	1.77	0.15	0.21
	12	2.34	0.17	0.26	2.06	0.15	0.20	1.77	0.13	0.17	1.49	0.11	0.14
	14	2.06	0.13	0.17	1.77	0.11	0.15	1.49	0.09	0.13	1.21	0.07	0.10
	16	1.77	0.10	0.14	1.49	0.08	0.11	1.21	0.07	0.09	0.94	0.05	0.07
50	8	3.67	0.40	1.61	3.37	0.36	1.39	3.07	0.33	1.19	2.77	0.30	1.00
	10	3.36	0.29	0.96	3.06	0.26	0.82	2.76	0.24	0.68	2.46	0.21	0.53
	12	3.05	0.22	0.56	2.75	0.20	0.43	2.47	0.18	0.32	2.19	0.16	0.23
	14	2.76	0.17	0.28	2.48	0.15	0.21	2.19	0.14	0.17	1.91	0.12	0.15
	16	2.49	0.13	0.18	2.20	0.12	0.15	1.91	0.10	0.13	1.63	0.09	0.11
55	8	4.40	0.47	2.15	4.09	0.44	1.90	3.79	0.41	1.67	3.49	0.38	1.45
	10	4.10	0.35	1.32	3.79	0.33	1.15	3.49	0.30	1.00	3.19	0.28	0.86
	12	3.79	0.27	0.85	3.49	0.25	0.74	3.18	0.23	0.63	2.88	0.21	0.51
	14	3.48	0.21	0.54	3.18	0.20	0.44	2.89	0.18	0.34	2.61	0.16	0.26
	16	3.19	0.17	0.30	2.90	0.16	0.23	2.62	0.14	0.18	2.33	0.13	0.15
60	8	5.13	0.55	2.76	4.82	0.52	2.48	4.51	0.49	2.21	4.21	0.45	1.96
	10	4.83	0.42	1.70	4.52	0.39	1.52	4.22	0.36	1.35	3.92	0.34	1.19
	12	4.53	0.33	1.12	4.22	0.30	0.99	3.92	0.28	0.88	3.62	0.26	0.76
	14	4.22	0.26	0.77	3.91	0.24	0.68	3.61	0.22	0.59	3.31	0.20	0.50
	16	3.91	0.21	0.53	3.61	0.19	0.44	3.31	0.18	0.35	3.02	0.16	0.28

Heating capacity

MDVF-300D304E													
EWT	ΔT	Indoor temperature (W.B.)											
		16			18			20			22		
		TH	WF	WPD	TH	WF	WPD	TH	WF	WPD	TH	WF	WPD
$^{\circ}\text{C}$	$^{\circ}\text{C}$	kW	m ³ /h	kPa	kW	m ³ /h	kPa	kW	m ³ /h	kPa	kW	m ³ /h	kPa
40	8	2.77	0.30	1.25	2.39	0.26	0.93	2.03	0.22	0.61	1.69	0.18	0.37
	10	2.39	0.21	0.51	2.05	0.18	0.34	1.70	0.15	0.25	1.35	0.12	0.20
	12	2.04	0.15	0.26	1.69	0.12	0.21	1.34	0.10	0.17	1.00	0.07	0.13
	14	1.68	0.10	0.19	1.33	0.08	0.15	0.99	0.06	0.11	0.65	0.04	0.07
	16	1.32	0.07	0.13	0.98	0.05	0.10	0.65	0.03	0.07	0.35	0.02	0.04
45	8	3.72	0.40	2.01	3.34	0.36	1.68	2.96	0.32	1.37	2.59	0.28	1.09
	10	3.31	0.29	1.14	2.93	0.25	0.90	2.56	0.22	0.66	2.21	0.19	0.44
	12	2.91	0.21	0.56	2.57	0.18	0.40	2.22	0.16	0.28	1.87	0.13	0.21
	14	2.58	0.16	0.28	2.22	0.14	0.22	1.87	0.12	0.19	1.52	0.09	0.15
	16	2.22	0.12	0.20	1.86	0.10	0.17	1.51	0.08	0.14	1.17	0.06	0.11
50	8	4.65	0.50	2.88	4.27	0.46	2.49	3.89	0.42	2.12	3.52	0.38	1.79
	10	4.26	0.37	1.71	3.88	0.34	1.46	3.50	0.30	1.23	3.13	0.27	1.01
	12	3.85	0.28	1.06	3.47	0.25	0.88	3.09	0.22	0.69	2.73	0.20	0.50
	14	3.45	0.21	0.61	3.09	0.19	0.46	2.75	0.17	0.33	2.40	0.15	0.24
	16	3.11	0.17	0.32	2.76	0.15	0.24	2.41	0.13	0.20	2.05	0.11	0.17
55	8	5.58	0.60	3.86	5.20	0.56	3.41	4.82	0.52	2.99	4.44	0.48	2.60
	10	5.20	0.45	2.35	4.82	0.42	2.06	4.44	0.38	1.79	4.06	0.35	1.54
	12	4.81	0.35	1.51	4.43	0.32	1.31	4.05	0.29	1.13	3.67	0.26	0.95
	14	4.41	0.27	1.01	4.03	0.25	0.87	3.64	0.22	0.72	3.27	0.20	0.56
	16	4.00	0.22	0.65	3.63	0.20	0.51	3.27	0.18	0.39	2.93	0.16	0.29
60	8	6.52	0.70	4.97	6.13	0.66	4.46	5.74	0.62	3.99	5.37	0.58	3.54
	10	6.14	0.53	3.06	5.75	0.50	2.73	5.37	0.46	2.43	4.99	0.43	2.14
	12	5.76	0.41	2.00	5.37	0.39	1.78	4.99	0.36	1.57	4.61	0.33	1.37
	14	5.37	0.33	1.38	4.98	0.31	1.21	4.60	0.28	1.06	4.22	0.26	0.91
	16	4.97	0.27	0.97	4.58	0.25	0.84	4.20	0.23	0.72	3.82	0.21	0.60

Heating capacity

MDVF-400D304E													
EWT	ΔT	Indoor temperature (W.B.)											
		16			18			20			22		
		TH	WF	WPD	TH	WF	WPD	TH	WF	WPD	TH	WF	WPD
°C	°C	kW	m³/h	kPa	kW	m³/h	kPa	kW	m³/h	kPa	kW	m³/h	kPa
40	8	3.60	0.39	2.27	3.12	0.34	1.78	2.65	0.29	1.34	2.19	0.24	0.86
	10	3.10	0.27	1.16	2.64	0.23	0.78	2.21	0.19	0.48	1.77	0.15	0.31
	12	2.66	0.19	0.48	2.22	0.16	0.33	1.77	0.13	0.26	1.33	0.10	0.20
	14	2.22	0.14	0.29	1.77	0.11	0.23	1.32	0.08	0.17	0.88	0.05	0.12
	16	1.77	0.10	0.21	1.33	0.07	0.16	0.89	0.05	0.11	0.45	0.02	0.05
45	8	4.77	0.51	3.57	4.29	0.46	2.99	3.82	0.41	2.45	3.35	0.36	1.96
	10	4.29	0.37	2.06	3.82	0.33	1.68	3.34	0.29	1.34	2.87	0.25	1.00
	12	3.80	0.27	1.23	3.32	0.24	0.92	2.87	0.21	0.63	2.44	0.18	0.40
	14	3.33	0.21	0.60	2.89	0.18	0.41	2.45	0.15	0.30	2.00	0.12	0.23
	16	2.91	0.16	0.32	2.46	0.13	0.26	2.01	0.11	0.21	1.56	0.08	0.17
50	8	5.94	0.64	5.09	5.46	0.59	4.40	4.98	0.54	3.76	4.51	0.49	3.17
	10	5.47	0.47	3.04	4.99	0.43	2.60	4.52	0.39	2.19	4.05	0.35	1.82
	12	5.00	0.36	1.91	4.52	0.32	1.61	4.04	0.29	1.33	3.56	0.26	1.08
	14	4.50	0.28	1.25	4.02	0.25	1.01	3.55	0.22	0.76	3.10	0.19	0.53
	16	4.02	0.22	0.73	3.57	0.19	0.53	3.13	0.17	0.37	2.69	0.15	0.27
55	8	7.10	0.77	6.79	6.62	0.71	6.01	6.14	0.66	5.27	5.66	0.61	4.59
	10	6.65	0.57	4.15	6.16	0.53	3.65	5.68	0.49	3.17	5.21	0.45	2.73
	12	6.18	0.44	2.68	5.69	0.41	2.34	5.22	0.37	2.01	4.74	0.34	1.71
	14	5.71	0.35	1.82	5.22	0.32	1.57	4.76	0.29	1.33	4.27	0.26	1.11
	16	5.22	0.28	1.25	4.73	0.26	1.06	4.25	0.23	0.86	3.78	0.20	0.65
60	8	8.27	0.89	8.72	7.78	0.84	7.84	7.30	0.79	7.01	6.82	0.74	6.23
	10	7.81	0.67	5.36	7.33	0.63	4.79	6.84	0.59	4.26	6.36	0.55	3.76
	12	7.35	0.53	3.54	6.86	0.49	3.15	6.38	0.46	2.78	5.90	0.42	2.43
	14	6.89	0.42	2.44	6.40	0.39	2.16	5.92	0.36	1.89	5.44	0.34	1.63
	16	6.42	0.35	1.73	5.93	0.32	1.52	5.45	0.29	1.31	4.97	0.27	1.12

Heating capacity

MDVF-500D304E													
EWT	ΔT	Indoor temperature (W.B.)											
		16			18			20			22		
		TH	WF	WPD	TH	WF	WPD	TH	WF	WPD	TH	WF	WPD
°C	°C	kW	m ³ /h	kPa	kW	m ³ /h	kPa	kW	m ³ /h	kPa	kW	m ³ /h	kPa
40	8	4.32	0.47	3.09	3.76	0.41	2.44	3.20	0.34	1.86	2.64	0.28	1.33
	10	3.74	0.32	1.67	3.17	0.27	1.22	2.63	0.23	0.77	2.12	0.18	0.43
	12	3.17	0.23	0.76	2.66	0.19	0.47	2.13	0.15	0.32	1.60	0.12	0.24
	14	2.67	0.16	0.35	2.13	0.13	0.28	1.60	0.10	0.21	1.07	0.07	0.14
	16	2.14	0.12	0.25	1.61	0.09	0.19	1.07	0.06	0.13	0.54	0.03	0.07
45	8	5.71	0.62	4.87	5.15	0.55	4.07	4.59	0.49	3.34	4.03	0.43	2.68
	10	5.15	0.44	2.81	4.59	0.40	2.30	4.03	0.35	1.84	3.46	0.30	1.43
	12	4.58	0.33	1.70	4.01	0.29	1.36	3.45	0.25	1.00	2.91	0.21	0.65
	14	3.99	0.25	0.96	3.45	0.21	0.66	2.93	0.18	0.43	2.41	0.15	0.29
	16	3.48	0.19	0.46	2.96	0.16	0.33	2.42	0.13	0.26	1.88	0.10	0.20
50	8	7.10	0.77	6.93	6.53	0.70	5.99	5.96	0.64	5.12	5.40	0.58	4.32
	10	6.55	0.57	4.15	5.99	0.52	3.55	5.42	0.47	2.99	4.86	0.42	2.48
	12	6.00	0.43	2.61	5.42	0.39	2.20	4.86	0.35	1.83	4.30	0.31	1.48
	14	5.43	0.33	1.71	4.86	0.30	1.42	4.28	0.26	1.14	3.72	0.23	0.85
	16	4.84	0.26	1.12	4.28	0.23	0.85	3.74	0.20	0.60	3.22	0.17	0.40
55	8	8.48	0.91	9.25	7.91	0.85	8.18	7.34	0.79	7.18	6.77	0.73	6.25
	10	7.94	0.69	5.66	7.37	0.64	4.97	6.80	0.59	4.32	6.24	0.54	3.72
	12	7.40	0.53	3.66	6.83	0.49	3.18	6.26	0.45	2.74	5.69	0.41	2.33
	14	6.85	0.42	2.48	6.28	0.39	2.14	5.71	0.35	1.82	5.14	0.32	1.52
	16	6.28	0.34	1.71	5.70	0.31	1.46	5.13	0.28	1.22	4.56	0.25	0.99
60	8	9.87	1.06	11.83	9.29	1.00	10.63	8.72	0.94	9.56	8.15	0.88	8.49
	10	9.34	0.80	7.30	8.76	0.75	6.53	8.18	0.71	5.81	7.61	0.66	5.12
	12	8.80	0.63	4.84	8.22	0.59	4.31	7.64	0.55	3.79	7.07	0.51	3.31
	14	8.25	0.51	3.33	7.68	0.47	2.94	7.10	0.44	2.58	6.53	0.40	2.23
	16	7.70	0.41	2.37	7.12	0.38	2.07	6.55	0.35	1.80	5.98	0.32	1.54

Heating capacity

MDVF-600D304E													
EWT	ΔT	Indoor temperature (W.B.)											
		16			18			20			22		
		TH	WF	WPD	TH	WF	WPD	TH	WF	WPD	TH	WF	WPD
°C	°C	kW	m³/h	kPa	kW	m³/h	kPa	kW	m³/h	kPa	kW	m³/h	kPa
40	8	5.61	0.60	6.30	4.89	0.53	4.98	4.18	0.45	3.81	3.47	0.37	2.78
	10	4.92	0.42	3.47	4.20	0.36	2.65	3.48	0.30	1.92	2.78	0.24	1.14
	12	4.21	0.30	1.95	3.49	0.25	1.27	2.81	0.20	0.70	2.12	0.15	0.41
	14	3.52	0.22	0.83	2.83	0.17	0.50	2.13	0.13	0.36	1.43	0.09	0.25
	16	2.86	0.15	0.44	2.15	0.12	0.33	1.44	0.08	0.23	0.73	0.04	0.12
45	8	7.37	0.79	9.82	6.64	0.72	8.21	5.92	0.64	6.75	5.21	0.56	5.41
	10	6.68	0.58	5.70	5.96	0.51	4.68	5.24	0.45	3.76	4.53	0.39	2.93
	12	6.00	0.43	3.50	5.27	0.38	2.81	4.55	0.33	2.19	3.83	0.28	1.63
	14	5.29	0.33	2.19	4.56	0.28	1.68	3.85	0.24	1.13	3.16	0.19	0.67
	16	4.58	0.25	1.24	3.88	0.21	0.80	3.19	0.17	0.49	2.49	0.13	0.35
50	8	9.12	0.98	13.91	8.39	0.90	12.03	7.66	0.83	10.28	6.95	0.75	8.67
	10	8.45	0.73	8.36	7.72	0.67	7.15	6.99	0.60	6.03	6.28	0.54	5.01
	12	7.76	0.56	5.29	7.04	0.51	4.47	6.31	0.45	3.71	5.60	0.40	3.02
	14	7.08	0.44	3.49	6.35	0.39	2.90	5.62	0.35	2.36	4.90	0.30	1.87
	16	6.38	0.34	2.36	5.65	0.30	1.92	4.92	0.27	1.50	4.20	0.23	1.05
55	8	10.88	1.18	18.63	10.13	1.10	16.47	9.40	1.02	14.45	8.67	0.94	12.50
	10	10.21	0.88	11.36	9.47	0.82	9.97	8.74	0.76	8.67	8.02	0.69	7.47
	12	9.53	0.68	7.36	8.79	0.63	6.41	8.06	0.58	5.52	7.34	0.53	4.70
	14	8.85	0.55	5.02	8.12	0.50	4.32	7.39	0.46	3.68	6.67	0.41	3.09
	16	8.16	0.44	3.49	7.42	0.40	2.97	6.69	0.36	2.49	5.97	0.32	2.05
60	8	12.63	1.36	23.67	11.89	1.28	21.26	11.14	1.20	18.98	10.42	1.13	16.95
	10	11.97	1.03	14.69	11.22	0.97	13.07	10.47	0.90	11.61	9.75	0.84	10.24
	12	11.30	0.81	9.71	10.55	0.76	8.63	9.81	0.71	7.61	9.09	0.65	6.66
	14	10.62	0.65	6.70	9.87	0.61	5.91	9.14	0.56	5.17	8.41	0.52	4.48
	16	9.94	0.54	4.79	9.20	0.50	4.19	8.46	0.46	3.63	7.73	0.42	3.11

Heating capacity

MDVF-800D304E													
EWT	ΔT	Indoor temperature (W.B.)											
		16			18			20			22		
		TH	WF	WPD	TH	WF	WPD	TH	WF	WPD	TH	WF	WPD
$^{\circ}\text{C}$	$^{\circ}\text{C}$	kW	m ³ /h	kPa	kW	m ³ /h	kPa	kW	m ³ /h	kPa	kW	m ³ /h	kPa
40	8	6.01	0.65	1.43	5.18	0.56	1.10	4.39	0.47	0.75	3.65	0.39	0.45
	10	5.14	0.44	0.62	4.41	0.38	0.41	3.68	0.32	0.28	2.92	0.25	0.21
	12	4.42	0.32	0.28	3.66	0.26	0.23	2.90	0.21	0.18	2.15	0.16	0.13
	14	3.63	0.22	0.20	2.88	0.18	0.16	2.13	0.13	0.12	1.40	0.09	0.08
	16	2.86	0.15	0.14	2.12	0.11	0.11	1.39	0.08	0.07	0.74	0.04	0.04
45	8	8.07	0.87	2.30	7.25	0.78	1.91	6.44	0.69	1.56	5.62	0.61	1.24
	10	7.18	0.62	1.30	6.35	0.55	1.05	5.53	0.48	0.79	4.77	0.41	0.54
	12	6.29	0.45	0.69	5.53	0.40	0.49	4.81	0.35	0.33	4.07	0.29	0.24
	14	5.57	0.34	0.32	4.81	0.30	0.25	4.05	0.25	0.20	3.29	0.20	0.16
	16	4.80	0.26	0.22	4.04	0.22	0.18	3.28	0.18	0.15	2.53	0.14	0.11
50	8	10.11	1.09	3.30	9.28	1.00	2.85	8.47	0.91	2.43	7.65	0.83	2.05
	10	9.26	0.80	1.96	8.44	0.73	1.67	7.61	0.66	1.40	6.80	0.59	1.16
	12	8.37	0.60	1.21	7.54	0.54	1.02	6.71	0.48	0.82	5.91	0.43	0.61
	14	7.46	0.46	0.73	6.68	0.41	0.56	5.93	0.37	0.40	5.20	0.32	0.28
	16	6.71	0.36	0.39	5.97	0.32	0.29	5.22	0.28	0.22	4.46	0.24	0.18
55	8	12.14	1.31	4.42	11.31	1.22	3.91	10.48	1.13	3.43	9.66	1.04	2.98
	10	11.31	0.98	2.69	10.48	0.91	2.36	9.65	0.83	2.05	8.84	0.76	1.76
	12	10.46	0.75	1.73	9.63	0.69	1.50	8.80	0.63	1.29	7.98	0.57	1.09
	14	9.59	0.59	1.16	8.75	0.54	0.99	7.92	0.49	0.84	7.10	0.44	0.67
	16	8.67	0.47	0.77	7.85	0.42	0.62	7.07	0.38	0.47	6.32	0.34	0.35
60	8	14.17	1.53	5.70	13.33	1.44	5.13	12.50	1.35	4.58	11.67	1.26	4.07
	10	13.34	1.15	3.49	12.51	1.08	3.14	11.68	1.01	2.79	10.86	0.94	2.46
	12	12.52	0.90	2.30	11.67	0.84	2.04	10.85	0.78	1.80	10.03	0.72	1.57
	14	11.67	0.72	1.57	10.84	0.67	1.39	10.01	0.62	1.21	9.18	0.57	1.05
	16	10.81	0.58	1.11	9.97	0.54	0.97	9.13	0.49	0.83	8.29	0.45	0.70

Heating capacity

MDVF-1000D304E													
EWT	ΔT	Indoor temperature (W.B.)											
		16			18			20			22		
		TH	WF	WPD	TH	WF	WPD	TH	WF	WPD	TH	WF	WPD
°C	°C	kW	m³/h	kPa	kW	m³/h	kPa	kW	m³/h	kPa	kW	m³/h	kPa
40	8	7.81	0.84	2.43	6.78	0.73	1.91	5.75	0.62	1.44	4.71	0.51	0.97
	10	6.69	0.58	1.27	5.68	0.49	0.88	4.74	0.41	0.54	3.82	0.33	0.32
	12	5.71	0.41	0.53	4.78	0.34	0.35	3.81	0.27	0.26	2.85	0.21	0.19
	14	4.77	0.29	0.29	3.79	0.23	0.23	2.83	0.17	0.17	1.88	0.12	0.11
	16	3.79	0.20	0.21	2.83	0.15	0.15	1.88	0.10	0.10	0.94	0.05	0.05
45	8	10.40	1.12	3.85	9.36	1.01	3.22	8.33	0.90	2.64	7.31	0.79	2.11
	10	9.34	0.81	2.20	8.30	0.72	1.80	7.25	0.63	1.44	6.21	0.54	1.10
	12	8.23	0.59	1.32	7.18	0.52	1.02	6.18	0.45	0.71	5.24	0.38	0.46
	14	7.15	0.44	0.68	6.21	0.38	0.46	5.29	0.33	0.31	4.32	0.27	0.23
	16	6.27	0.34	0.34	5.30	0.29	0.26	4.32	0.23	0.21	3.35	0.18	0.16
50	8	12.98	1.40	5.51	11.93	1.29	4.77	10.89	1.17	4.07	9.86	1.06	3.43
	10	11.94	1.03	3.28	10.89	0.94	2.81	9.86	0.85	2.37	8.83	0.76	1.96
	12	10.88	0.78	2.06	9.83	0.71	1.73	8.78	0.63	1.43	7.74	0.56	1.16
	14	9.78	0.60	1.33	8.72	0.54	1.09	7.68	0.47	0.85	6.68	0.41	0.60
	16	8.67	0.47	0.82	7.68	0.41	0.60	6.74	0.36	0.42	5.81	0.31	0.29
55	8	15.55	1.68	7.38	14.49	1.56	6.53	13.45	1.45	5.73	12.41	1.34	4.99
	10	14.53	1.26	4.50	13.48	1.16	3.95	12.43	1.07	3.44	11.40	0.99	2.96
	12	13.49	0.97	2.90	12.44	0.89	2.52	11.39	0.82	2.17	10.36	0.74	1.84
	14	12.45	0.77	1.96	11.39	0.70	1.68	10.34	0.64	1.43	9.30	0.57	1.19
	16	11.35	0.61	1.34	10.29	0.55	1.14	9.23	0.50	0.94	8.19	0.44	0.74
60	8	18.13	1.96	9.51	17.05	1.84	8.55	15.99	1.73	7.65	14.95	1.62	6.80
	10	17.10	1.47	5.83	16.04	1.38	5.21	14.99	1.29	4.64	13.94	1.20	4.09
	12	16.08	1.16	3.84	15.02	1.08	3.41	13.97	1.00	3.01	12.93	0.93	2.64
	14	15.06	0.93	2.65	14.00	0.86	2.33	12.95	0.80	2.04	11.90	0.73	1.77
	16	14.01	0.76	1.87	12.95	0.70	1.64	11.88	0.64	1.42	10.85	0.58	1.21

Heating capacity

MDVF-1200D304E													
EWT	ΔT	Indoor temperature (W.B.)											
		16			18			20			22		
		TH	WF	WPD	TH	WF	WPD	TH	WF	WPD	TH	WF	WPD
$^{\circ}\text{C}$	$^{\circ}\text{C}$	kW	m ³ /h	kPa	kW	m ³ /h	kPa	kW	m ³ /h	kPa	kW	m ³ /h	kPa
40	8	9.34	1.01	3.99	8.13	0.88	3.15	6.92	0.75	2.40	5.71	0.62	1.73
	10	8.09	0.70	2.16	6.86	0.59	1.62	5.67	0.49	1.05	4.58	0.40	0.60
	12	6.83	0.49	1.05	5.73	0.41	0.65	4.63	0.33	0.40	3.48	0.25	0.29
	14	5.78	0.36	0.45	4.63	0.29	0.34	3.48	0.21	0.25	2.33	0.14	0.17
	16	4.64	0.25	0.31	3.49	0.19	0.23	2.34	0.13	0.16	1.19	0.06	0.08
45	8	12.36	1.33	6.29	11.14	1.20	5.27	9.93	1.07	4.32	8.74	0.94	3.47
	10	11.15	0.96	3.63	9.93	0.86	2.98	8.72	0.75	2.38	7.51	0.65	1.85
	12	9.93	0.72	2.20	8.70	0.63	1.76	7.46	0.54	1.34	6.28	0.45	0.90
	14	8.62	0.53	1.30	7.44	0.46	0.91	6.33	0.39	0.59	5.23	0.32	0.37
	16	7.51	0.41	0.64	6.40	0.35	0.43	5.26	0.28	0.32	4.10	0.22	0.24
50	8	15.37	1.66	8.97	14.14	1.52	7.76	12.92	1.39	6.64	11.71	1.26	5.61
	10	14.20	1.23	5.37	12.97	1.12	4.59	11.76	1.02	3.88	10.55	0.91	3.22
	12	12.99	0.93	3.38	11.76	0.85	2.85	10.55	0.76	2.37	9.33	0.67	1.92
	14	11.77	0.73	2.21	10.52	0.65	1.83	9.30	0.57	1.48	8.07	0.50	1.14
	16	10.50	0.57	1.47	9.26	0.50	1.15	8.07	0.44	0.83	6.95	0.38	0.56
55	8	18.37	1.98	11.98	17.13	1.85	10.61	15.90	1.71	9.32	14.68	1.58	8.12
	10	17.22	1.49	7.33	15.98	1.38	6.44	14.76	1.28	5.61	13.54	1.17	4.84
	12	16.02	1.15	4.74	14.80	1.06	4.13	13.58	0.98	3.56	12.36	0.89	3.03
	14	14.86	0.92	3.22	13.62	0.84	2.77	12.40	0.76	2.36	11.17	0.69	1.98
	16	13.63	0.73	2.22	12.39	0.67	1.89	11.15	0.60	1.58	9.92	0.53	1.30
60	8	21.39	2.31	15.42	20.14	2.17	13.81	18.89	2.04	12.35	17.66	1.90	10.98
	10	20.23	1.74	9.48	18.98	1.64	8.48	17.74	1.53	7.54	16.52	1.42	6.66
	12	19.08	1.37	6.29	17.83	1.28	5.59	16.60	1.19	4.94	15.37	1.11	4.33
	14	17.90	1.10	4.32	16.66	1.03	3.82	15.42	0.95	3.35	14.20	0.87	2.90
	16	16.71	0.90	3.07	15.47	0.83	2.69	14.23	0.77	2.33	13.01	0.70	2.00

Heating capacity

MDVF-1400D304E													
EWT	ΔT	Indoor temperature (W.B.)											
		16			18			20			22		
		TH	WF	WPD	TH	WF	WPD	TH	WF	WPD	TH	WF	WPD
°C	°C	kW	m³/h	kPa	kW	m³/h	kPa	kW	m³/h	kPa	kW	m³/h	kPa
40	8	11.04	1.19	39.03	9.66	1.04	30.96	8.30	0.90	23.79	6.94	0.75	17.48
	10	9.77	0.84	21.54	8.40	0.72	16.58	7.03	0.61	12.21	5.65	0.49	8.42
	12	8.49	0.61	12.51	7.10	0.51	9.22	5.71	0.41	6.36	4.30	0.31	3.92
	14	7.16	0.44	7.24	5.75	0.35	4.99	4.34	0.27	2.78	2.96	0.18	1.04
	16	5.79	0.31	3.94	4.40	0.24	1.97	2.99	0.16	0.91	1.53	0.08	0.47
45	8	14.39	1.55	60.55	12.99	1.40	50.45	11.63	1.26	41.79	10.27	1.11	33.54
	10	13.15	1.14	35.23	11.76	1.01	28.94	10.40	0.90	23.46	9.04	0.78	18.42
	12	11.89	0.86	21.68	10.52	0.76	17.59	9.14	0.66	13.80	7.76	0.56	10.42
	14	10.61	0.65	13.77	9.22	0.57	10.81	7.83	0.48	8.18	6.43	0.40	5.86
	16	9.31	0.50	8.85	7.90	0.43	6.69	6.48	0.35	4.79	5.06	0.27	3.00
50	8	17.73	1.91	85.17	16.35	1.76	74.20	14.95	1.61	63.19	13.59	1.47	53.72
	10	16.51	1.42	51.16	15.12	1.31	44.01	13.75	1.19	37.30	12.37	1.07	30.90
	12	15.28	1.10	32.76	13.89	1.00	27.79	12.50	0.90	23.16	11.12	0.80	18.86
	14	14.03	0.87	21.79	12.63	0.78	18.17	11.24	0.69	14.86	9.87	0.61	11.88
	16	12.75	0.69	14.73	11.34	0.61	12.06	9.95	0.54	9.62	8.55	0.46	7.43
55	8	21.10	2.27	114.11	19.69	2.12	101.05	18.30	1.97	88.78	16.90	1.82	76.91
	10	19.87	1.71	69.44	18.48	1.60	61.35	17.09	1.48	53.49	15.70	1.35	45.91
	12	18.67	1.34	45.59	17.25	1.24	39.59	15.86	1.14	34.23	14.48	1.04	29.26
	14	17.42	1.07	31.04	16.01	0.99	26.73	14.62	0.90	22.82	13.23	0.82	19.20
	16	16.17	0.87	21.74	14.76	0.80	18.57	13.36	0.72	15.63	11.97	0.65	12.93
60	8	24.45	2.63	144.89	23.02	2.47	130.31	21.63	2.33	117.24	20.24	2.18	104.24
	10	23.26	2.01	90.31	21.83	1.88	80.45	20.42	1.76	71.53	19.02	1.64	63.14
	12	22.07	1.59	59.90	20.61	1.48	53.06	19.21	1.38	47.05	17.82	1.28	41.24
	14	20.80	1.28	41.39	19.39	1.19	36.65	17.98	1.11	32.07	16.59	1.02	27.94
	16	19.56	1.05	29.60	18.16	0.98	26.05	16.75	0.90	22.63	15.35	0.83	19.45

11.Static Pressure Graphs

How to read the diagram:

- The vertical axis is the External Static Pressure (Pa) while the horizontal axis represents the Air Flow (m³/h).
- The fan performance curves are for the “1-Super High”, “2-High”, “3-Medium” and “4-Low” fan speed.
- The dotted line stands for reserved fan speed.

MDVF-200D302E

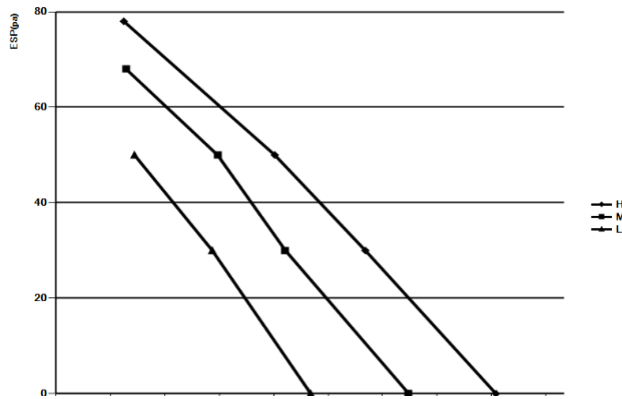

MDVF-300D302E

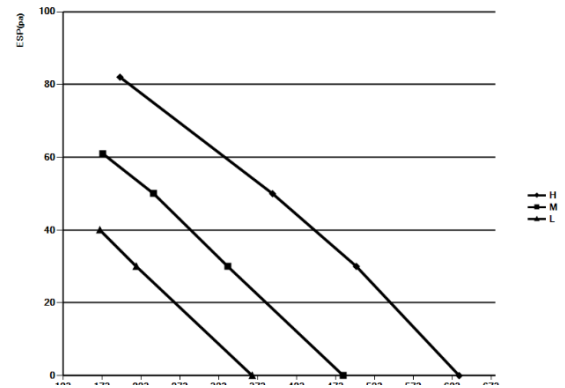

MDVF-400D302E

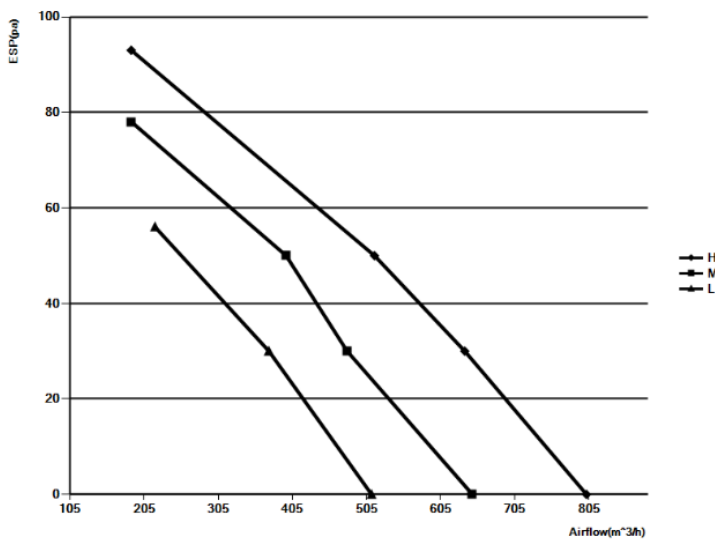

MDVF-500D302E

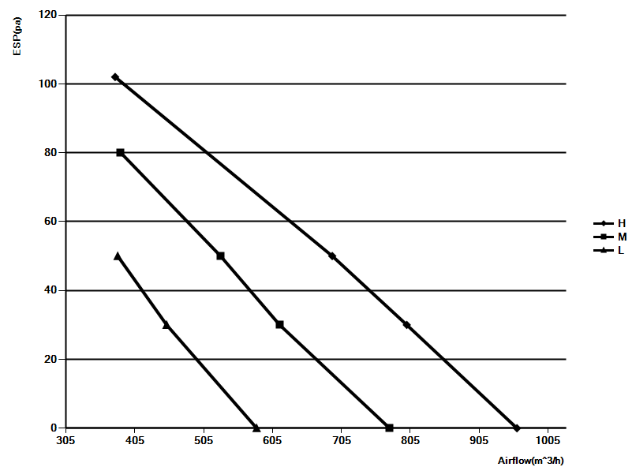

MDVF-600D302E

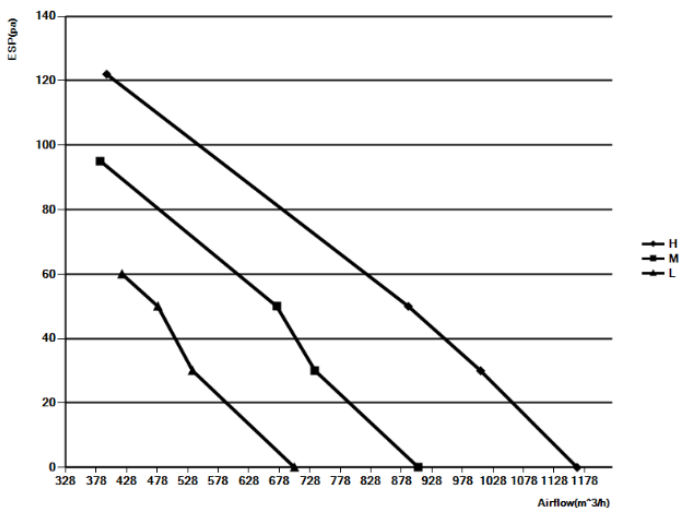

MDVF-800D302E

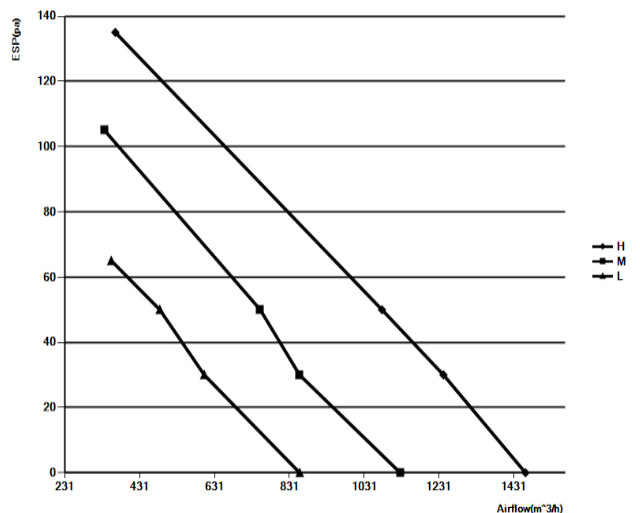

Static pressure graphs

MDVF-1000D302E

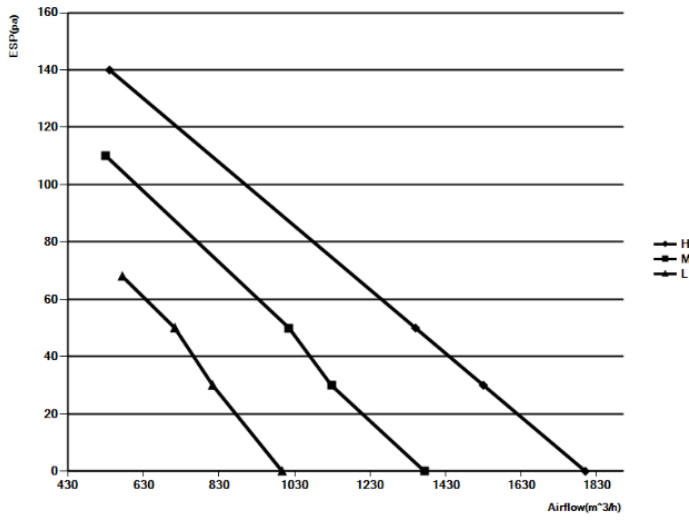

MDVF-1200D302E

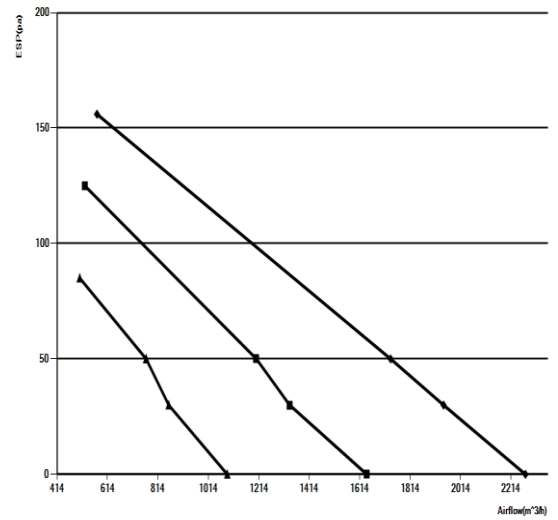

MDVF-1400D302E

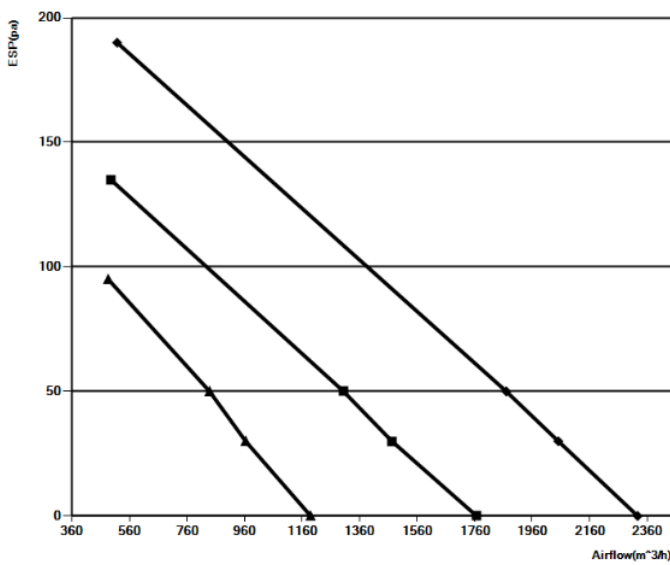

MDVF-200D3E

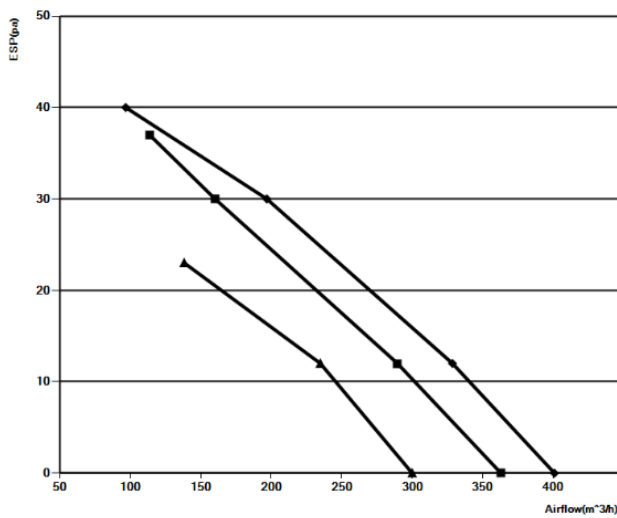

MDVF-200D303E

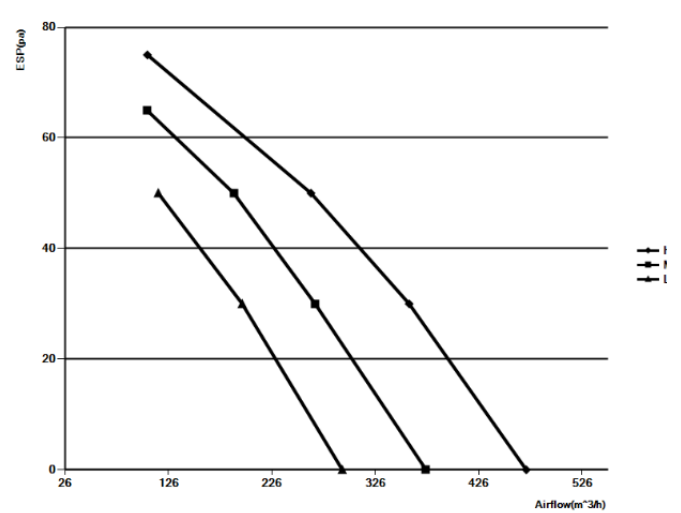

Static pressure graphs

MDVF-300D3E

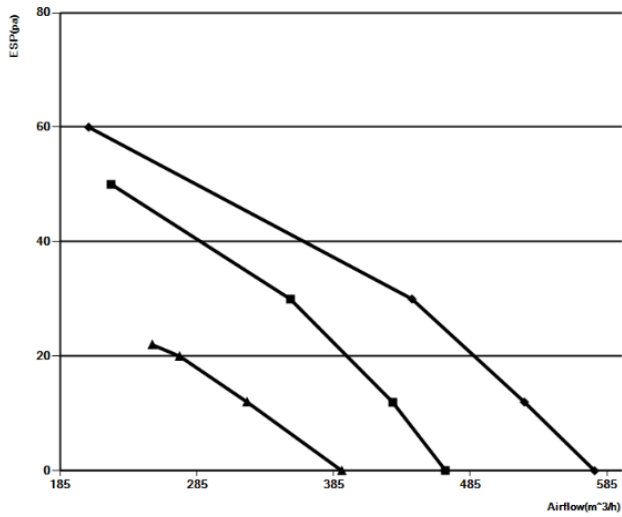

MDVF-300D303E

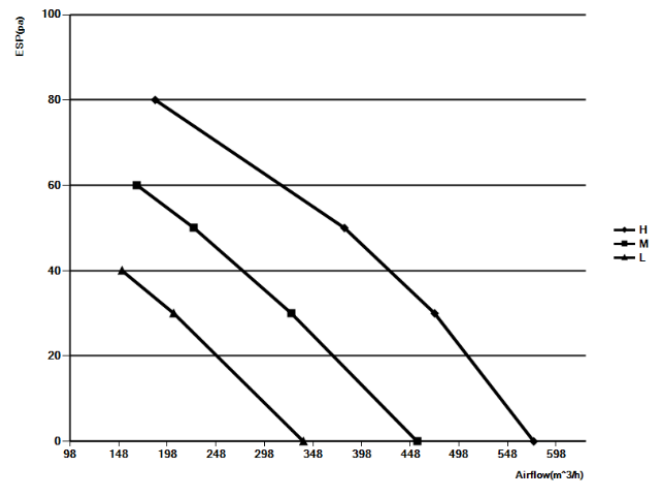

MDVF-400D3E

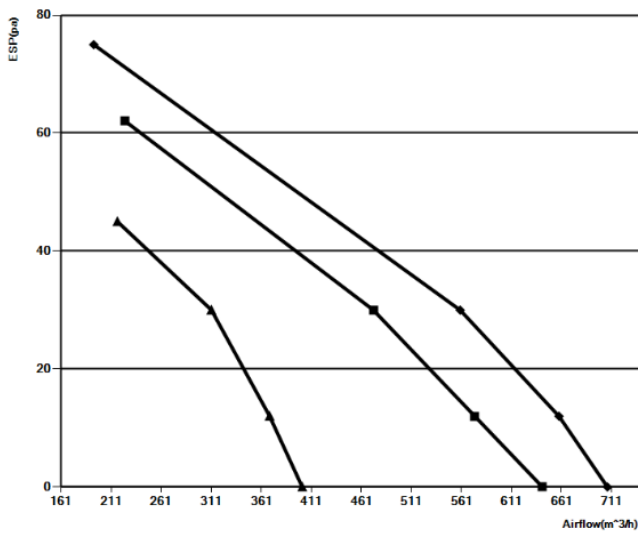

MDVF-400D303E

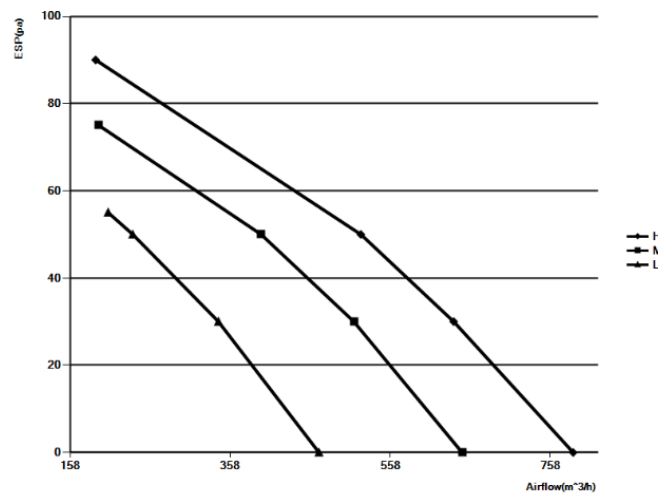

MDVF-500D3E

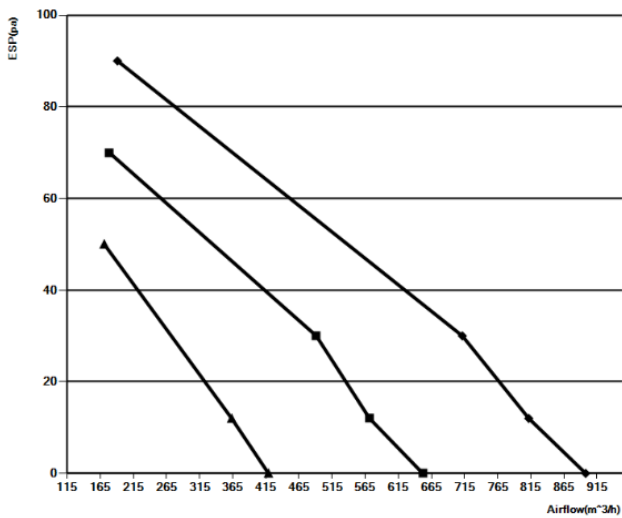

MDVF-500D303E

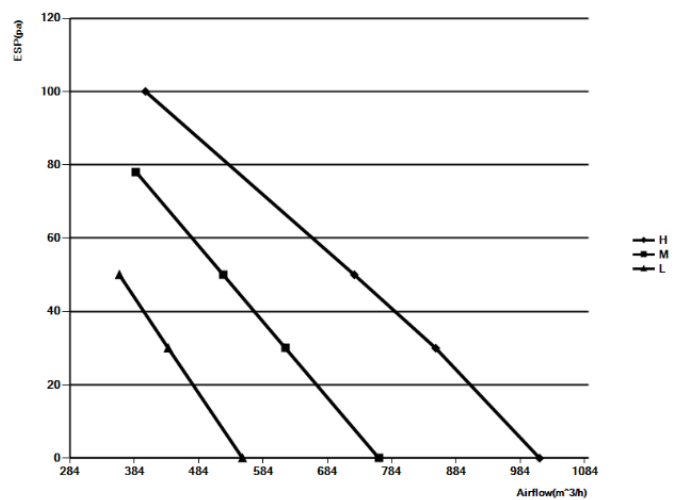

Static pressure graphs

MDVF-600D3E

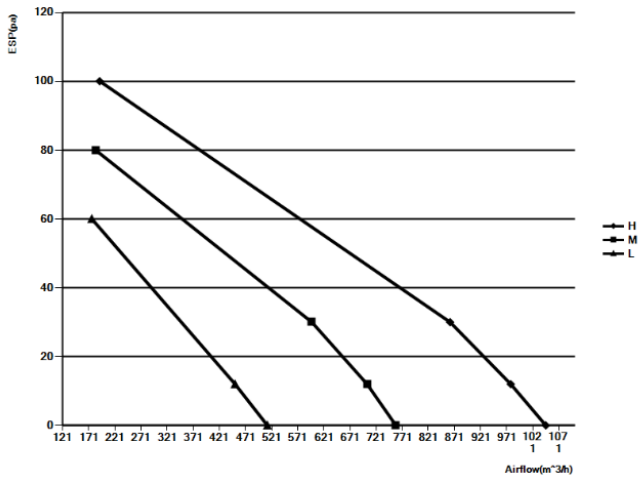

MDVF-600D303E

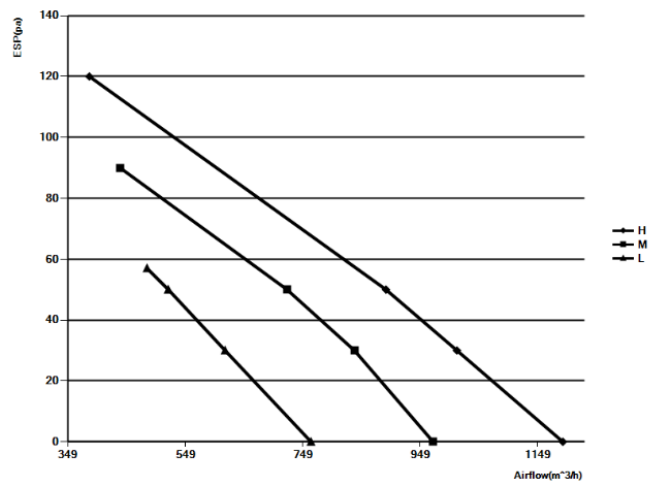

MDVF-800D3E

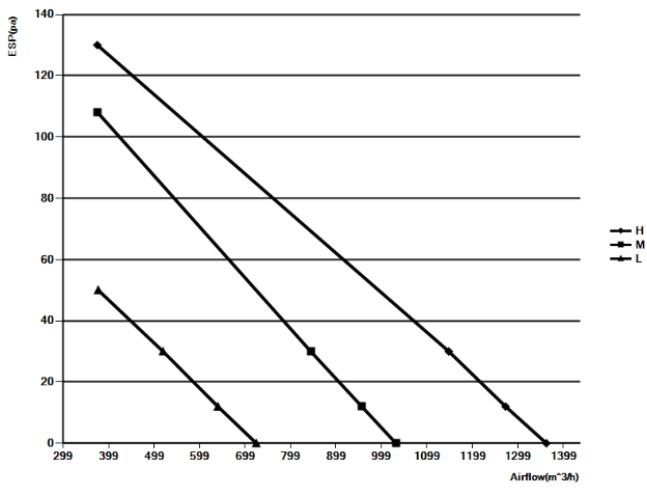

MDVF-800D303E

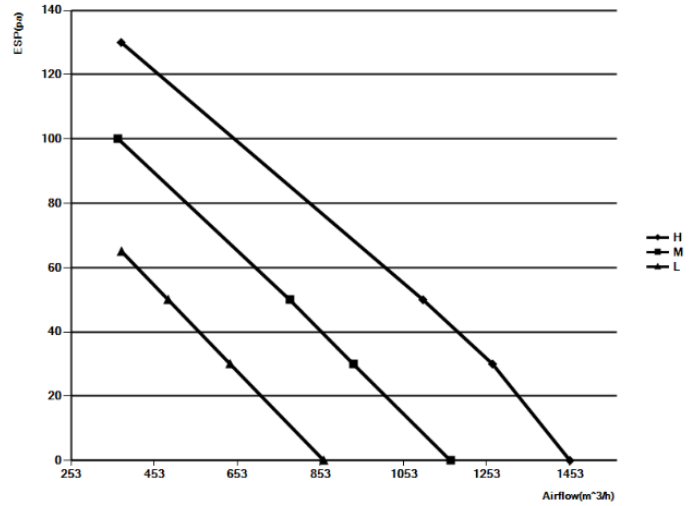

MDVF-1000D3E

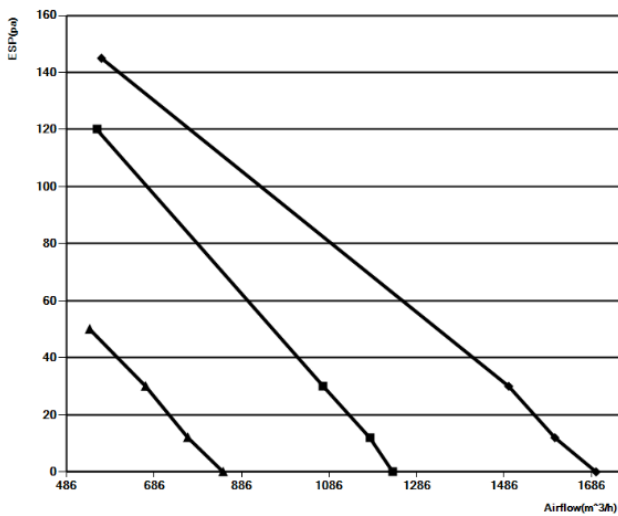

MDVF-1000D303E

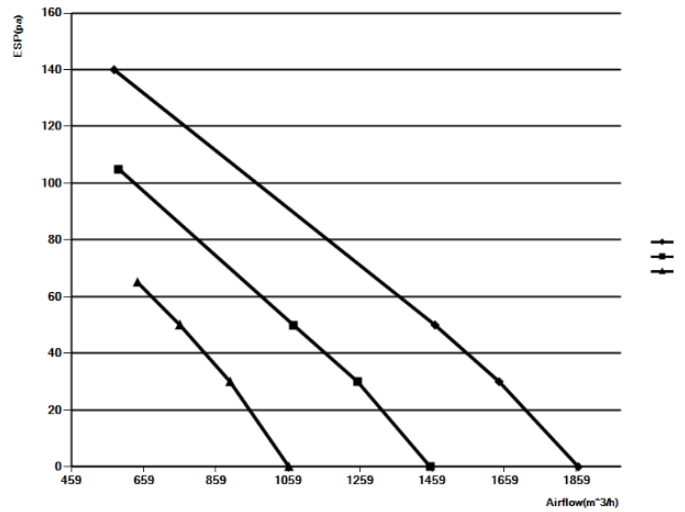

Static pressure graphs

MDVF-1200D3E

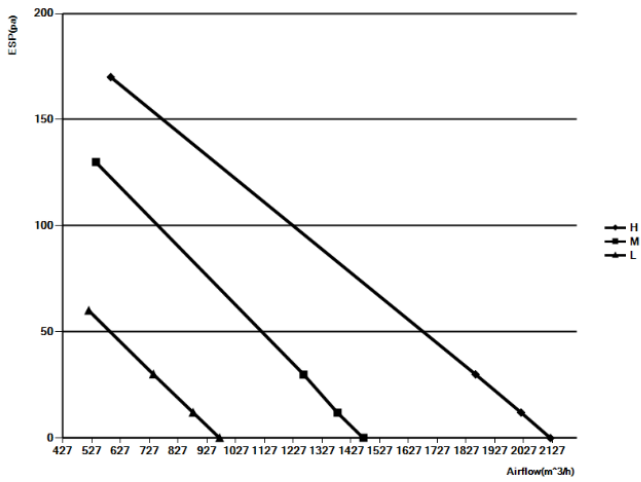

MDVF-1200D303E

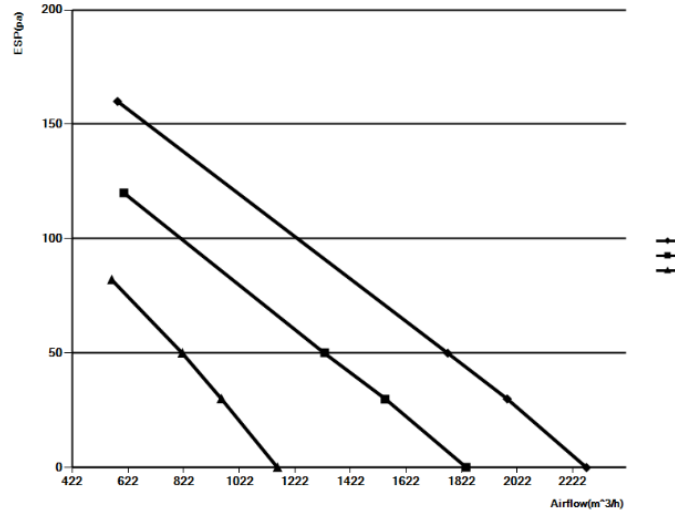

MDVF-1400D3E

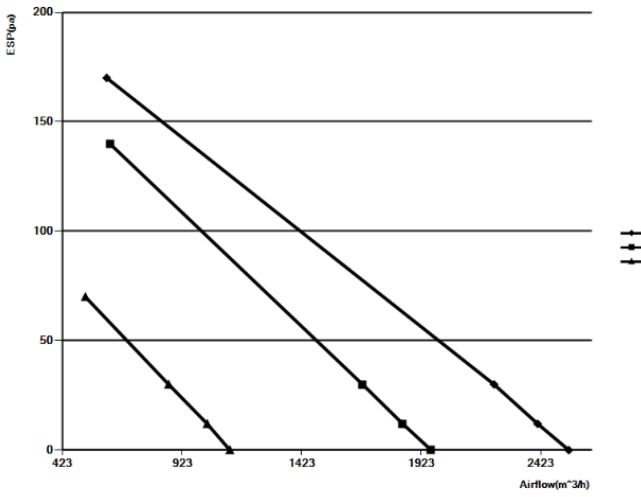

MDVF-1400D303E

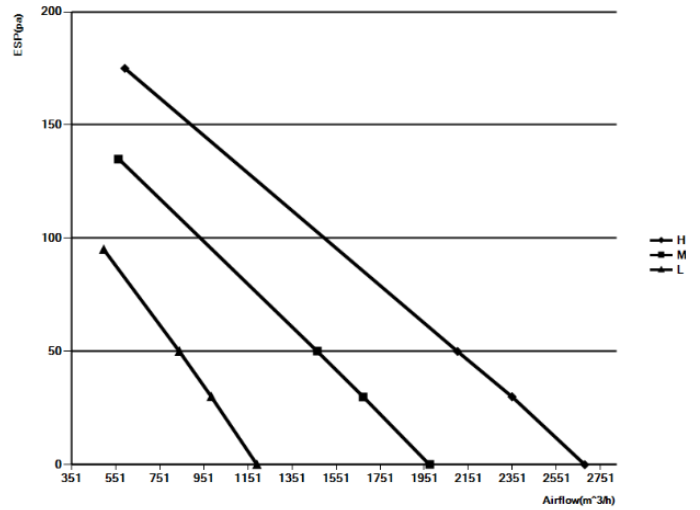

Static pressure graphs

MDVF-200D304E

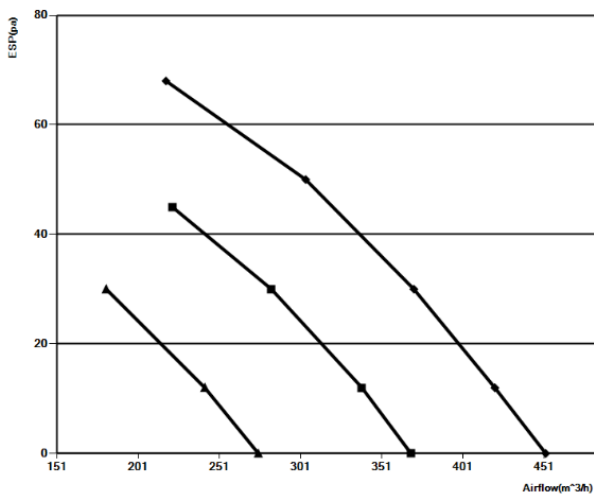

MDVF-300D304E

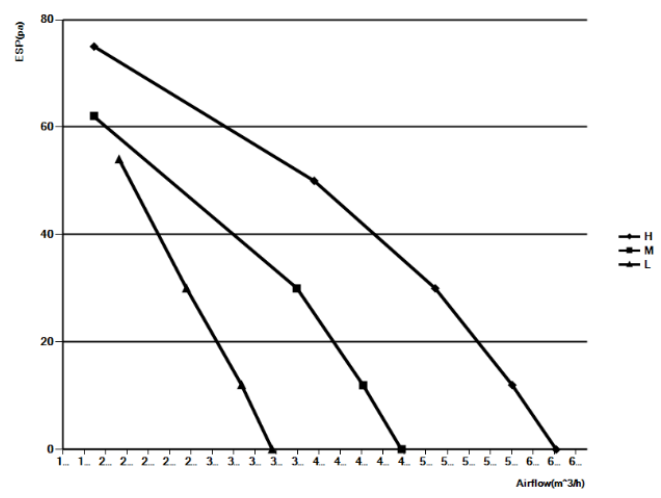

MDVF-400D304E

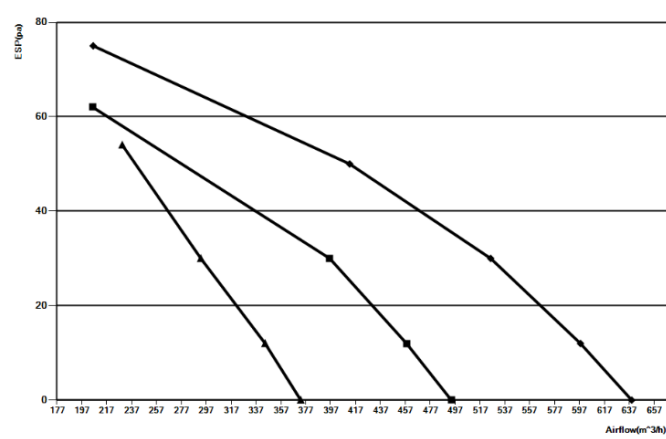

MDVF-500D304E

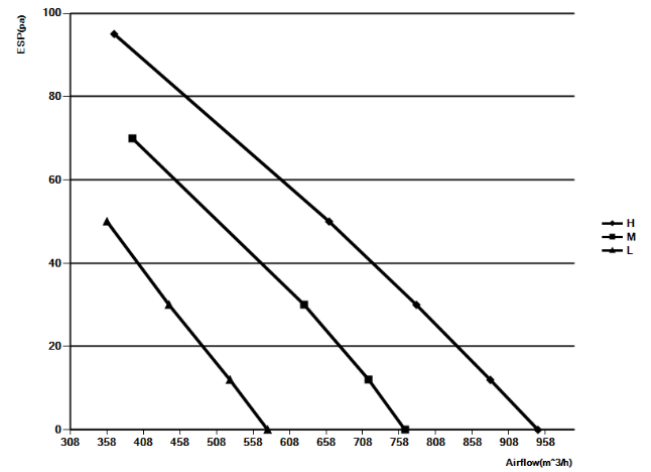

MDVF-600D304E

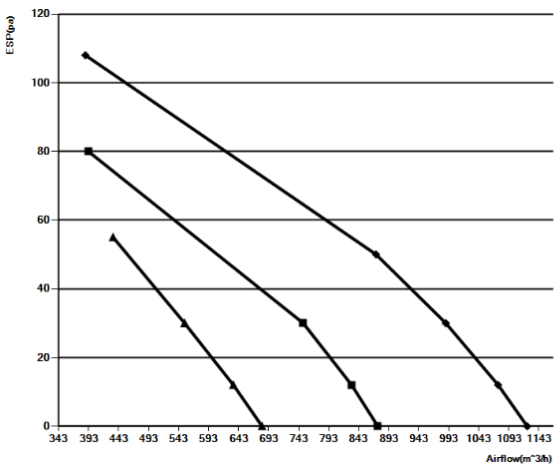

MDVF-800D304E

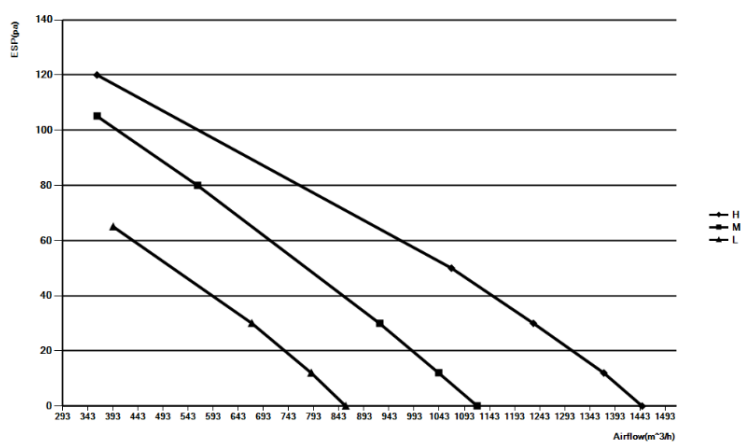

Static pressure graphs

MDVF-1000D304E

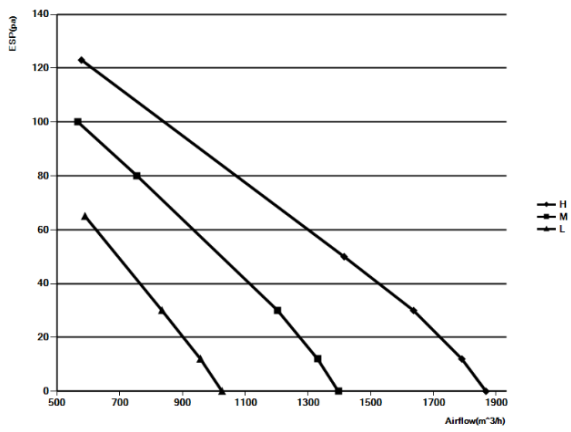

MDVF-1200D304E

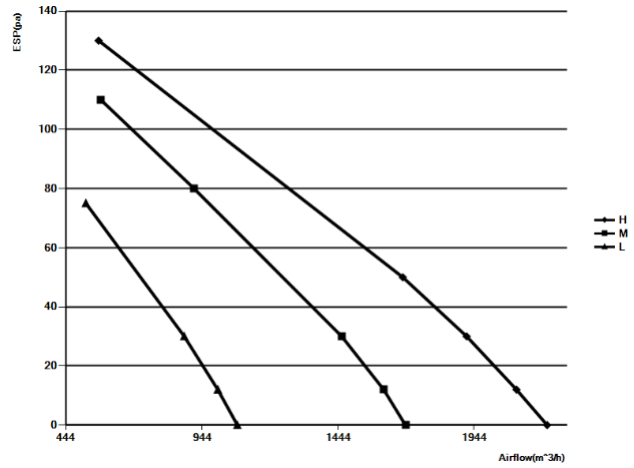

MDVF-1400D304E

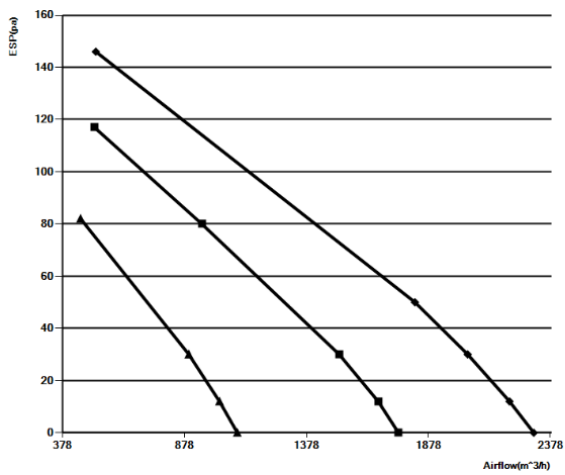

12.Exploded View

2-row Unit

MDVF-200D302E

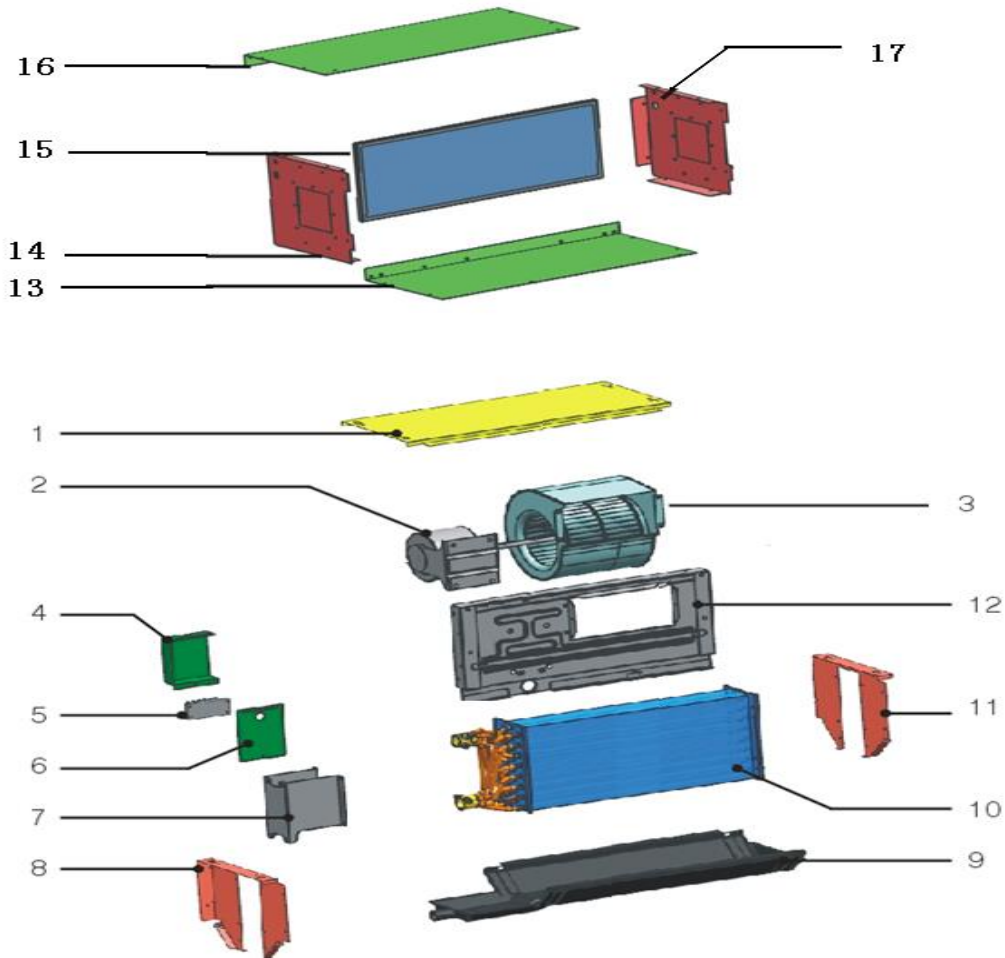

No.	Part Name	Quantity
1	Top panel ass'y	1
2	Motor ass'y	1
3	Fan ass'y	1
4	Motor junction box cover	1
5	Wire joint, 5p	1
6	Motor junction box	1
7	Installing board	1
8	Left panel	1
9	Drain tray ass'y	1
10	Evaporator ass'y	1
11	Right panel	1
12	Middle clapboard ass'y	1
13	Rear below cover plate ass'y	1
14	Left cover plate ass'y	1
15	Air filter	1
16	Up cover plate ass'y	1
17	Right cover plate ass'y	1

MDVF-300D302E,MDVF-400D302E, MDVF-500D302E,MDVF-600D302E

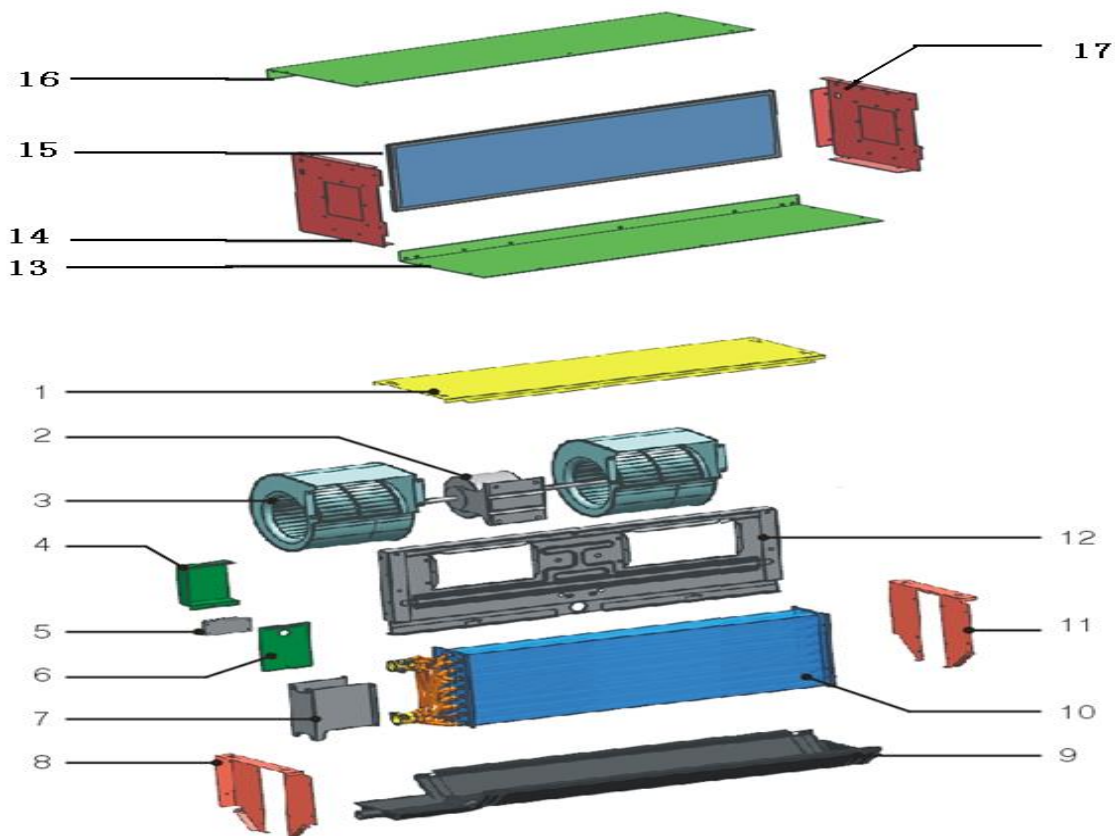

No.	Part Name	Quantity
1	Top panel assy	1
2	Motor ass'y	1
3	Fan ass'y	2
4	Motor junction box cover	1
5	Wire joint, 5p	1
6	Motor junction box	1
7	Installing board	1
8	Left panel	1
9	Drain tray assy	1
10	Evaporator ass'y	1
11	Right panel	1
12	Middle clapboard assy	1
13	Rear below cover plate ass'y	1
14	Left cover plate ass'y	1
16	Up cover plate ass'y	1
17	Right cover plate ass'y	1

MDVF-800D302E, MDVF-1000D302E, MDVF-1200D302E, MDVF-1400D302E

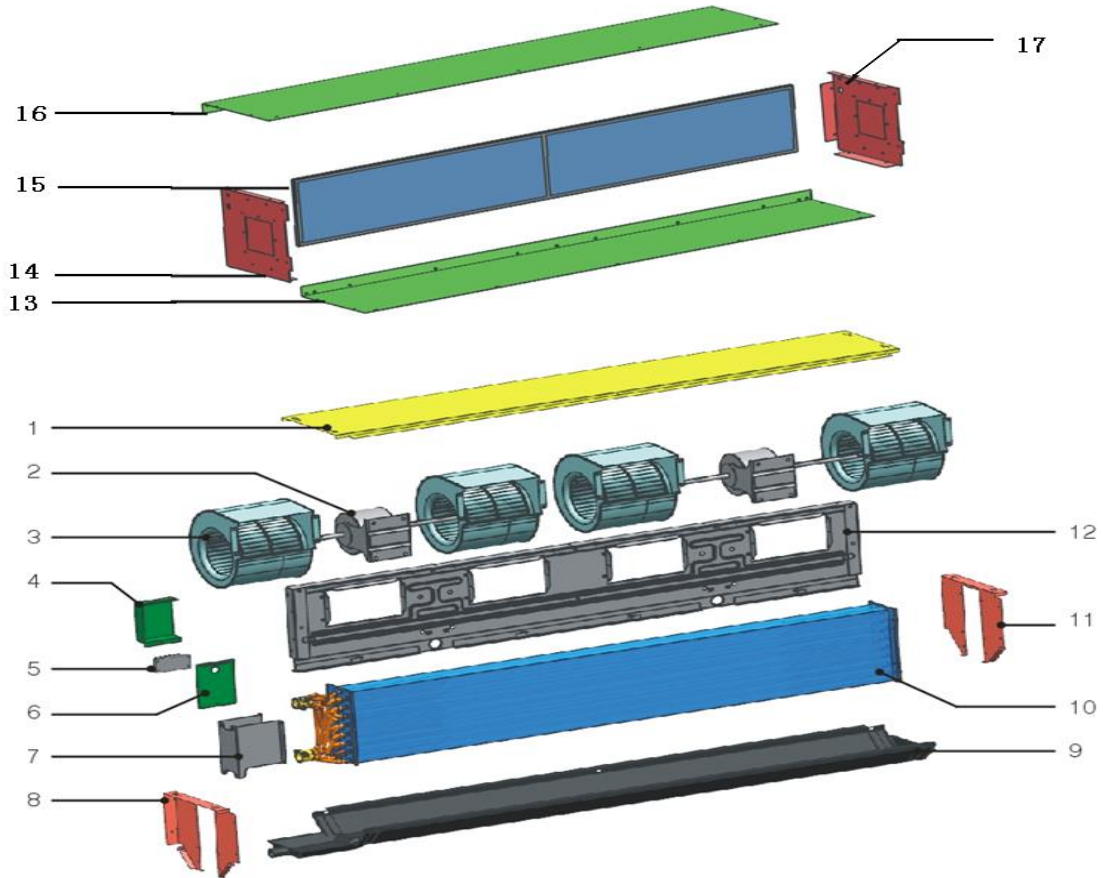

No.	Part Name	Quantity
1	Top panel ass'y	1
2	Motor ass'y	2
3	Fan ass'y	4
4	Motor junction box cover	1
5	Wire joint, 5p	1
6	Motor junction box	1
7	Installing board	1
8	Left panel	1
9	Drain tray ass'y	1
10	Evaporator ass'y	1
11	Right panel	1
12	Middle clapboard ass'y	1
13	Rear below cover plate ass'y	1
14	Left cover plate ass'y	1
15	Filter	1
16	Up cover plate ass'y	1
17	Right cover plate ass'y	1

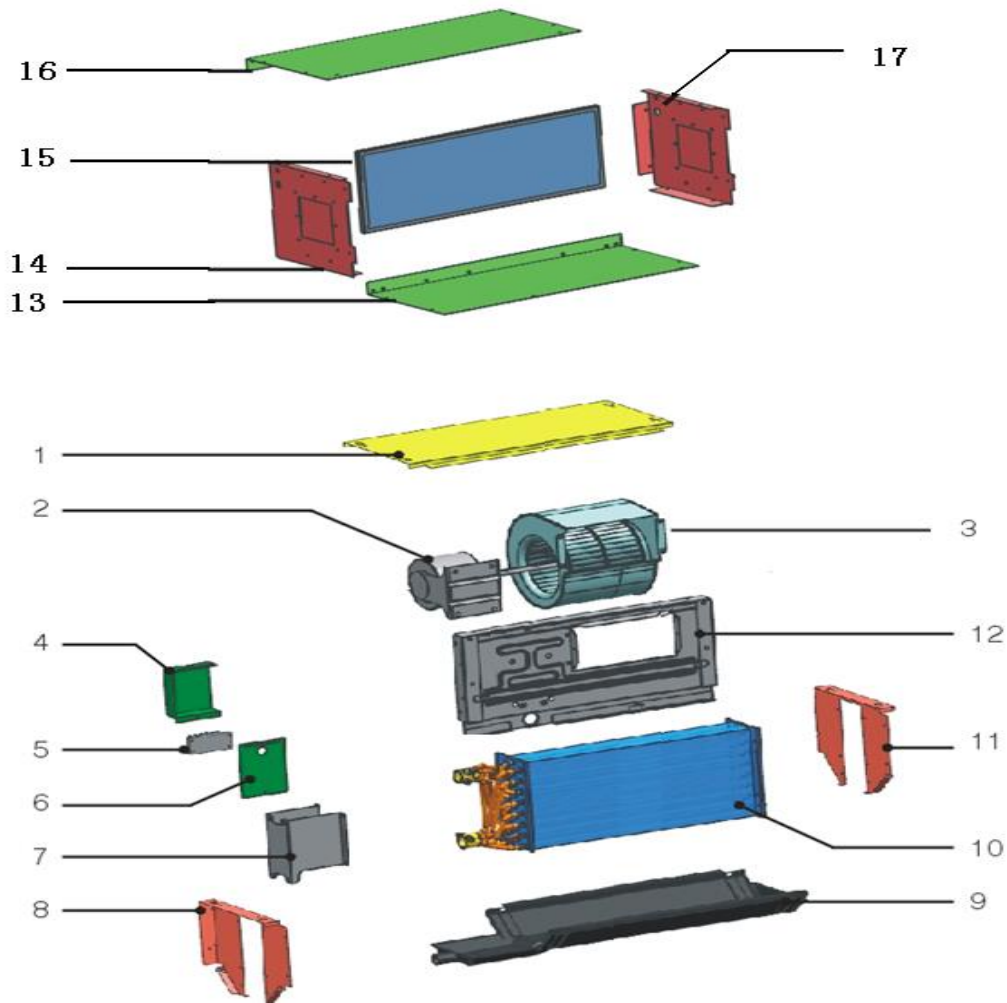
3-row Unit**MDVF-200D3E, MDVF-200D303E**

No.	Part Name	Quantity
1	Top panel assy	1
2	Motor ass'y	1
3	Fan ass'y	1
4	Motor junction box cover	1
5	Wire joint, 5p	1
6	Motor junction box	1
7	Installing board	1
8	Left panel	1
9	Drain tray assy	1
10	Evaporator assembly	1
11	Right panel	1
12	Middle clapboard assy	1
13	Rear below cover plate ass'y	1
14	Left cover plate ass'y	1
15	Air filter	1
16	Up cover plate ass'y	1
17	Right cover plate ass'y	1

MDVF-300D3E, MDVF-300D303E, MDVF-400D3E, MDVF-400D303E, MDVF-500D3E, MDVF-500D303E, MDVF-600D3E, MDVF-600D303E

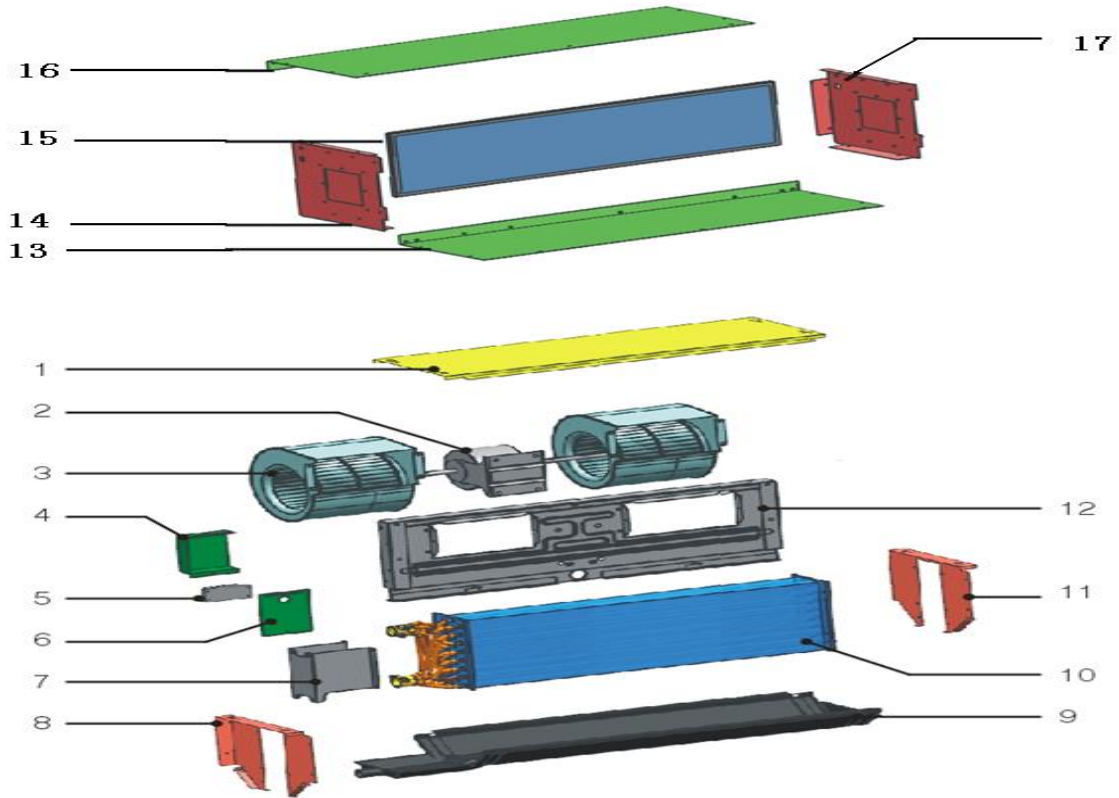

No.	Part Name	Quantity
1	Top panel ass'y	1
2	Motor ass'y	1
3	Fan ass'y	2
4	Motor junction box cover	1
5	Wire joint, 5p	1
6	Motor junction box	1
7	Installing board	1
8	Left panel	1
9	Drain tray ass'y	1
10	Evaporator assembly	1
11	Right panel	1
12	Middle clapboard ass'y	1
13	Rear below cover plate ass'y	1
14	Left cover plate ass'y	1
15	Air filter	1
16	Up cover plate ass'y	1
17	Right cover plate ass'y	1
18		

MDVF-800D3E, MDVF-800D303E, MDVF-1000D3E, MDVF-1000D303E, MDVF-1200D3E, MDVF-1200D303E, MDVF-1400D3E, MDVF-1400D303E

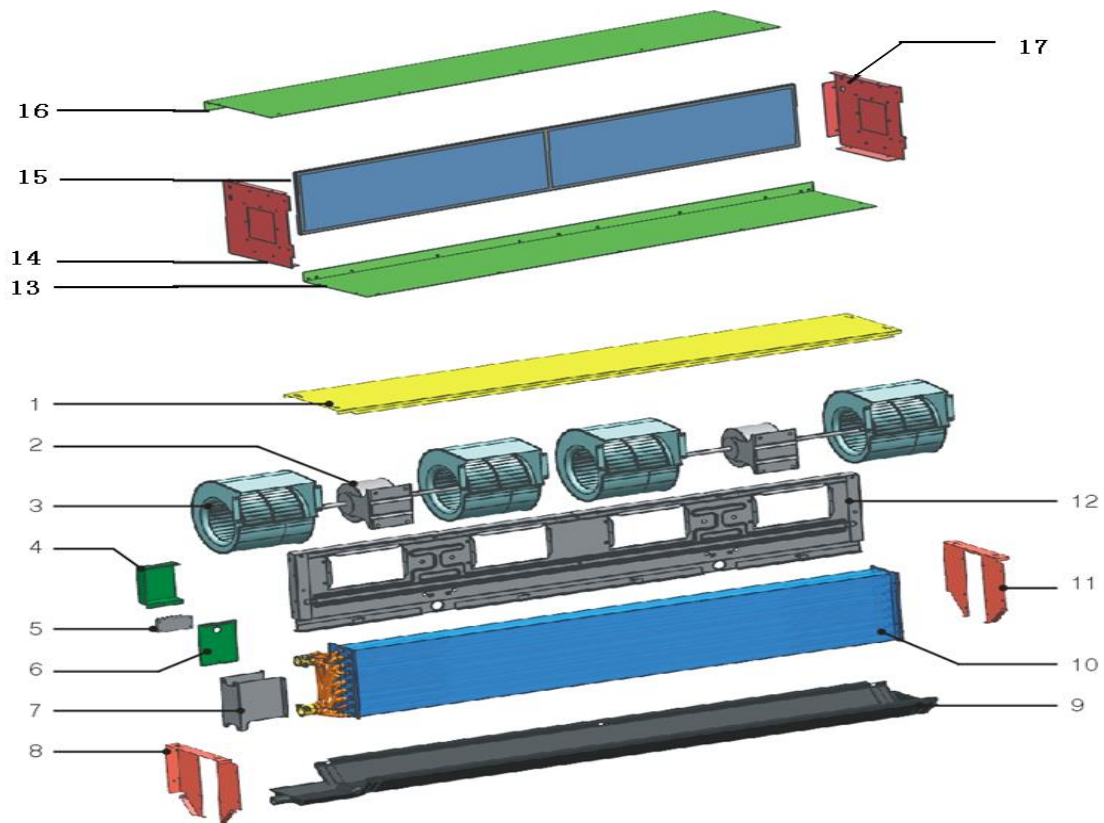

No.	Part Name	Quantity
1	Top panel ass'y	1
2	Motor ass'y	2
3	Fan ass'y	4
4	Motor junction box cover	1
5	Wire joint, 5p	1
6	Motor junction box	1
7	Installing board	1
8	Left panel	1
9	Drain tray ass'y	1
10	Evaporator assembly	1
11	Right panel	1
12	Middle clapboard ass'y	1
13	Rear below cover plate ass'y	1
14	Left cover plate ass'y	1
15	Filter	1
16	Up cover plate ass'y	1
17	Right cover plate ass'y	1

4-row Unit

MDVF-200D304E

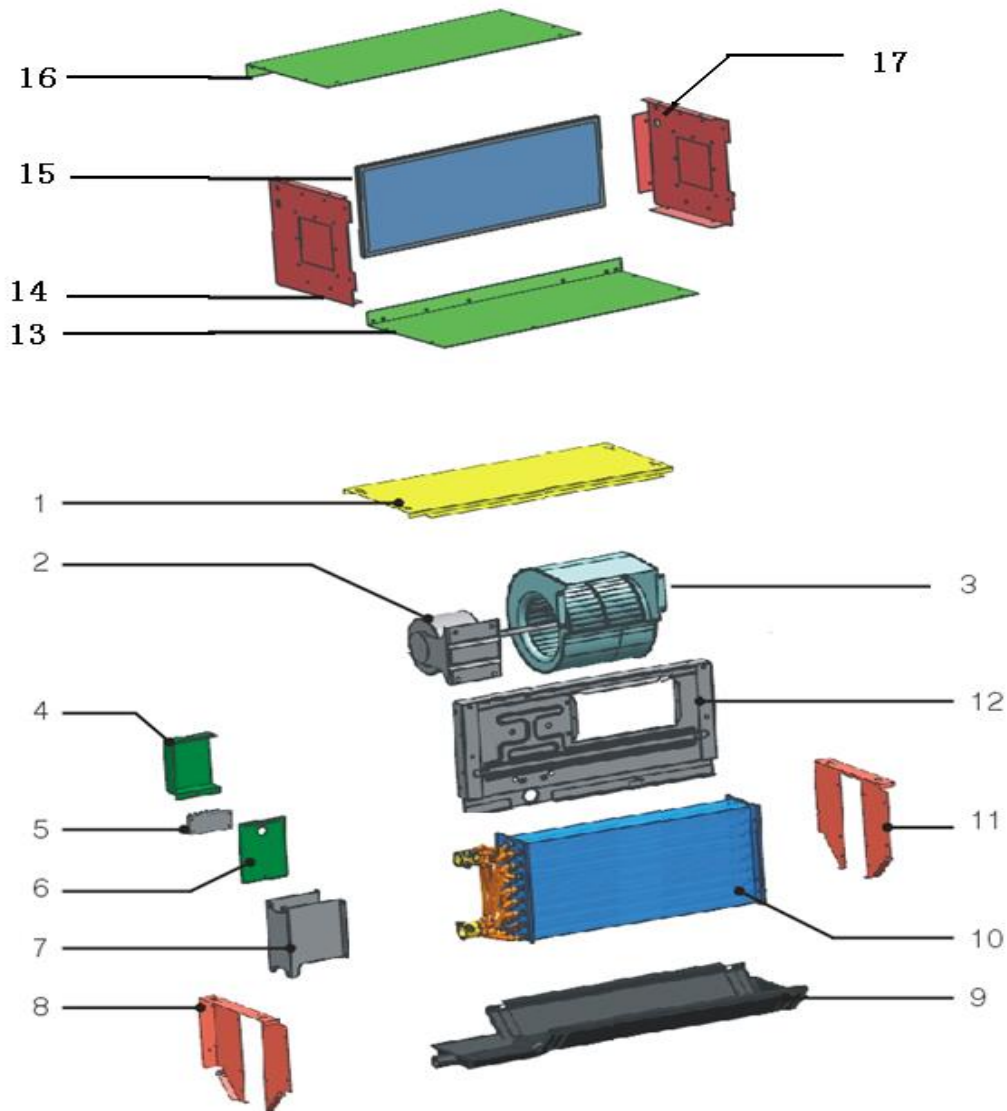

No.	Part Name	Quantity
1	Top panel ass'y	1
2	Motor ass'y	1
3	Fan ass'y	1
4	Motor junction box cover	1
5	Wire joint, 5p	1
6	Motor junction box	1
7	Water collector installation board	1
8	Left panel	1
9	Drain tray ass'y	1
10	Evaporater assembly	1
11	Right panel	1
12	Middle clapboard ass'y	1
13	Rear below cover plate ass'y	1
14	Left cover plate ass'y	1
15	Air filter	1
16	Up cover plate ass'y	1
17	Right cover plate ass'y	1

MDVF-300D304E, MDVF-400D304E, MDVF-500D304E, MDVF-600D304E

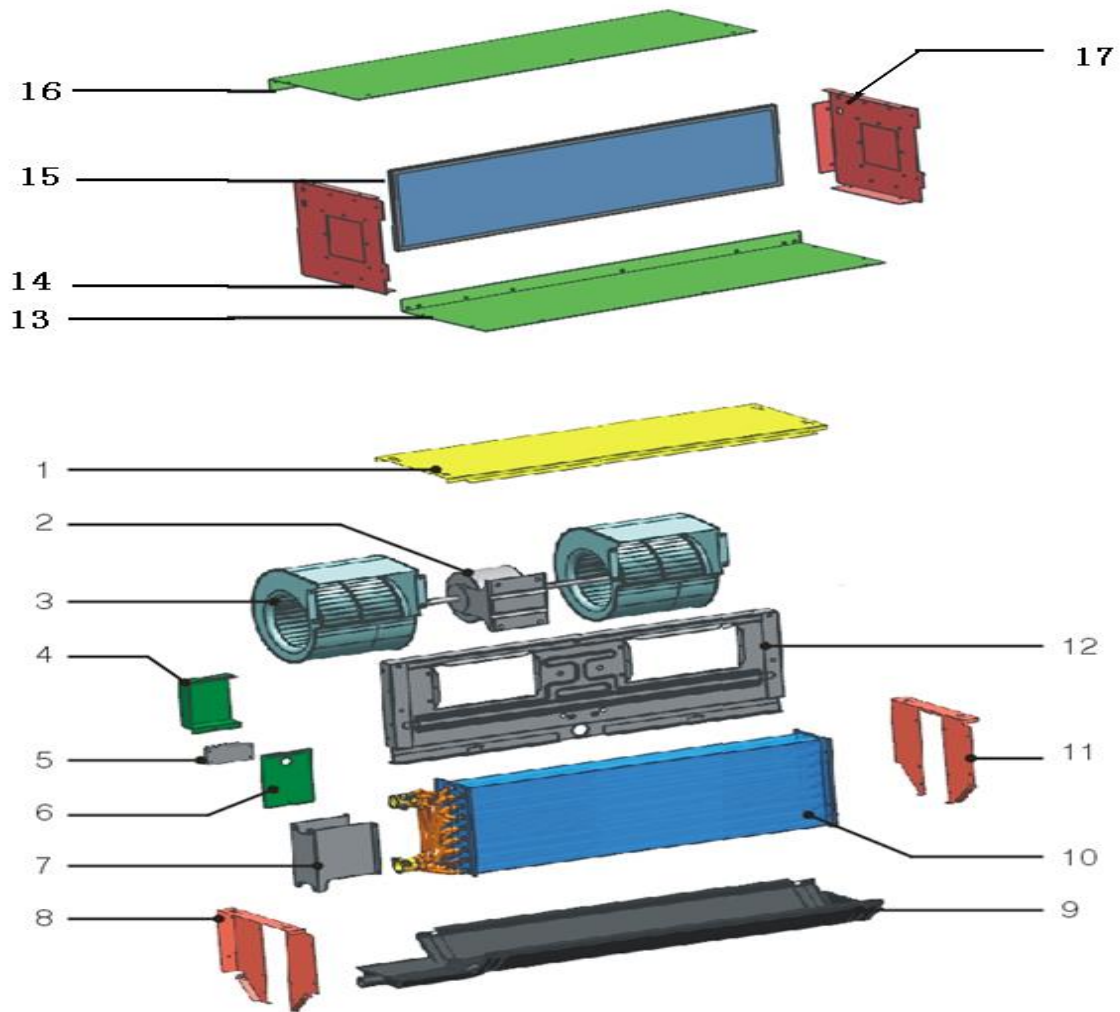

No.	Part Name	Quantity
1	Top panel ass'y	1
2	Motor ass'y	1
3	Fan ass'y	2
4	Motor junction box cover	1
5	Wire joint, 5p	1
6	Motor junction box	1
7	Water collector installation board	1
8	Left panel	1
9	Drain tray ass'y	1
10	Evaporater assembly	1
11	Right panel	1
12	Middle clapboard ass'y	1
13	Rear below cover plate ass'y	1
14	Left cover plate ass'y	1
15	Air filter	1
16	Up cover plate ass'y	1
17	Right cover plate ass'y	1

MDVF-800D304E, MDVF-1000D304E, MDVF-1200D304E, MDVF-1400D304E

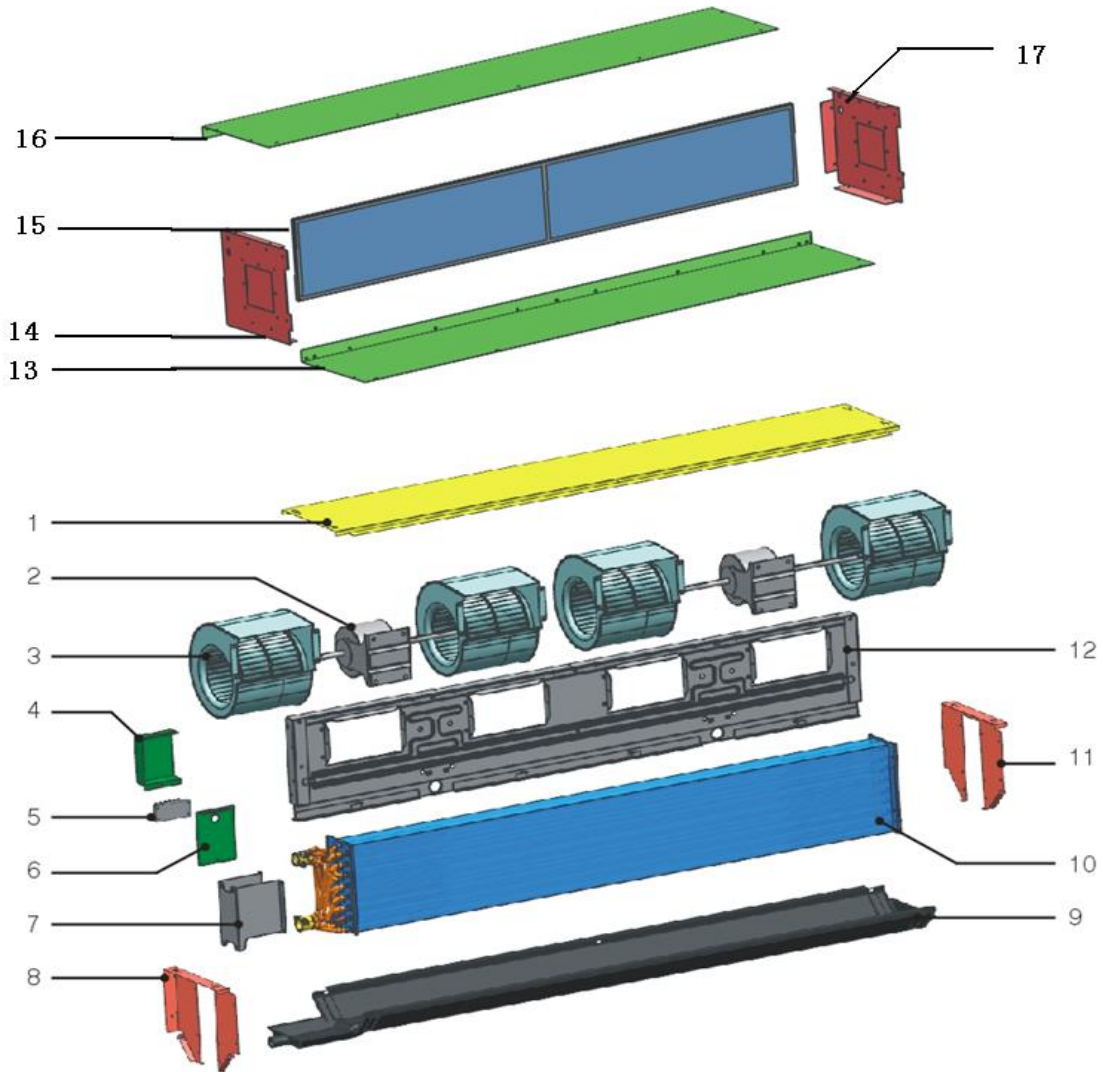

No.	Part Name	Quantity
1	Top panel ass'y	1
2	Motor ass'y	2
3	Fan ass'y	4
4	Motor junction box cover	1
5	Wire joint, 5p	1
6	Motor junction box	1
7	Water collector installation board	1
8	Left panel	1
9	Drain tray ass'y	1
10	Evaporater assembly	1
11	Right panel	1
12	Middle clapboard ass'y	1
13	Rear below cover plate ass'y	1
14	Left cover plate ass'y	1
15	Filter	1
16	Up cover plate ass'y	1
17	Right cover plate ass'y	1

13. Installation

13.1 Installing site

- ◆ Install the unit where installation and maintenance space is enough.
- ◆ Install the unit where the ceiling is horizontal and enough to bear the weight of the indoor unit.
- ◆ Install the unit where the air inlet and outlet are not baffled and are the least affected by external air.
- ◆ Install the unit where the supply air flow can be sent to all parts in the room.
- ◆ Install the unit where it is easy to lead out the connective pipe and the drain pipe.
- ◆ Install the unit where connotative heat is emitted from a heat source directly.

Caution:

Installing the equipment in any of the following places may lead to faults of the equipment (if that is inevitable, consult the supplier):

- The site contains mineral oils such as cutting lubricant.
- Seaside where the air contains much salt.
- Hot spring area where corrosive gases exist, e.g., sulfide gas.
- Factories where the supply voltage fluctuates seriously.
- Inside a car or cabin.
- Place like kitchen where oil permeates.
- Place where strong electromagnetic waves exist.
- Place where flammable gases or materials exist.
- Place where acid or alkali gases evaporate.
- Other special environments.

Precautions before installation:

- Decide the correct way of conveying the equipment.
- Try to transport this equipment with the original package.
- If the air conditioner needs to be installed on a metal part of the building, electric insulation must be performed, and the installation must meet the relevant technical standards of electric devices.

13.2 Installing body

- ◆ Confirm the dimensions of the indoor unit against the following figure.
- ◆ Install $\Phi 10$ pendant bolts (4 bolts).
- ◆ The intervals of the pendant bolts are shown in the following figure.
- ◆ Use the $\Phi 10$ pendant bolts.
- ◆ The treatment of the ceiling varies between buildings. For detailed measures, negotiate with the construction and fit-out staff.
 - Scope of dismantling the ceiling. Please keep the ceiling horizontal. Reinforce the beams and girders of the ceiling lest vibration of the ceiling.
 - Cut off the beams and girders of the ceiling.
 - Reinforce the cut-off part, beams and girders of the ceiling.
- ◆ After the main body is suspended, work on the pipes and wires in the ceiling. Decide the lead-out direction of the pipes after selecting the installation site. Especially, in a circumstance where a ceiling is available, extend the refrigerant pipe, drain pipe, indoor/outdoor connection wires and wire controller lines to the connection position before suspending the unit.

13.2.1 Procedure of installing the pendant bolts.

1) Base on the unit structure, please set the screw-pitch according to the size of the following figures:

■ Wooden structure:

Put rectangular sticks across the beams, and set pendant bolts.

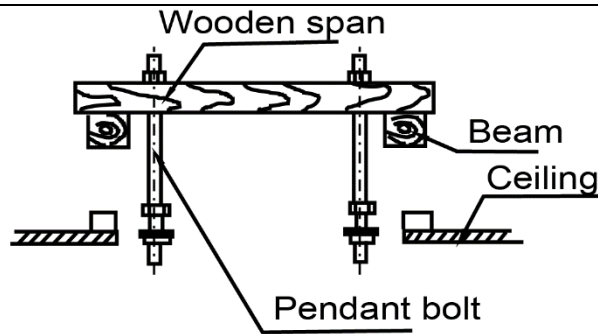

■ Old concrete roughcast:

Use embedded bolts and embedded pulling plugs.

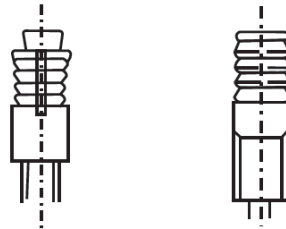

■ Steel beam and girder structure:

Set and use supportive angle steel.

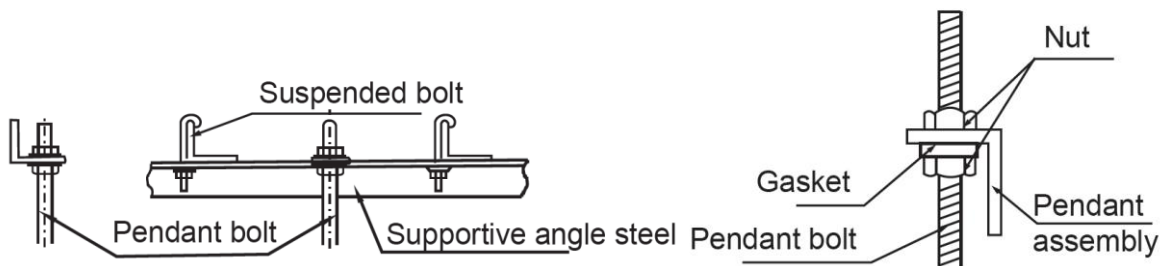

■ New concrete roughcast:

Set it with embedded bushes or embedded bolts.

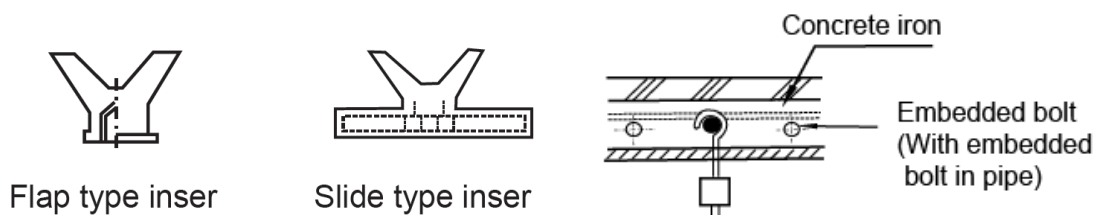

2) Suspending the indoor unit

- Use tools such as pulleys to hoist the indoor unit to the pendant bolt.
- Use tools such as gradient to settle the indoor unit horizontally. Lack of horizontality may cause water leak.

3) Connect the duct

The duct length is determined according to the external static pressure.

4) Install the wire control switch

For installation of the wire control switch, see the installation manual of the wire controller.

13.2.2 Body dimension

Please refer to chapter 7.

13.3 Installing extended drain pan

The grooves of the extended drain pan can be locked at the brim of the main drain pan.

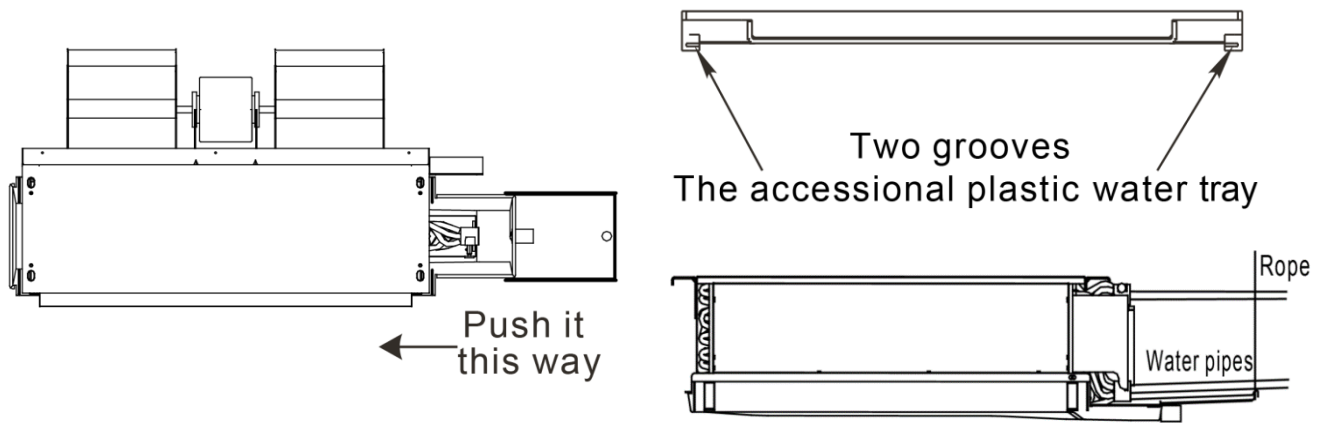

Please hang up the extended drain pan to the pipes or ceiling by a rope.

13.4 Installing water pipe

- ◆ With air release valve, the other side is water inlet pipe.
- ◆ When connect water collector, set the tightening torque to 6180~7540N.cm (630~770kgf.cm), and use a spanner to tighten it as shown in Figure.
- ◆ The diameter of connective junction in water inlet pipe and water outlet pipe is RC3/4 taper pipe thread inside.
- ◆ The diameter of condensate pipe is ZG3/4 taper pipe thread outside.

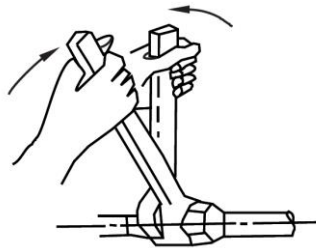

13.5 Installing drain pipe

- Install the drain pipe of the fan coil unit

Before out from factory, the scupper adopts the pipe thread.

CAUTIONS:

- Be sure to perform heat insulation for the drain pipe of the indoor unit. Otherwise, condensate will occur. The joint of the indoor unit should also undergo heat insulation treatment.
- When performing the pipes connection, use the rigid PVC binder, and make sure that no leak exists.
- Same as the joint of the indoor unit. Be careful not to apply force at the pipe side of the indoor unit.
- The downward gradient of the drain pipe should be higher than (1/100), without bend in the middle.
- The total length of the drain pipe should not exceed 20m, when the pipe is over long, a prop stand must be installed to prevent winging.
- The centralized pipes should be distributed against the figure shown on the right side.

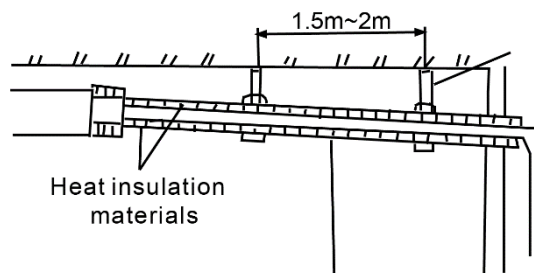

Downward gradient
is over 1/100

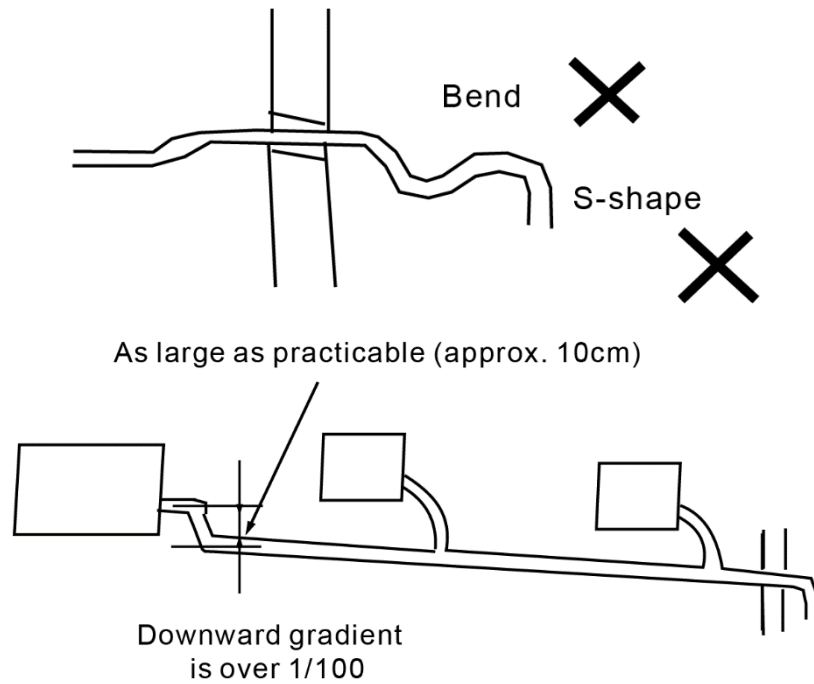

■ Drain test

Before the test, ensure that the drain pipes are smooth and the adapters are sealed. Newly built rooms should undergo the drain test before the ceiling is laid.

13.6 Wiring installation

CAUTIONS:

- The air conditioner should use separate power supply with rated voltage.
- The external power supply to the air conditioner should have ground wiring, which is linked to the ground wiring of the indoor and outdoor unit.
- The wiring work should be done by qualified persons according to circuit drawing.
- An all-pole disconnection device which has at least 3mm separation distance in all pole and a residual current device(RCD) with the rating of above 10mA shall be incorporated in the fixed wiring according to the national rule.
- The appliance shall be installed in accordance with national wiring regulations.
- Be sure to locate the power wiring and the signal wirings well to avoid cross-disturbance.
- Do not turn on the power until you have checked carefully after wiring.







The wiring connection please refers to chapter 8.

14.Accessories

14.1 Standard accessories

Accessory name	Qty.	Shape	Usage
Owner's & installation manual	1	/	Installation guide
Extended drain pan	1		Connect drain water from valve kit

14.2 Optional accessories

Accessory name	Qty.	Shape	Usage
PCB control kit CE-FCUKZ-03	1		Electric control
Remote controller R05/BGE	1		Remote control
Remote controller R51/E	1		Remote control
Wired controller KJR-18B/E	1		Wired control
Wired controller KJR-21B/D	1		Wired control
Central controller CCM03	1		Central control

14.2.1 PCB control kit for FCU**1. Specifications**

Model	CE-FCUKZ-03	CE-FCUKZ-04
Available appliance	2-pipe ducted FCU	4-pipe ducted FCU
Power supply	220-240V-1Ph-50Hz	
Operation range	Room temperature	17°C~30°C
	Inlet water temperature	3°C~75°C
Temperature controlling precision	±1°C	
Dimension (W×H×D)	296x66x212	
Packing Size (W×H×D)	410x115x262	

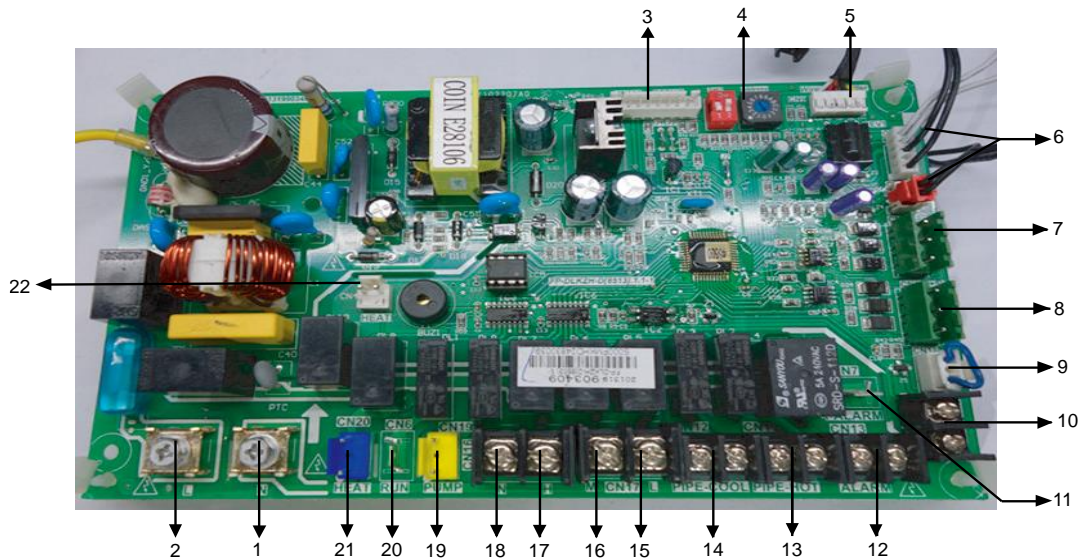

2. Internal View



Note: CE-FCUKZ-03 adopts one valve switch, CE-FCUKZ-04 adopts two valve switches. When installing CE-FCUKZ-04 should connect the valve switch (CN12:PIPE-COOL and CN11: PIPE-HOT) and temp sensor (CN5:T1,T2-COOL and CN8:T2-HEAT), and place connects respond to the wiring nameplate.

- T1 is indoor temperature sensor, install to the air inlet of the indoor unit.
- T2-COOL,T2-HEAT is pipe temperature sensor.

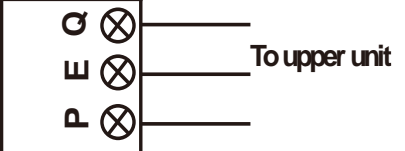
No.	Detail information																	
1, 2	*L: Live wire *N: Netrual wire Power in: 220V-240V~, 50Hz/60Hz																	
3	CN300: DEBUG PORT																	
4	SW2, ENC1: Network address set, every air-conditioner in network has only one network address to distinguish each other, the set range is 0-63, please see the table blow. <table border="1" style="margin: 10px auto;"> <thead> <tr> <th colspan="2">Toggle switch set</th> <th rowspan="2">Network address code</th> </tr> <tr> <th>SW2</th> <th>ENC1</th> </tr> </thead> <tbody> <tr> <td></td> <td></td> <td>00~15</td> </tr> <tr> <td></td> <td></td> <td>16~31</td> </tr> <tr> <td></td> <td></td> <td>32~47</td> </tr> <tr> <td></td> <td></td> <td>48~63</td> </tr> </tbody> </table>	Toggle switch set		Network address code	SW2	ENC1			00~15			16~31			32~47			48~63
Toggle switch set		Network address code																
SW2	ENC1																	
		00~15																
		16~31																
		32~47																
		48~63																
5	CN9: Connect to wire controller.																	
6	CN5: T1, room temperature sensor (if fault, the wire controller light will flashes two times at 2Hz, stop 2s); CN5: T2-COOL, pipe temperature sensor of condenser (if fault, the wire controller light will flashes three times at 2Hz, stop 2s); *CN8: T2-HEAT, pipe temperature sensor of condenser (if fault, the wire controller light will flashes three times at 2Hz, stop 2s); *T2-HEAT, only using in CE-FCUKZ-04.																	

7	<p>CN10: MOBUS RTU port: Connect to BMS control. 3-core shielded cable should be used. Interconnected P, Q, E wires and the shielding layer of the communication wires should be grounded.</p>	
8	<p>CN14: Centralized control port: Connect to centralized controller. 3-core shielded cable should be used. Interconnected X, Y, E wires and the shielding layer of the communication wires should be grounded.</p>	
9	<p>CN18: water-level switch (if fault, the wired controller light will flashes four times at 2Hz, stop 2s)</p>	
10	<p>CN3: ON/OFF port, disconnect, the long-distance control function is invalid; when connect, the wire controller and centralized controller are invalid and system is equivalent of shutdown.</p>	
11	<p>CN7: I-ALARM port, high voltage signal output, when system run normal (strong AC signal output)</p>	
12	<p>CN13: ALARM port, high voltage signal when a alarm output (strong AC signal output).</p>	
13	<p>*CN11: PIPE-HOT port, hot water valve, only using in CE-FCUKZ-04 (strong AC signal output).</p>	
14	<p>CN12: PIPE-COOL port, cool water valve, using in CE-FCUKZ-03 or CE-FCUKZ-04 system in central air conditioner (strong AC signal output)</p>	
15	<p>CN17: L, connect to indoor fan unit, low fan speed (strong AC signal output)</p>	
16	<p>CN17: M, connect to indoor fan unit, medium fan speed (strong AC signal output)</p>	
17	<p>CN16: H, connect to indoor fan unit, high fan speed (strong AC signal output)</p>	
18	<p>CN16: N, connect to nutral wire.</p>	
19	<p>CN19: PUMP (strong AC signal output).</p> <ol style="list-style-type: none"> 1) After receiving start-up instruction and set in COOL, DRY mode, the pump will be started up instantly, and will maintain start-up state always in the process of operation. 2) To turn it off or transferred to other mode, the pump will be shut down 3 minutes after all modules stop operating. 	
20	<p>CN6: RUN, high voltage signal output when the system run normal (strong AC signal output).</p>	
21	<p>CN20: HEAT (strong AC signal output).</p> <p>Attention: the control port value of the CN20(HEAT) is STRONG AC signal output but can not drive electric heating directly. So special attention should be paid when installing this heat. Electric heating needs to be connected with 220V-240V~ power supply externally.</p>	
22	<p>CN4: HEAT (DC +12V output).</p> <p>Attention: the control port value of the CN4(HEAT) actually detected is DC 12V signal output and can not drive electric heating directly, so special attention should be paid when installing this heat.</p> <p>DC +12V control signal output by PCB can start/stop the external relay, thereby to start/stop e-heating pipe.</p> <p>Electric heating needs to be connected with 220V-240V~ power supply externally.</p>	

* CE-FCUKZ-03: Condenser Temp. sensor number is 1;

CE-FCUKZ-04: Condenser Temp. sensor number is 2.

* L、N Port: Strongly recommend using Ring Terminal or Spade Terminal to connect.

3. Main features

- Suitable for 2-pipe and 4-pipe FCU.
- Installation flexible, it can be installed attaching on the unit, mounting on the wall or hanging under the ceiling.
- Maintenance convenient for its external installed.
- Three fan speeds adjustment: high/medium/low.
- Operating status can be displayed form lamp indicator.
- Network Interface Module standard, compatible with the CCM control and PC based software control.

4. Compatible control type

Model	Applicable appliance	Remote control	Wired control	Central control	PC based network control
CE-FCUKZ-03	2-pipe ducted FCU	√	√	√	√
CE-FCUKZ-04	4-pipe ducted FCU	√	√	√	√

5. Application control**5.1 Fan speed adjustment function 3 files**

Available wire controller to select high, medium and low three operation modes.

5.2 Long-distance control and alarm functions

- Refer wiring diagram connected CN13 port to achieve fault alarm function.
- Through regulating CN3 port status to realize long-distance control function.
- When CN3 disconnect, the long-distance control function is invalid;
- When CN3 connect, the wire controller and Centralized Controller is invalid and the system is equivalent of shutdown.

5.3 Centralized control

Centralized control through the CCM03, please refer to the "Centralized control owner's & Installation Manual"

6. Trouble shooting

Before asking for serving or repairing, check the following points.

Symptoms	Causes	Solution
Unit does not start	Power failure; Power switch is off; Fuse of power switch may have burned; Batteries of remote controller exhausted or other problem of controller.	Wait for the comeback of power; Switch on the power; Replace the fuse; Replace the batteries or check the controller.
The fan speed cannot be changed.	Check whether the MODE indicated on the wire controller monitor is "DRY".	When dry operation is selected, the air conditioner changes the fan speed automatically. The fan speed can only be selected during "COOL", "FAN" and "HEAT".
Air flowing normally but completely can't cooling	Temperature is not set correctly.	Set the temperature properly.
Low cooling effect	Indoor unit heat exchanger is dirty; The air filter is dirty; Inlet of indoor unit is blocked; Doors and windows are open; Sunlight shine directly; Too many heat resources.	Clean the heat exchanger; Clean the air filter; Eliminate all dirties and make air smooth; Close doors and windows; Make curtains in order to shelter from sunshine; Reduce heat resource.
Low heating effect	Doors and windows are not completely closed.	Use heating device; Close doors and windows.

7. Malfunctions and malfunction code

If anything happens like the situation described below, please shut off the power supply of the unit and contact with the customer service center immediately.

NO.	Malfunction	The wire controller light
0	Normal	On
1	Eeprom malfunction	Flashes one times at 2Hz, stop 2s
2	Roomtemperature sensor checking channel is abnormal.	Flashes two times at 2Hz, stop 2s
3	Evaporator temperature sensor checking channel is abnormal. (four-pipe water system COOL MODE: T2-COOL ; HEAT MODE: T2-HEAT)	Flashes three times at 2Hz, stop 2s
4	Water-level switch malfunction	Flashes four times at 2Hz, stop 2s

14.2.2 Optional remote controller: R05/BGE

Operation section

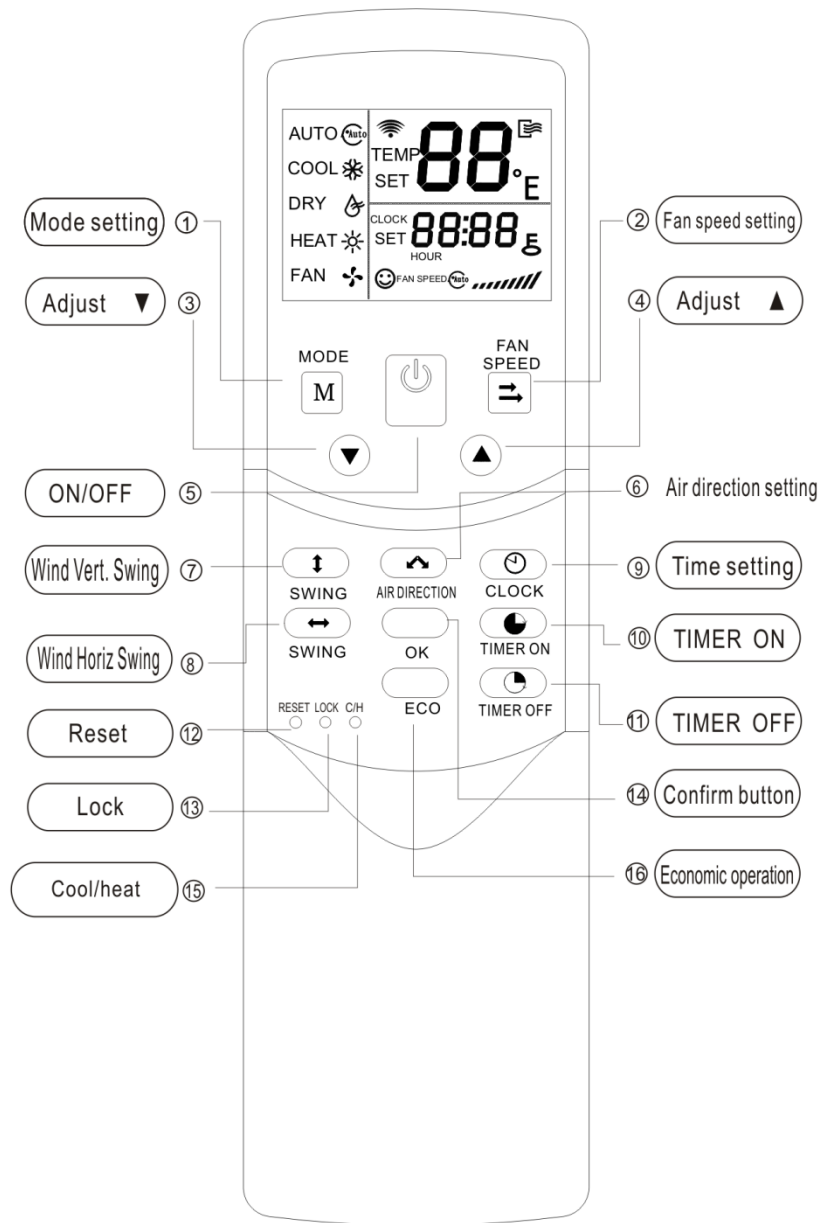

Display section

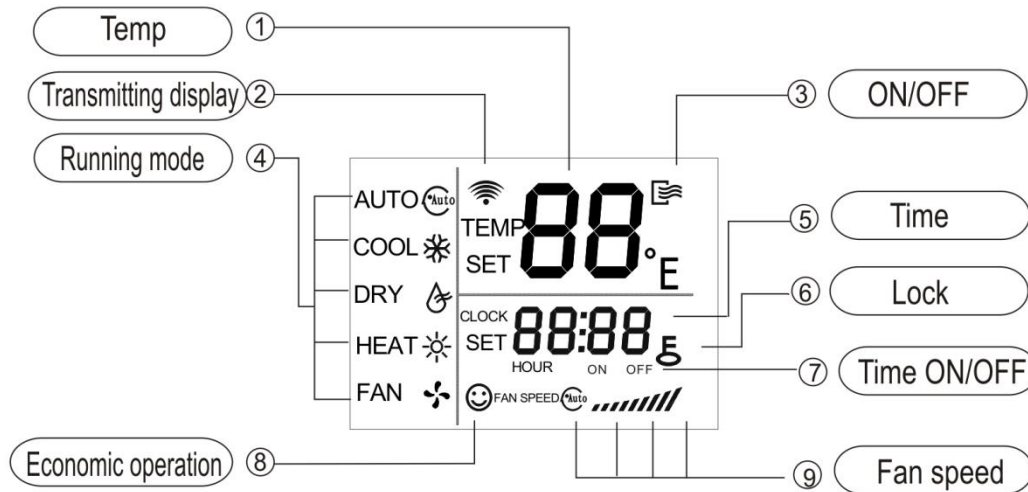

1. How to operate

- **MODE:** Once pressing, running mode will be selected in the following sequence:

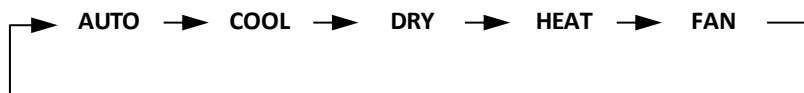

NOTE: No heating mode for cool only type unit.

- **FAN SPEED:** Fan speed will be selected in following sequence once pressing this button:

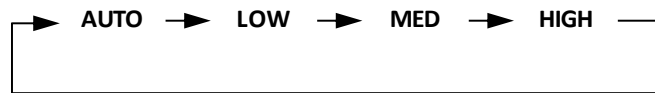

- **Adjust:** Decrease the set temp. Keeping pressing will decrease the temp with 1°C per 0.5s.
- **Adjust:** Increase the set temp. Keeping pressing will increase the temp with 1°C per 0.5s.
- **ON/OFF:** For turning on or turning off the air conditioner.
- **AIR DIRECTION:** Activate swing function of air deflector. Once pressing, air deflector will turn 6°C. For normal operation and better cooling and heating effect, deflector will not turn to the degree which is the state of deflector when the unit is turned off. (Only available when remote controller is used with corresponding unit.)
- **HORIZ SWING:** Activate or turn off horizontal swing function. (Only available when remote controller is used with corresponding unit.)
- **VERT SWING:** Activate or turn off vertical swing function. (Only available when remote controller is used with corresponding unit.)
- **CLOCK:** Display the current time. (12:00 is displayed when resetting or electrifying for the first time.) Press CLOCK for 5s, icon indicating hour will flash with 0.5s. Press it again, ▼ and ▲ are used to adjust the figure. Setting or modification is effective only by pressing OK button to make confirmation.
- **TIME ON:** For time ON setting. Once pressing this button, the time will increase by 0.5 hour. When the set time exceeds 10 hours, pressing the button will increase the time by 1 hour. Adjusting the figure to 0.00 will cancel time ON setting.
- **TIME OFF:** For time OFF setting. Once pressing this button, the time will increase by 0.5 hour. When the set time exceeds 10 hours, pressing the button will increase the time by 1 hour. Adjust the figure to 0.00 will cancel time ON setting.
- **RESET (inner located):** Press this button with a needle of 1mm to cancel the current setting and reset remote controller.

- **LOCK (inner located):** Press this button with a needle of 1mm to lock or unlock the current setting.
- **OK:** Used to confirm the time setting and modification.
- **COOL/HEAT (inner located):** Press this button with a needle of 1mm to shift mode between COOL only and COOL&HEAT.
During setting, back light will be lightened. Factory default mode is COOL &HEAT.
- **ECO:** Activate or turn off economic operation mode. It is suggested to turn on this function when sleeping. (Only available when remote controller is used with corresponding unit.)

2. Specifications

Model	R05/BGE
Rated Voltage	3.0V
Lowest Voltage of CPU Emitting Signal	2.4V
Reaching Distance	8m (when using 3.0 voltage, it can get 11m)
Environment Temperature Range	-5°C~60°C

14.2.3 Optional remote controller: R51/E

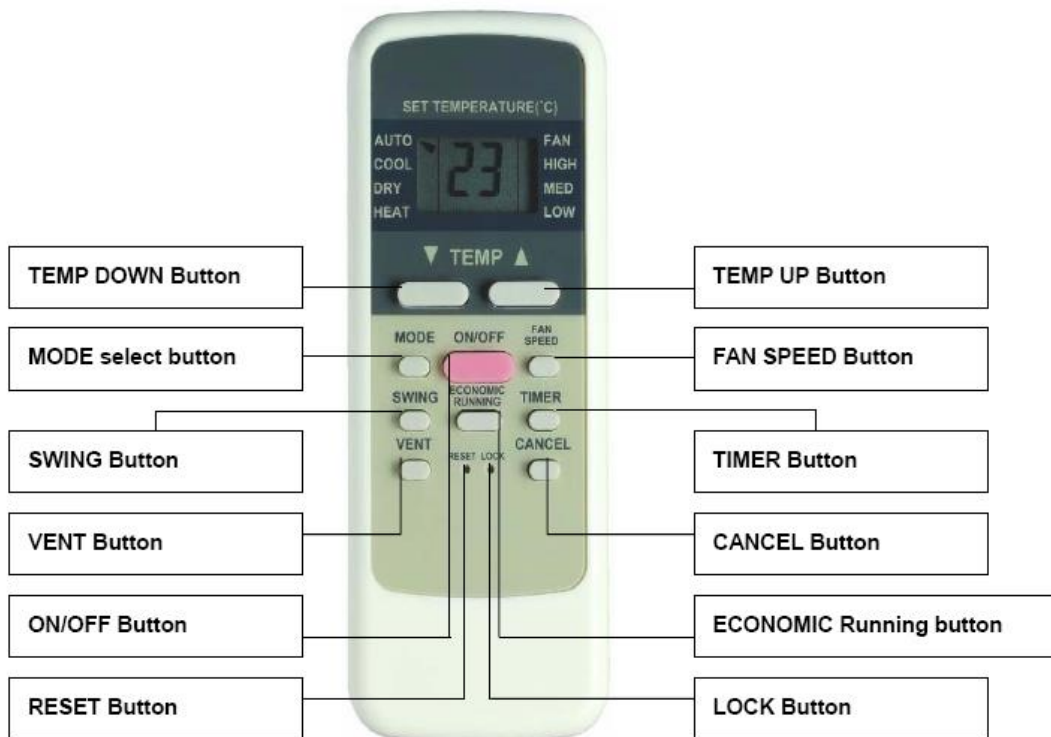

1. How to operate

- **TEMP DOWN Button:** Push the TEMP DOWN button to decrease the indoor temperature setting or to adjust the timer in a counter-clockwise direction.
- **MODLE SELECT Button:** Each time you push the button, a mode is selected in a sequence that goes from AUTO, COOL, DRY, HEAT and FAN as the following figure indicates:



NOTE: HEAT only for Heat Pump.

- **SWING Button:** Push this switch button to change the louver angle.
- **RESET Button:** When the RESET button is pushed, all of the current settings are cancelled and the control will return to the initial settings.
- **ECONOMIC RUNNING Button:** Push this button to go into the Energy-Saving operation mode.
- **LOCK Button:** Push this button to lock in all the current settings. To release settings, push again.
- **CANCEL Button:** Push this button to cancel the TIMER settings.

- **TIMER Button:** This button is used to preset the time ON (start to operate) and the time OFF (turn off the operation)
- **ON/OFF Button:** Push this button to start the unit operation. Push the button again to stop the unit operation.
- **FAN SPEED Button:** This button is used for setting fan speed in the sequence that goes from AUTO, LOW, MED to HIGH, and then back to Auto.
- **TEMP UP Button:** Push this button to increase the indoor temperature setting or to adjust the timer in a counter-clockwise direction.
- **VENT Button:** Push this button to set the ventilating mode. The ventilating mode will operate in the following sequence:

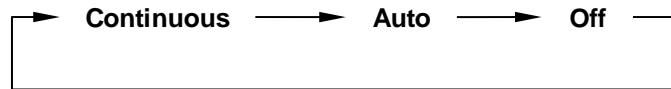

NOTE: Ventilation Function is available for the Fresh Star Series.

2. specifications

Model	R51/E
Rated Voltage	3.0V
Lowest Voltage of CPU Emitting Signal	2.0V
Reaching Distance	8m (when using 3.0voltage, it can get 11m)
Environment Temperature Range	-5°C~60°C

14.2.4 Optional wired controller for ducted units without electric heater: KJR-18B/E

1. Models

KJR-18B/E is a thermostat that has developed into 4 types. Each type has its own features to suit different environment.

Models	Features
KJR-18B/E-A	Only control 3-speed fan, when the temperature reaches the set-point, it will close the Fan.
KJR-18B/E-B	Control motorized valve and 3-speed fan, when the temperature reaches the set-point, it will close the motorized valve and fan both
KJR-18B/E-C	Control motorized valve and 3-speed fan, when the temperature reaches the set-point, it will close the motorized valve with the fan still running
KJR-18B/E-D	Control 4 pipe fan coil units, control two motorized valves and 3-speed fan, when the temperature reaches the set-point, it will close the motorized valves with the fan still running.

2. Specifications

Model	KJR-18B/E
Available appliance	Ducted FCU without electrical heater
Power supply	AC220V±10%-1Ph-50/60Hz
Operating temperature	0~45°C
Operating Humidity	5~90%RH
Temperature controlling range	10~30°C
Temperature controlling precision	±1°C
Dimension (H×W×D)	130×85×43mm

3. Installation

1) Dismantle the front panel

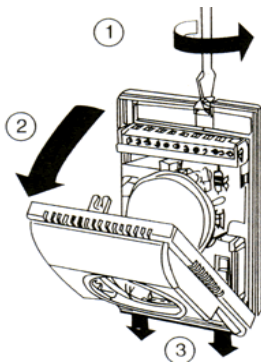

2) Dismantle te middle part

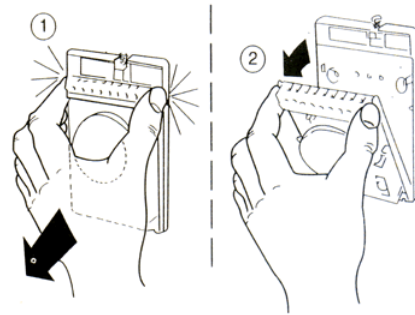

3) Install the back base

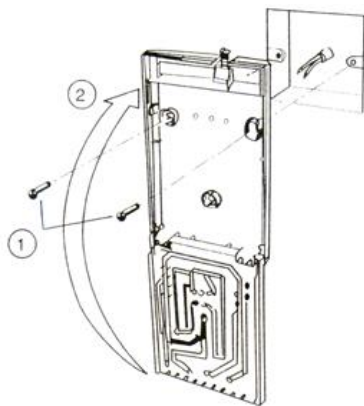

4) Wire Connection

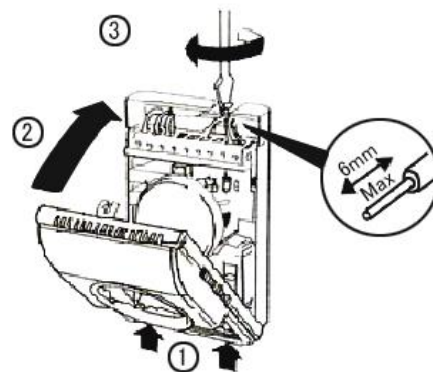

4. Wiring diagrams:

KJR-18B/E-A KJR-18B/E-B KJR-18B/E-C

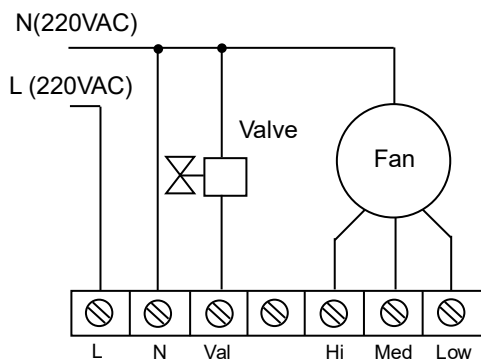

2-wireNCvalve system
(KJR-18B/E-A without Motorized Valve)

KJR-18B/E-D

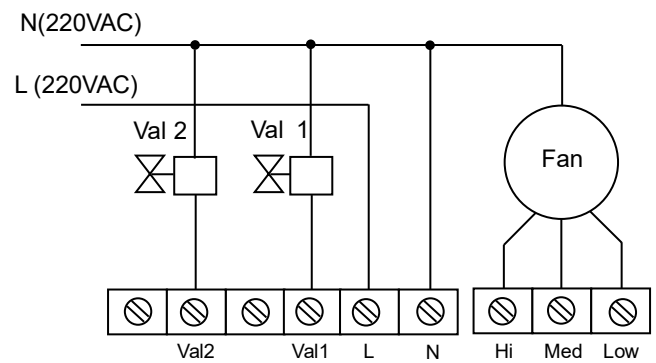



Val1: For heating Val2: For cooling
2-wire NC valve system

Note: Please confirm the model and use corresponding wiring diagram above when you wire.

14.2.5 Optional wired controller for ducted units with electric heater: KJR-21B/D



KJR-21B/D is available for ducted FCU with electric heater. It has large LCD display which can display: working mode (cooling, heating and ventilation), fan speed, room temperature, setting temperature, etc. The buttons on the panel

are : on/off (), mode exchange (M), timer (⊕), fan speed () and temperature adjustment (▲ ▼)



Function:

- Available for ducted FCU with electric heater
- Blue backlight
- Clock display
- Temperature setting
- Mode setting : cool/heat/fan/electric heating on/off
- Fan speed setting: auto/high/medium/low
- Motorized valve control
- Electric heating control
- Remote control (optional)

Specifications:

- Power supply : AC220V ± 10%, 50/60Hz
- Power consumption: < 2W
- Current load: < 2A
- Temperature controlling range: 5~35°C
- Temperature controlling precision: ± 1°C
- External dimension: 86×86×13 mm (W×H×D)
- Installation hole pitch: 60mm (standard)

Installation

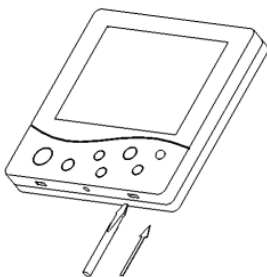

1. Open the panel by screwdriver

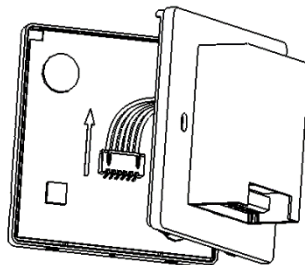

2. Disassemble the wires

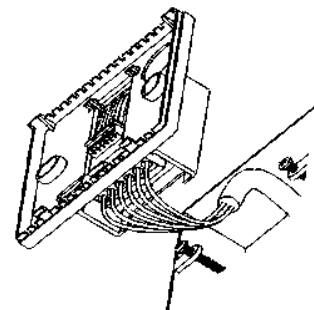

3. connect the wires to terminals by screwdriver

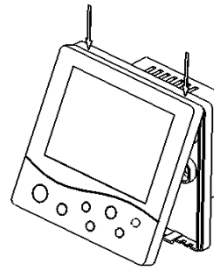
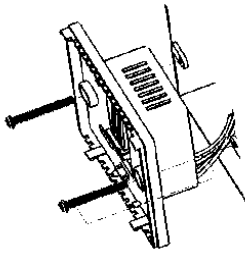







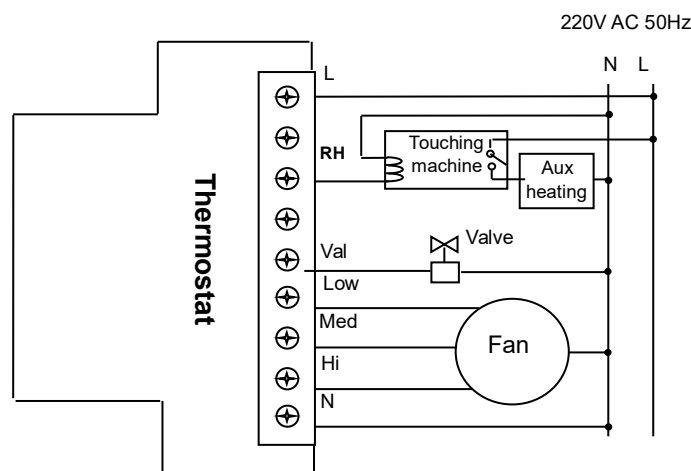







4. Put the back panel into the wall, then fix it with two screws in the packing box. Install main control panel wires.

5. Install main control panel wires. Put the cover with 30 degree angle, then fix the up two clips. Push the palces of two down clips, fix the cover, and finish the installation.

Wiring diagram:



How to operate

On/off	Press “  ” to turn on, press “  ” again to turn off.
Temperature setting	Press “  ” to reduce temperature, press “  ” to raise temperature; each time, temperature will change 1°C.
Cooling	Press “M” until it displays  and flash, it will be confirmed automatically after 5 seconds.
Heating	Press “M” until it displays  and flash, it will be confirmed automatically after 5 seconds.
Ventilation	Press “M” until it displays  and flash, it will be confirmed automatically after 5 seconds.
Electric heating on/off	(Only available on heating mode) In heating mode, When the room-temperature is 2°C lower than the set-temperature, The electric heating will be on and thermostat will display “  ”, meanwhile valve is off automatically. When the room-temperature is 1°C higher than the set-temperature, The electric heating will be off automatically and “  ” will not be displayed.
Valve control	In cooling mode, When the set-temperature is equal or 1°C higher than the room-temperature, the valve will be on; When the set-temperature is equal or 1°C lower than the room-temperature, the valve will be off.
Fan speed	Press “  ” to select “  ”(Hi),  ”(Med),  ”(Low),  ”(Auto). In “  ”(Auto)”mode, the fan-speed changed automatically. LOW-speed When the difference between room-temperature and set-temperature exceed 1°C, MED-speed When exceed 2°C, HI-speed When exceed 3°C. When the electric heating is turned on, The LOW-speed is invalid, MED-speed when the set-temperature is lower than room-temperature, HI-speed when equal or exceed 3°C.

<p>Timer on/off</p>	<p>Timer on: Press “⊕”, until it displays “⊕”, “TIMER ON” flashes, and “mm” of “hh:mm” flashes, press “▲” or “▼” to adjust the minutes, press “⊕”, “hh” of “hh:mm” flashes, press “▲” or “▼” to adjust the hours.</p> <p>Timer off: Press “⊕”, until it displays “⊕” “TIMER OFF” flashes, and “mm” of “hh:mm” flashes, press “▲” or “▼” to adjust minutes, press “⊕”, “hh” of “hh:mm” flashes, press “▲” or “▼” to adjust the hours.</p> <p>Notes: If your setting is accepted by thermostat, The “TIMER ON/OFF” will be displayed on LCD.</p> <p>Cancel the time on/off function: For unused periods, set the ON and OFF time to “00.00”.</p> <p>Temperature Calibration:</p> <p>When the displayed temperature is not correct. With the thermostat in turned off, Press “M” and “⊕” for 3 seconds. The display will show “XX” °C. Press “▲” or “▼” to adjust the temperature to the correct value. It will be confirmed after 5 seconds</p>
----------------------------	---

14.2.6 Optional central controller: CCM03



MD-CCM03 is a multifunctional device which is able to control up to 64 indoor units. And the connection length can be up to 1,200m as follow:

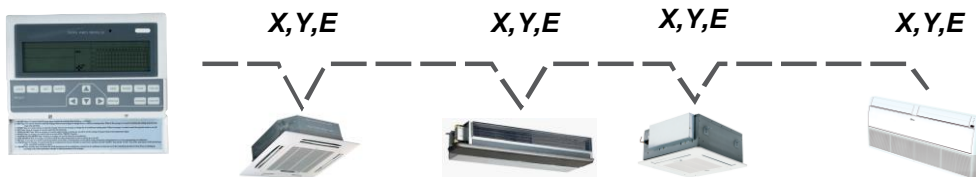

Access to network monitoring

MD-CCM03 is able to bridge up to 64 indoor units to the network monitoring system and the building management system as follow:

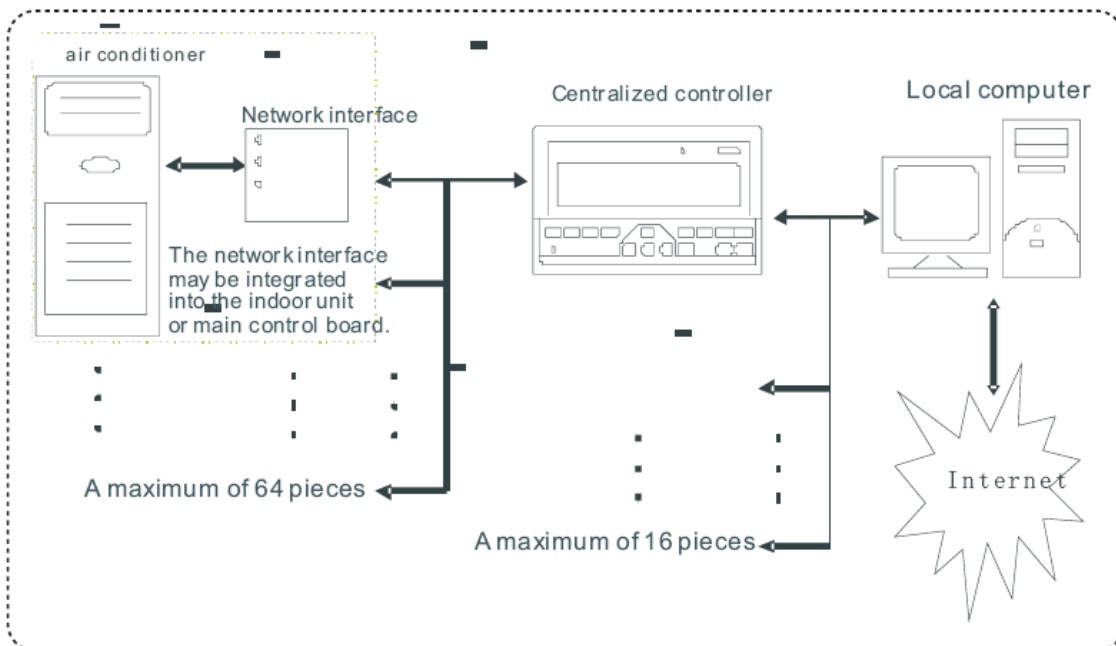

Full display of LCD

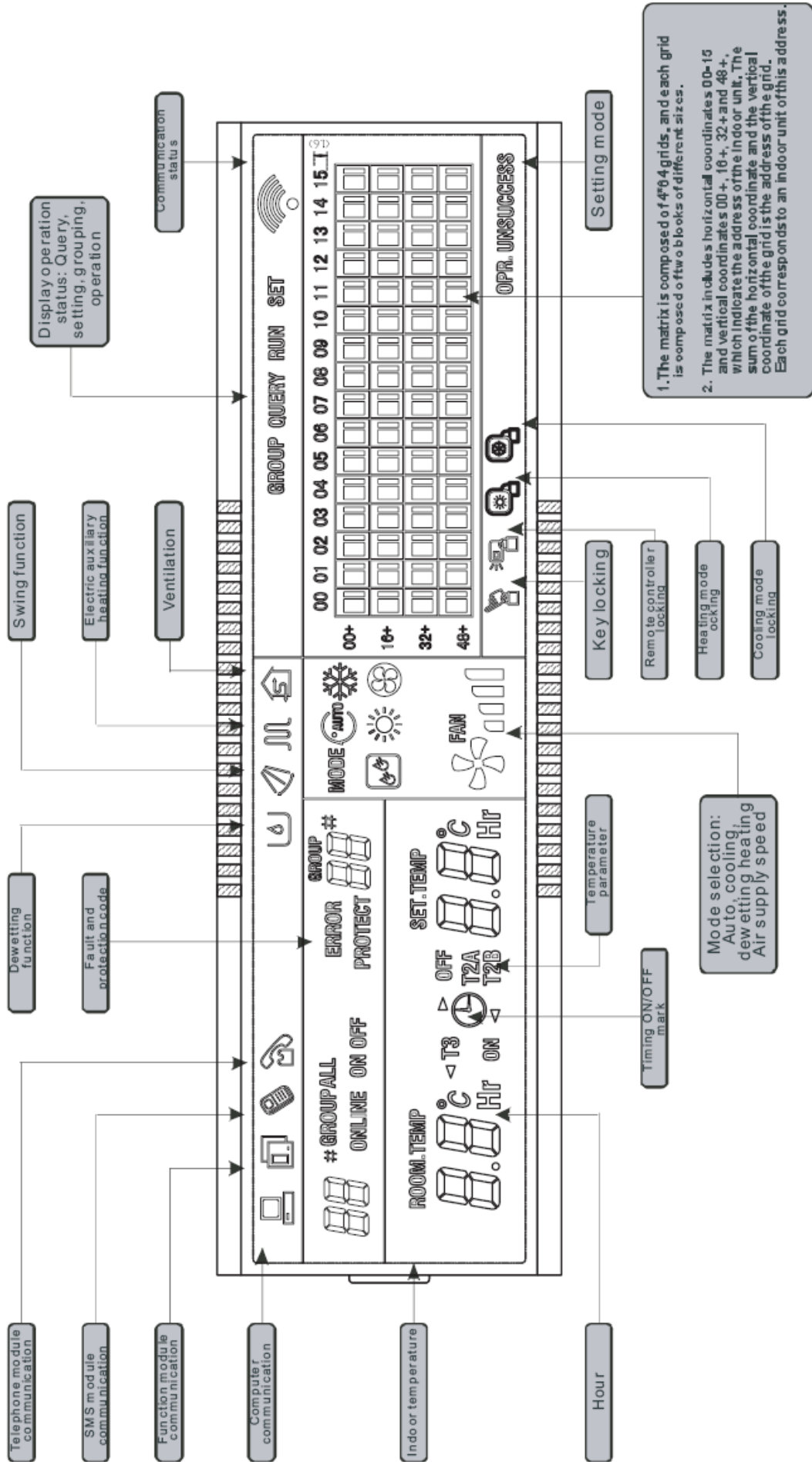

Liquid crystal matrix display description:

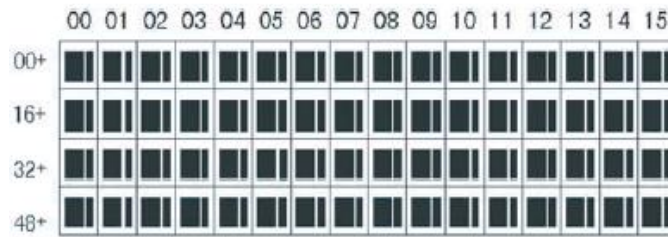

- ◆ The liquid crystal matrix is composed of 4×64 grids, and each grid is composed of two blocks of different sizes (as shown in the above figure).
- ◆ The matrix includes horizontal coordinates 00-15 on the upper side and vertical coordinates 00+, 16+, 32+ and 48+ on the left side, which indicate the address of the indoor unit. The sum of the horizontal coordinate and the vertical coordinate of the grid is the address of the grid. Each grid corresponds to an indoor unit of this address.
- ◆ One grid is composed of two blocks of different sizes. The status indication table is as follows:

Status	Constantly on	Slow blink		Fast blink
Object	Constantly on	Slow blink		Fast blink
Big black block	In-service	Selected		Out of service
Small black block	Power on		Fault of indoor unit	Power off

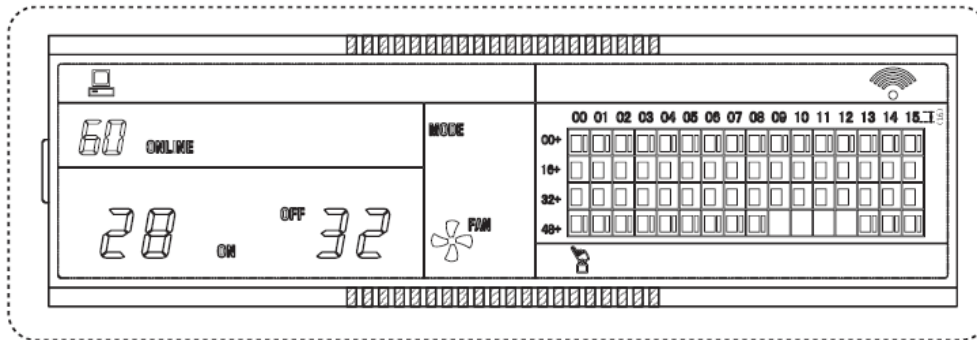

LCD display description

Description of the standby page

- 1) The LCD displays the standby page, 60 air conditioners are in service, of which 28 are powered on and 32 off.
- 2) In the matrix, the big dots of (00, 16+) and (15,32+) are luminous, and the small dots are not luminous. It indicates the 32 air conditioners with the addresses from 16 to 47 are powered off.
- 3) In the matrix, the big and small dots of (09, 48+) and (12, 48+) are not luminous. It indicates the four air conditioners with the addresses from 57 to 60 are outside the network.
- 4) All other big and small dots in the matrix are luminous. It indicates all other air conditioners are in the network and powered on.
- 5) The address of the air conditioner is sum of the coordinates. For example, the address of (09, 48+) is 09+48=57.
- 6) The centralized controller keypad is locked, and the centralized controller communicates with the computer normally.

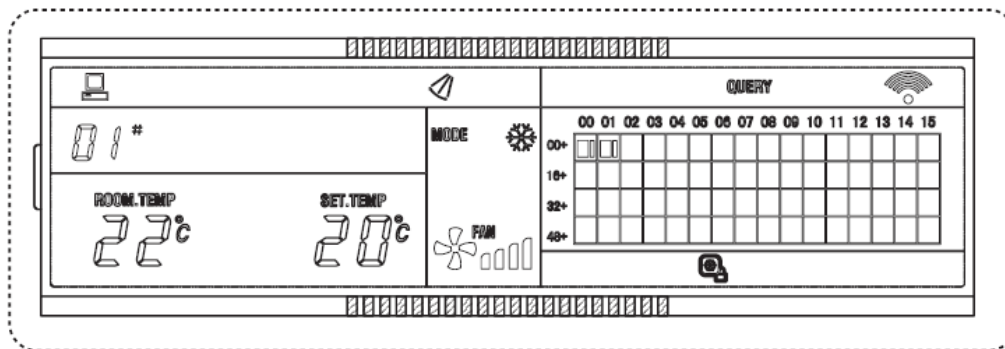

Query page description

- 1) The LCD displays the query page, and the air conditioner with the address of 08 is being queried. Mode of the air conditioner with the address 01 is: Cooling, strong air, swing on, indoor temperature 22°C, set temperature 20°C, cooling mode “lock”.
- 2) In the matrix, only the big and small black dots at (00, 00+) and (01, 00+) are luminous. It indicates the in-service and power-on status of the air conditioners with the addresses of 00 and 01.
- 3) The centralized controller communicates with the computer normally.

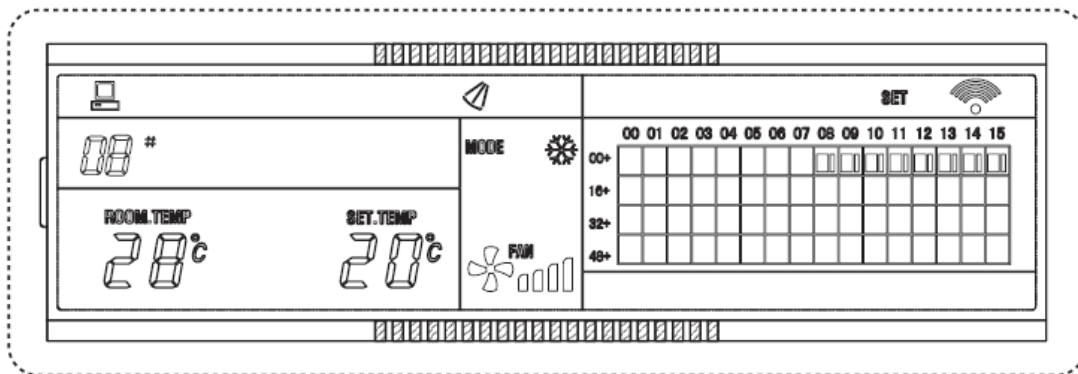

Setting page description

- 1) The LCD displays the setting page, and queries the air conditioner with the address of 08. The mode of the air conditioner with the address 08 is: Cooling, strong air, swing on, indoor temperature 28°C, set temperature 22°C, cooling.
- 2) In the matrix, only the big black dots from (08, 00+) to (16, 00+) are luminous. It indicates the air conditioners with the addresses from 08 to 16 are in service.
- 3) The centralized controller communicates with the computer normally.

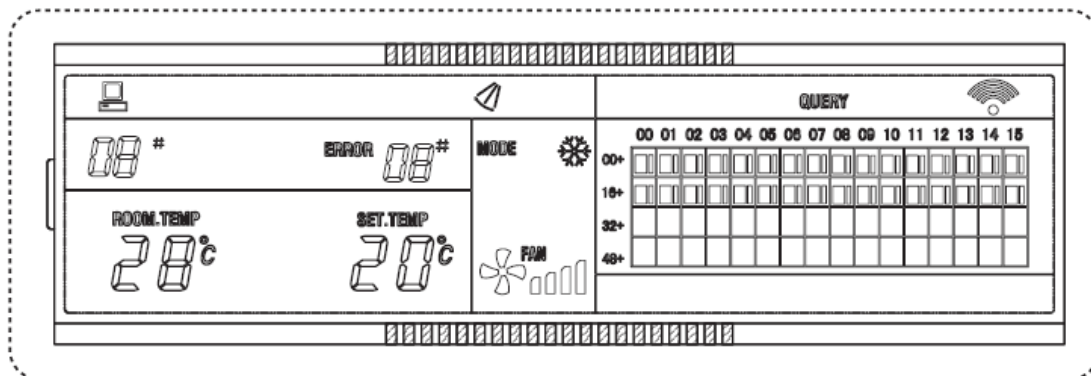

Fault page display description

- 1) Query the air conditioner with the address of 08 in the query page. The air conditioner with the address of 08 is faulty, and the fault code is 08. The big black dot below (08, 0+) blinks.
- 2) In the matrix, only the big and small black dots from (00, 00+) to (16, 15+) illuminate. It indicates the in-service status of the air conditioners with the addresses of 00 and 01.
- 3) The centralized controller communicates with the computer normally.